

# TinyLogic ULP-A Triple Buffer

## NC7NP34

The NC7NP34 is a triple buffer in tiny footprint packages. The device is designed to operate for  $V_{CC} = 0.9\text{ V}$  to  $3.6\text{ V}$ .

### Features

- Designed for 0.9 V to 3.6 V  $V_{CC}$  Operation
- 2.7 ns  $t_{PD}$  at 3.3 V (Typ)
- Inputs/Outputs Over-Voltage Tolerant up to 3.6 V
- $I_{OFF}$  Supports Partial Power Down Protection
- Source/Sink 2.6 mA at 3.3 V
- Available in US8 and MicroPak™ Packages
- These Devices are Pb-Free, Halogen Free/BFR Free and are RoHS Compliant

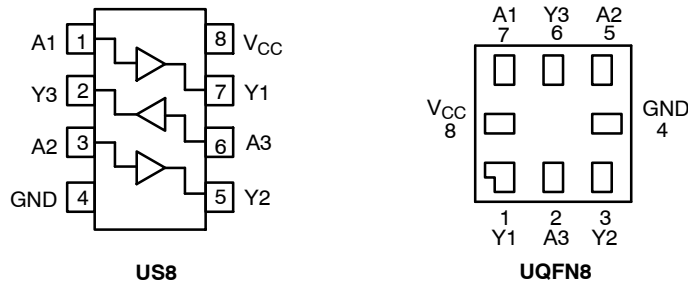

Figure 1. Pinout Diagrams (Top Views)

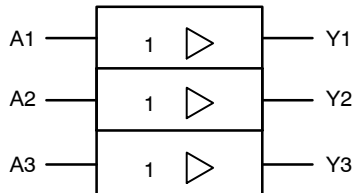

Figure 2. Logic Symbol

### PIN ASSIGNMENT

Pin	US8	UQFN8
1	A1	Y1
2	Y3	A3
3	A2	Y2
4	GND	GND
5	Y2	A2
6	A3	Y3
7	Y1	A1
8	$V_{CC}$	$V_{CC}$

### FUNCTION TABLE

A Input	Y Output
L	L
H	H



ON Semiconductor®

[www.onsemi.com](http://www.onsemi.com)

### MARKING DIAGRAMS

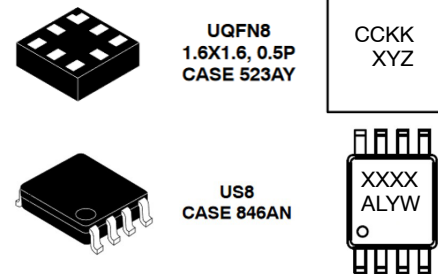

CC,XXX = Specific Device Code  
 KK = 2-Digit Date Code Traceability Code  
 XY = 2-Digit Date Code Format  
 Z = Assembly Plant Code  
 A = Assembly Site  
 L = Wafer Lot Number  
 YW = Assembly Start Week

### ORDERING INFORMATION

See detailed ordering, marking and shipping information on page 6 of this data sheet.

# NC7NP34

## MAXIMUM RATINGS

Symbol	Characteristics	Value	Unit
V <sub>CC</sub>	DC Supply Voltage	-0.5 to +4.3	V
V <sub>IN</sub>	DC Input Voltage	-0.5 to +4.3	V
V <sub>OUT</sub>	DC Output Voltage Active-Mode (High or Low State) Tri-State Mode (Note 1) Power-Down Mode (V <sub>CC</sub> = 0 V)	-0.5 to V <sub>CC</sub> + 0.5 -0.5 to +4.3 -0.5 to +4.3	V
I <sub>IK</sub>	DC Input Diode Current V <sub>IN</sub> < GND	-50	mA
I <sub>OK</sub>	DC Output Diode Current V <sub>OUT</sub> < GND	-50	mA
I <sub>OUT</sub>	DC Output Source/Sink Current	±50	mA
I <sub>CC</sub> or I <sub>GND</sub>	DC Supply Current per Supply Pin or Ground Pin	±50	mA
T <sub>STG</sub>	Storage Temperature Range	-65 to +150	°C
T <sub>L</sub>	Lead Temperature, 1 mm from Case for 10 Seconds	260	°C
T <sub>J</sub>	Junction Temperature Under Bias	+150	°C
θ <sub>JA</sub>	Thermal Resistance (Note 2) US8 MicroPak	250 210	°C/W
P <sub>D</sub>	Power Dissipation in Still Air US8 MicroPak	500 595	mW
MSL	Moisture Sensitivity	Level 1	-
F <sub>R</sub>	Flammability Rating Oxygen Index: 28 to 34	UL 94 V-0 @ 0.125 in	-
V <sub>ESD</sub>	ESD Withstand Voltage (Note 3) Human Body Model Charged Device Model	2000 1000	V
I <sub>Latchup</sub>	Latchup Performance (Note 4)	±100	mA

Stresses exceeding those listed in the Maximum Ratings table may damage the device. If any of these limits are exceeded, device functionality should not be assumed, damage may occur and reliability may be affected.

1. Applicable to devices with outputs that may be tri-stated.
2. Measured with minimum pad spacing on an FR4 board, using 10 mm-by-1 inch, 2 ounce copper trace no air flow per JESD51-7.
3. HBM tested to EIA / JESD22-A114-A. CDM tested to JESD22-C101-A. JEDEC recommends that ESD qualification to EIA/JESD22-A115A (Machine Model) be discontinued.
4. Tested to EIA/JESD78 Class II.

## RECOMMENDED OPERATING CONDITIONS

Symbol	Parameter	Min	Max	Unit
V <sub>CC</sub>	Positive DC Supply Voltage	0.9	3.6	V
V <sub>IN</sub>	DC Input Voltage	0	3.6	V
V <sub>OUT</sub>	DC Output Voltage Active-Mode (High or Low State) Tri-State Mode (Note 1) Power-Down Mode (V <sub>CC</sub> = 0 V)	0 0 0	V <sub>CC</sub> 3.6 3.6	V
T <sub>A</sub>	Operating Temperature Range	-40	+85	°C
t <sub>r</sub> , t <sub>f</sub>	Input Transition Rise and Fall Time V <sub>CC</sub> = 3.3 V ± 0.3 V	0	10	ns/V

Functional operation above the stresses listed in the Recommended Operating Ranges is not implied. Extended exposure to stresses beyond the Recommended Operating Ranges limits may affect device reliability.

# NC7NP34

## DC ELECTRICAL CHARACTERISTICS

Symbol	Parameter	Condition	V <sub>CC</sub> (V)	T <sub>A</sub> = 25°C			T <sub>A</sub> = -40°C to +85°C		Unit
				Min	Typ	Max	Min	Max	
V <sub>IH</sub>	High-Level Input Voltage		0.9	-	0.5	-	-	-	V
			1.1 to 1.3	0.65 x V <sub>CC</sub>	-	-	0.65 x V <sub>CC</sub>	-	
			1.4 to 1.6	0.65 x V <sub>CC</sub>	-	-	0.65 x V <sub>CC</sub>	-	
			1.65 to 1.95	0.65 x V <sub>CC</sub>	-	-	0.65 x V <sub>CC</sub>	-	
			2.3 to 2.7	1.6	-	-	1.6	-	
3.0 to 3.6	2.1	-	-	2.1	-				
V <sub>IL</sub>	Low-Level Input Voltage		0.9	-	0.5	-	-	-	V
			1.1 to 1.3	-	-	0.35 x V <sub>CC</sub>	-	0.35 x V <sub>CC</sub>	
			1.4 to 1.6	-	-	0.35 x V <sub>CC</sub>	-	0.35 x V <sub>CC</sub>	
			1.65 to 1.95	-	-	0.35 x V <sub>CC</sub>	-	0.35 x V <sub>CC</sub>	
			2.3 to 2.7	-	-	0.7	-	0.7	
3.0 to 3.6	-	-	0.9	-	0.9				
V <sub>OH</sub>	High-Level Output Voltage	V <sub>IN</sub> = V <sub>IH</sub> or V <sub>IL</sub>							V
		I <sub>OH</sub> = -20 μA	0.9	-	V <sub>CC</sub> - 0.1	-	-	-	
			1.1 to 1.3	V <sub>CC</sub> - 0.1	-	-	V <sub>CC</sub> - 0.1	-	
			1.4 to 1.6	V <sub>CC</sub> - 0.1	-	-	V <sub>CC</sub> - 0.1	-	
			1.65 to 1.95	V <sub>CC</sub> - 0.1	-	-	V <sub>CC</sub> - 0.1	-	
			2.3 to 2.7	V <sub>CC</sub> - 0.1	-	-	V <sub>CC</sub> - 0.1	-	
			3.0 to 3.6	V <sub>CC</sub> - 0.1	-	-	V <sub>CC</sub> - 0.1	-	
		I <sub>OH</sub> = -0.5 mA	1.1 to 1.3	0.75 x V <sub>CC</sub>	-	-	0.70 x V <sub>CC</sub>	-	
		I <sub>OH</sub> = -1 mA	1.4 to 1.6	1.07	-	-	0.99	-	
		I <sub>OH</sub> = -1.5 mA	1.65 to 1.95	1.24	-	-	1.22	-	
I <sub>OH</sub> = -2.1 mA	2.3 to 2.7	1.95	-	-	1.87	-			
I <sub>OH</sub> = -2.6 mA	3.0 to 3.6	2.61	-	-	2.55	-			
V <sub>OL</sub>	Low-Level Output Voltage	V <sub>IN</sub> = V <sub>IH</sub> or V <sub>IL</sub>							V
		I <sub>OL</sub> = 20 μA	0.9	-	0.1	-	-	-	
			1.1 to 1.3	-	-	0.1	-	0.1	
			1.4 to 1.6	-	-	0.1	-	0.1	
			1.65 to 1.95	-	-	0.1	-	0.1	
			2.3 to 2.7	-	-	0.1	-	0.1	
			3.0 to 3.6	-	-	0.1	-	0.1	
		I <sub>OL</sub> = 0.5 mA	1.1 to 1.3	-	-	0.3 x V <sub>CC</sub>	-	0.3 x V <sub>CC</sub>	
		I <sub>OL</sub> = 1 mA	1.4 to 1.6	-	-	0.31	-	0.37	
		I <sub>OL</sub> = 1.5 mA	1.65 to 1.95	-	-	0.31	-	0.35	
I <sub>OL</sub> = 2.1 mA	2.3 to 2.7	-	-	0.31	-	0.33			
I <sub>OL</sub> = 2.6 mA	3.0 to 3.6	-	-	0.31	-	0.33			
I <sub>IN</sub>	Input Leakage Current	V <sub>IN</sub> = 0 V to 3.6 V	0.9 to 3.6	-	-	±0.1	-	±0.5	μA
I <sub>OFF</sub>	Power Off Leakage Current	V <sub>IN</sub> = 0 V to 3.6 V or V <sub>OUT</sub> = 0 V to 3.6 V	0	-	-	0.5	-	0.5	μA
I <sub>CC</sub>	Quiescent Supply Current	V <sub>IN</sub> = V <sub>CC</sub> or GND	0.9 to 3.6	-	-	0.9	-	0.9	μA

Product parametric performance is indicated in the Electrical Characteristics for the listed test conditions, unless otherwise noted. Product performance may not be indicated by the Electrical Characteristics if operated under different conditions.

# NC7NP34

## AC ELECTRICAL CHARACTERISTICS

Symbol	Parameter	Condition	V <sub>CC</sub> (V)	T <sub>A</sub> = 25°C			T <sub>A</sub> = -40°C to +85°C		Unit
				Min	Typ	Max	Min	Max	
t <sub>PLH</sub> , t <sub>PHL</sub>	Propagation Delay, A to Y (Figures 3 and 4)	R <sub>L</sub> = 1 MΩ, C <sub>L</sub> = 10 pF	0.9	-	45.0	-	-	-	ns
			1.10 to 1.30	-	11.9	25.9	-	34.3	
			1.40 to 1.60	-	6.2	14.8	-	15.0	
			1.65 to 1.95	-	4.4	12.0	-	12.2	
			2.3 to 2.7	-	3.3	9.4	-	9.9	
			3.0 to 3.6	-	2.7	8.3	-	9.0	
t <sub>PLH</sub> , t <sub>PHL</sub>	Propagation Delay, A to Y (Figures 3 and 4)	R <sub>L</sub> = 1 MΩ, C <sub>L</sub> = 15 pF	0.9	-	46.6	-	-	-	ns
			1.10 to 1.30	-	12.5	27.3	-	37.3	
			1.40 to 1.60	-	6.7	15.5	-	16.5	
			1.65 to 1.95	-	4.8	12.6	-	13.6	
			2.3 to 2.7	-	3.5	9.9	-	10.8	
			3.0 to 3.6	-	2.9	8.7	-	9.5	
t <sub>PLH</sub> , t <sub>PHL</sub>	Propagation Delay, A to Y (Figures 3 and 4)	R <sub>L</sub> = 1 MΩ, C <sub>L</sub> = 30 pF	0.9	-	51.3	-	-	-	ns
			1.10 to 1.30	-	14.5	31.6	-	46.3	
			1.40 to 1.60	-	8.2	17.8	-	18.2	
			1.65 to 1.95	-	5.9	14.4	-	15.9	
			2.3 to 2.7	-	4.2	11.3	-	12.8	
			3.0 to 3.6	-	3.4	9.2	-	10.7	

## CAPACITIVE CHARACTERISTICS

Symbol	Parameter	Test Condition	Typical (T <sub>A</sub> = 25°C)	Unit
C <sub>IN</sub>	Input Capacitance	V <sub>CC</sub> = 0 V	2.0	pF
C <sub>OUT</sub>	Output Capacitance	V <sub>CC</sub> = 0 V	4.0	pF
C <sub>PD</sub>	Power Dissipation Capacitance (Note 5)	f = 10 MHz, V <sub>CC</sub> = 0.9 to 3.6 V, V <sub>IN</sub> = 0 V or V <sub>CC</sub>	6.0	pF

5. C<sub>PD</sub> is defined as the value of the internal equivalent capacitance which is calculated from the operating current consumption without load. Average operating current can be obtained by the equation I<sub>CC(OPR)</sub> = C<sub>PD</sub> • V<sub>CC</sub> • f<sub>in</sub> + I<sub>CC</sub>. C<sub>PD</sub> is used to determine the no-load dynamic power consumption: P<sub>D</sub> = C<sub>PD</sub> • V<sub>CC</sub><sup>2</sup> • f<sub>in</sub> + I<sub>CC</sub> • V<sub>CC</sub>.

# NC7NP34

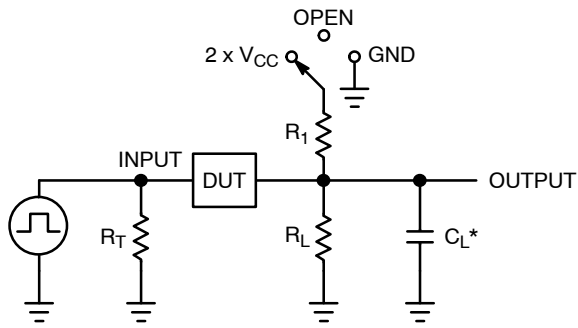

$C_L$  includes probe and jig capacitance  
 $R_T$  is  $Z_{OUT}$  of pulse generator (typically 50  $\Omega$ )  
 $f = 1$  MHz

Test	Switch Position
$t_{PLH} / t_{PHL}$	Open
$t_{PLZ} / t_{PZL}$	$2 \times V_{CC}$
$t_{PHZ} / t_{PZH}$	GND

Figure 3. Test Circuit



$V_{CC}, V$	$V_{mi}, V$	$V_{mo}, V$	$V_Y, V$
0.9	$V_{CC} / 2$	$V_{CC} / 2$	0.1
1.1 to 1.3	$V_{CC} / 2$	$V_{CC} / 2$	0.1
1.4 to 1.6	$V_{CC} / 2$	$V_{CC} / 2$	0.1
1.65 to 1.95	$V_{CC} / 2$	$V_{CC} / 2$	0.15
2.3 to 2.7	$V_{CC} / 2$	$V_{CC} / 2$	0.15
3.0 to 3.6	1.5	1.5	0.3

Figure 4. Switching Waveforms

# NC7NP34

## ORDERING INFORMATION

Device	Package	Marking	Pin 1 Orientation (See below)	Shipping <sup>†</sup>
NC7NP34K8X	US8	NP34	Q4	3000 / Tape & Reel
NC7NP34L8X	MicroPak, UQFN8	X7	Q4	5000 / Tape & Reel

<sup>†</sup>For information on tape and reel specifications, including part orientation and tape sizes, please refer to our Tape and Reel Packaging Specifications Brochure, BRD8011/D.

### Pin 1 Orientation in Tape and Reel

Direction of Feed

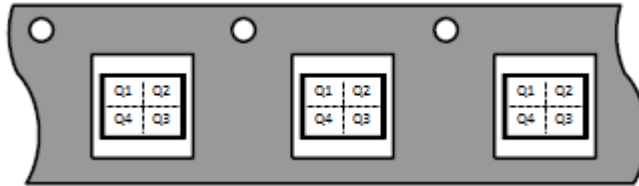

MicroPak is trademark of Semiconductor Components Industries, LLC (SCILLC) or its subsidiaries in the United States and/or other countries.



**UQFN8 1.6X1.6, 0.5P**  
CASE 523AY  
ISSUE O

DATE 31 AUG 2016



**RECOMMENDED  
LAND PATTERN**

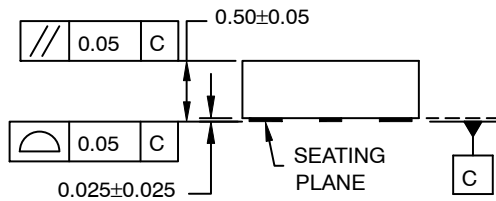

**SIDE VIEW**

**NOTES:**

- A. PACKAGE CONFORMS TO JEDEC MO-255 VARIATION UAAD.
- B. DIMENSIONS ARE IN MILLIMETERS.
- C. DIMENSIONS AND TOLERANCES PER ASME Y14.5M, 2009.
- D. LAND PATTERN RECOMMENDATION IS EXISTING INDUSTRY LAND PATTERN.



**BOTTOM VIEW**

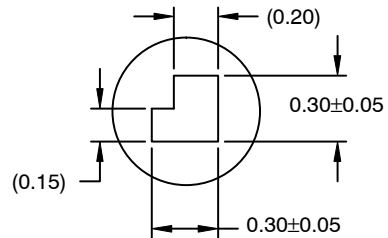

**DETAIL A  
SCALE : 2X**

<b>DOCUMENT NUMBER:</b>	<b>98AON13591G</b>	Electronic versions are uncontrolled except when accessed directly from the Document Repository. Printed versions are uncontrolled except when stamped "CONTROLLED COPY" in red.
<b>DESCRIPTION:</b>	<b>UQFN8 1.6X1.6, 0.5P</b>	<b>PAGE 1 OF 1</b>

ON Semiconductor and are trademarks of Semiconductor Components Industries, LLC dba ON Semiconductor or its subsidiaries in the United States and/or other countries. ON Semiconductor reserves the right to make changes without further notice to any products herein. ON Semiconductor makes no warranty, representation or guarantee regarding the suitability of its products for any particular purpose, nor does ON Semiconductor assume any liability arising out of the application or use of any product or circuit, and specifically disclaims any and all liability, including without limitation special, consequential or incidental damages. ON Semiconductor does not convey any license under its patent rights nor the rights of others.



US8  
CASE 846AN  
ISSUE O

DATE 31 DEC 2016



**NOTES:**

- A. CONFORMS TO JEDEC REGISTRATION MO-187
- B. DIMENSIONS ARE IN MILLIMETERS.
- C. DIMENSIONS ARE EXCLUSIVE OF BURRS, MOLD FLASH, AND TIE BAR EXTRUSIONS.
- D. DIMENSIONS AND TOLERANCES PER ANSI Y14.5M, 1994.



<b>DOCUMENT NUMBER:</b>	<b>98AON13778G</b>	Electronic versions are uncontrolled except when accessed directly from the Document Repository. Printed versions are uncontrolled except when stamped "CONTROLLED COPY" in red.
<b>DESCRIPTION:</b>	<b>US8</b>	<b>PAGE 1 OF 1</b>

ON Semiconductor and are trademarks of Semiconductor Components Industries, LLC dba ON Semiconductor or its subsidiaries in the United States and/or other countries. ON Semiconductor reserves the right to make changes without further notice to any products herein. ON Semiconductor makes no warranty, representation or guarantee regarding the suitability of its products for any particular purpose, nor does ON Semiconductor assume any liability arising out of the application or use of any product or circuit, and specifically disclaims any and all liability, including without limitation special, consequential or incidental damages. ON Semiconductor does not convey any license under its patent rights nor the rights of others.



**onsemi**, **Onsemi**, and other names, marks, and brands are registered and/or common law trademarks of Semiconductor Components Industries, LLC dba "**onsemi**" or its affiliates and/or subsidiaries in the United States and/or other countries. **onsemi** owns the rights to a number of patents, trademarks, copyrights, trade secrets, and other intellectual property. A listing of **onsemi**'s product/patent coverage may be accessed at [www.onsemi.com/site/pdf/Patent-Marking.pdf](http://www.onsemi.com/site/pdf/Patent-Marking.pdf). **onsemi** reserves the right to make changes at any time to any products or information herein, without notice. The information herein is provided "as-is" and **onsemi** makes no warranty, representation or guarantee regarding the accuracy of the information, product features, availability, functionality, or suitability of its products for any particular purpose, nor does **onsemi** assume any liability arising out of the application or use of any product or circuit, and specifically disclaims any and all liability, including without limitation special, consequential or incidental damages. Buyer is responsible for its products and applications using **onsemi** products, including compliance with all laws, regulations and safety requirements or standards, regardless of any support or applications information provided by **onsemi**. "Typical" parameters which may be provided in **onsemi** data sheets and/or specifications can and do vary in different applications and actual performance may vary over time. All operating parameters, including "Typicals" must be validated for each customer application by customer's technical experts. **onsemi** does not convey any license under any of its intellectual property rights nor the rights of others. **onsemi** products are not designed, intended, or authorized for use as a critical component in life support systems or any FDA Class 3 medical devices or medical devices with a same or similar classification in a foreign jurisdiction or any devices intended for implantation in the human body. Should Buyer purchase or use **onsemi** products for any such unintended or unauthorized application, Buyer shall indemnify and hold **onsemi** and its officers, employees, subsidiaries, affiliates, and distributors harmless against all claims, costs, damages, and expenses, and reasonable attorney fees arising out of, directly or indirectly, any claim of personal injury or death associated with such unintended or unauthorized use, even if such claim alleges that **onsemi** was negligent regarding the design or manufacture of the part. **onsemi** is an Equal Opportunity/Affirmative Action Employer. This literature is subject to all applicable copyright laws and is not for resale in any manner.

## PUBLICATION ORDERING INFORMATION

### LITERATURE FULFILLMENT:

Email Requests to: [orderlit@onsemi.com](mailto:orderlit@onsemi.com)

**onsemi Website:** [www.onsemi.com](http://www.onsemi.com)

### TECHNICAL SUPPORT

**North American Technical Support:**

Voice Mail: 1 800-282-9855 Toll Free USA/Canada

Phone: 011 421 33 790 2910

**Europe, Middle East and Africa Technical Support:**

Phone: 00421 33 790 2910

For additional information, please contact your local Sales Representative