

Ultra Low Power, Rail-to-Rail Output, Fully-Differential Amplifier

1 Features

- Ultra Low Power:
 - Voltage: 2.5 V to 5.5 V
 - Current: 250 μ A
 - Power-Down Mode: 0.5 μ A (typical)
- Fully-Differential Architecture
- Bandwidth: 36 MHz
- Slew Rate: 200 V/ μ s
- THD: -120 dBc at 1 kHz ($1 V_{RMS}$, $R_L = 2$ k Ω)
- Input Voltage Noise: 10 nV/ $\sqrt{\text{Hz}}$ ($f = 1$ kHz)
- High DC Accuracy:
 - V_{OS} Drift: ± 4 μ V/ $^{\circ}$ C (-40° C to $+125^{\circ}$ C)
 - A_{OL} : 114 dB
- Rail-to-Rail Output (RRO)
- Negative Rail Input (NRI)
- Output Common-Mode Control

2 Applications

- Low-Power SAR, $\Delta\Sigma$ ADC Driver
- Low Power, High Performance:
 - Differential to Differential Amplifier
 - Single-Ended to Differential Amplifier
- Low-Power, Wide-Bandwidth Differential Driver
- Low-Power, Wide-Bandwidth Differential Signal Conditioning
- High Channel Count and Power Dense Systems

Figure 1. 1 kHz FFT Plot on Audio Analyzer

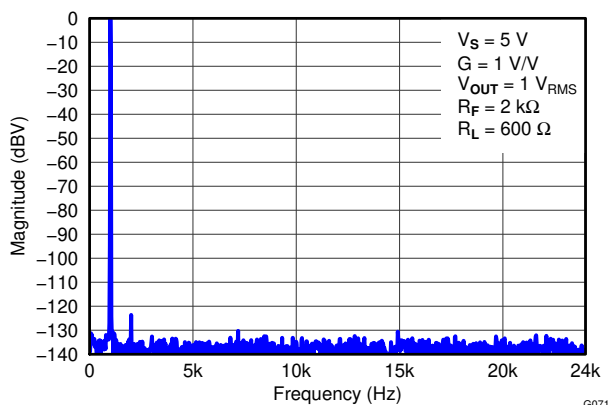

3 Description

The THS4531 is a low-power, fully-differential op amp with input common-mode range below the negative rail and rail-to-rail output. The device is designed for low-power data acquisition systems and high density applications where power consumption and dissipation is critical.

The device features accurate output common-mode control that allows for dc coupling when driving analog-to-digital converters (ADCs). This control, coupled with the input common-mode range below the negative rail and rail-to-rail output, allows for easy interface from single-ended ground-referenced signal sources to successive-approximation registers (SARs), and delta-sigma ($\Delta\Sigma$) ADCs using only single-supply 2.5 V to 5 V power. The THS4531 is also a valuable tool for general-purpose, low-power differential signal conditioning applications.

The THS4531 is characterized for operation over the extended industrial temperature range from -40° C to $+125^{\circ}$ C. The following package options are available:

Device Information⁽¹⁾

DEVICE NUMBER	PACKAGE	BODY SIZE (NOM)
THS4531	SOIC (8)	4.90 mm x 3.91 mm
	VSSOP (8)	3.00 mm x 3.00 mm
	WQFN (10)	2.00 mm x 2.00 mm

(1) For all available packages, see the orderable addendum at the end of the data sheet.

Table 1. Device Comparison

DEVICE	BW (MHz)	I_Q (mA)	THD (dBc) at 100 kHz	$V_{N_{1kHz}}$ (nV/ $\sqrt{\text{Hz}}$)	RAIL-TO-RAIL
THS4521	145	1.14	-120	4.6	$-$ In/Out
THS4121	100	16	-79	5.4	In/Out
THS4131	150	16	-107	1.3	No
THS4561	60	0.78	-116	4	$-$ In/Out
THS4551	150	1.37	-128	3.3	$-$ In/Out
THS4541	850	10.1	-137	2.2	$-$ In/Out



Table of Contents

1 Features	1	9.1 Typical Characteristics Test Circuits.....	25
2 Applications	1	9.2 Application Circuits.....	30
3 Description	1	9.3 Audio ADC Driver Performance: THS4531 AND PCM4204 Combined Performance	36
4 Revision History	2	9.4 SAR ADC Performance	38
5 Electrical Specifications	4	9.5 EVM and Layout Recommendations	41
5.1 Absolute Maximum Ratings	4	10 Device and Documentation Support	42
5.2 Thermal Information	4	10.1 Device Support.....	42
5.3 Electrical Characteristics: $V_S = 2.7\text{ V}$	5	10.2 Documentation Support	42
5.4 Electrical Characteristics: $V_S = 5\text{ V}$	8	10.3 Community Resources.....	42
6 Device Information	11	10.4 Trademarks	42
6.1 PIN Configurations	11	10.5 Electrostatic Discharge Caution.....	42
6.2 Table of Graphs	12	10.6 Glossary	42
7 Typical Characteristics: $V_S = 2.7\text{ V}$	13	11 Mechanical, Packaging, and Orderable Information	42
8 Typical Characteristics: $V_S = 5\text{ V}$	19		
9 Application Information	25		

4 Revision History

NOTE: Page numbers for previous revisions may differ from page numbers in the current version.

Changes from Revision B (March 2012) to Revision C Page

- Changed the continuous input current , I_i value in the Absolute Maximum Ratings section From: *7.5-mA* To: *10-mA*..... **4**

Changes from Revision A (January 2012) to Revision B Page

- Deleted DC Performance, *Input-referred offset voltage* parameter typical specifications for $T_A = 0^\circ\text{C}$ to $+70^\circ\text{C}$, -40°C to $+85^\circ\text{C}$, and -40°C to $+125^\circ\text{C}$ in 2.7 V Electrical Characteristics table
- Changed DC Performance, *Input-referred offset voltage* parameter maximum specifications for $T_A = 0^\circ\text{C}$ to $+70^\circ\text{C}$, -40°C to $+85^\circ\text{C}$, and -40°C to $+125^\circ\text{C}$ in 2.7 V Electrical Characteristics table
- Changed DC Performance, *Input offset voltage drift* parameter typical and maximum specifications in 2.7 V Electrical Characteristics table
- Deleted DC Performance, *Input bias current* parameter typical specifications for $T_A = 0^\circ\text{C}$ to $+70^\circ\text{C}$, -40°C to $+85^\circ\text{C}$, and -40°C to $+125^\circ\text{C}$ in 2.7 V Electrical Characteristics table
- Deleted DC Performance, *Input bias current drift* parameter typical specifications in 2.7 V Electrical Characteristics table
- Deleted DC Performance, *Input offset current* parameter typical specifications for $T_A = 0^\circ\text{C}$ to $+70^\circ\text{C}$, -40°C to $+85^\circ\text{C}$, and -40°C to $+125^\circ\text{C}$ in 2.7 V Electrical Characteristics table
- Deleted DC Performance, *Input-referred offset voltage* parameter typical specifications for $T_A = 0^\circ\text{C}$ to $+70^\circ\text{C}$, -40°C to $+85^\circ\text{C}$, and -40°C to $+125^\circ\text{C}$ in 5 V Electrical Characteristics table
- Changed DC Performance, *Input-referred offset voltage* parameter maximum specifications for $T_A = 0^\circ\text{C}$ to $+70^\circ\text{C}$, -40°C to $+85^\circ\text{C}$, and -40°C to $+125^\circ\text{C}$ in 5 V Electrical Characteristics table
- Changed DC Performance, *Input offset voltage drift* parameter typical specifications in 5 V Electrical Characteristics table
- Deleted DC Performance, *Input bias current* parameter typical specifications for $T_A = 0^\circ\text{C}$ to $+70^\circ\text{C}$, -40°C to $+85^\circ\text{C}$, and -40°C to $+125^\circ\text{C}$ in 5 V Electrical Characteristics table.....
- Deleted DC Performance, *Input offset current* parameter typical specifications for $T_A = 0^\circ\text{C}$ to $+70^\circ\text{C}$, -40°C to $+85^\circ\text{C}$, and -40°C to $+125^\circ\text{C}$ in 5 V Electrical Characteristics table

Changes from Original (September 2011) to Revision A**Page**

-
- Changed status from product preview to production data..... 1
-

Table 2. Packaging and Ordering Information⁽¹⁾

PRODUCT	CHANNEL COUNT	PACKAGE-LEAD	PACKAGE DESIGNATOR	SPECIFIED TEMPERATURE RANGE	PACKAGE MARKING	ORDERING NUMBER	TRANSPORT MEDIA, QUANTITY
THS4531	1	SOIC-8	D	-40°C to +125°C	T4531	THS4531ID	Rails, 75
	1				T4531	THS4531IDR	Tape and reel, 2500
	1	VSSOP-8	DGK	-40°C to +125°C	4531	THS4531IDGK	Rails, 80
	1				4531	THS4531IDGKR	Tape and reel, 2500
	1	WQFN-10	RUN	-40°C to +125°C	4531	THS4531IRUNT	Tape and reel, 250
	1				4531	THS4531IRUNR	Tape and reel, 3000

(1) For the most current package and ordering information, see the Package Option Addendum at the end of this document, or see the TI web site at www.ti.com.

5 Electrical Specifications

5.1 Absolute Maximum Ratings

	VALUE	UNITS	
Supply voltage, V_{S-} to V_{S+}	5.5		
Input/output voltage, $V_{IN\pm}$, $V_{OUT\pm}$, and V_{OCM} pins	$(V_{S-}) - 0.7$ to $(V_{S+}) + 0.7$	V	
Differential input voltage, V_{ID}	1	V	
Continuous output current, I_O	50	mA	
Continuous input current, I_i	10	mA	
Continuous power dissipation	See Thermal Information		
Maximum junction temperature, T_J	150	°C	
Operating free-air temperature range, T_A	-40 to +125	°C	
Storage temperature range, T_{stg}	-65 to +150	°C	
Electrostatic discharge (ESD) ratings:	Human body model (HBM)	3000	V
	Charge device model (CDM)	500	V
	Machine model (MM)	200	V

5.2 Thermal Information

THERMAL METRIC ⁽¹⁾		THS4531	THS4531	THS4531	UNITS
		SOIC (P)	VSSOP (MSOP) (DGK)	WQFN (RUN)	
		8 PINS	8 PINS	10 PINS	
θ_{JA}	Junction-to-ambient thermal resistance	133	198	163	°C/W
θ_{JcTop}	Junction-to-case (top) thermal resistance	78	84	66	
θ_{JB}	Junction-to-board thermal resistance	73	120	113	
Ψ_{JT}	Junction-to-top characterization parameter	26	19	17	
Ψ_{JB}	Junction-to-board characterization parameter	73	118	113	
θ_{JcBot}	Junction-to-case (bottom) thermal resistance	N/A	N/A	N/A	

(1) For more information about traditional and new thermal metrics, see the *Semiconductor and IC Package Thermal Metrics* application report (SPRA953).

5.3 Electrical Characteristics: $V_S = 2.7\text{ V}$

Test conditions at $T_A = 25^\circ\text{C}$, $V_{S+} = 2.7\text{ V}$, $V_{S-} = 0\text{ V}$, $V_{OCM} = \text{open}$, $V_{OUT} = 2\text{ V}_{PP}$, $R_F = 2\text{ k}\Omega$, $R_L = 2\text{ k}\Omega$ differential, $G = 1\text{ V/V}$, single-ended input, differential output, and input and output referenced to mid-supply, unless otherwise noted.

PARAMETER	CONDITIONS	MIN	TYP	MAX	UNITS	TEST LEVEL ⁽¹⁾
AC PERFORMANCE						
Small-signal bandwidth	$V_{OUT} = 100\text{ mV}_{PP}$, $G = 1$		34		MHz	C
	$V_{OUT} = 100\text{ mV}_{PP}$, $G = 2$		16			
	$V_{OUT} = 100\text{ mV}_{PP}$, $G = 5$		6			
	$V_{OUT} = 100\text{ mV}_{PP}$, $G = 10$		2.7			
Gain-bandwidth product	$V_{OUT} = 100\text{ mV}_{PP}$, $G = 10$		27		MHz	
Large-signal bandwidth	$V_{OUT} = 2\text{ V}_{PP}$, $G = 1$		34		MHz	
Bandwidth for 0.1-dB flatness	$V_{OUT} = 2\text{ V}_{PP}$, $G = 1$		12		MHz	
Slew rate, rise/fall, 25% to 75%	$V_{OUT} = 2\text{ V}$ step		190/320		V/ μs	
Rise/fall time, 10% to 90%			5.2/6.1		ns	
Settling time to 1%, rise and fall			25/20		ns	
Settling time to 0.1%, rise and fall			60/60		ns	
Settling time to 0.01%, rise and fall			150/110		ns	
Overshoot/undershoot, rise and fall				1/1		
2nd-order harmonic distortion	$f = 1\text{ kHz}$, $V_{OUT} = 1\text{ V}_{RMS}$		-122		dBc	
	$f = 10\text{ kHz}$		-127			
	$f = 1\text{ MHz}$		-59			
3rd-order harmonic distortion	$f = 1\text{ kHz}$, $V_{OUT} = 1\text{ V}_{RMS}$		-130		dBc	
	$f = 10\text{ kHz}$		-135			
	$f = 1\text{ MHz}$		-70			
2nd-order intermodulation distortion	$f = 1\text{ MHz}$, 200 Hz tone spacing, V_{OUT} envelope = 1 V_{PP}		-83		dBc	
3rd-order intermodulation distortion			-81			
Input voltage noise	$f = 1\text{ kHz}$		10		nV/ $\sqrt{\text{Hz}}$	
Voltage noise 1/f corner frequency			45		Hz	
Input current noise	$f = 100\text{ kHz}$		0.25		pA/ $\sqrt{\text{Hz}}$	
Current noise 1/f corner frequency			6.5		kHz	
Overdrive recovery time	Overdrive = 0.5 V		65		ns	
Output balance error	$V_{OUT} = 100\text{ mV}$, $f = 1\text{ MHz}$		-65		dB	
Closed-loop output impedance	$f = 1\text{ MHz}$ (differential)		2.5		Ω	

(1) Test levels (all values set by characterization and simulation): (A) 100% tested at $+25^\circ\text{C}$; over temperature limits by characterization and simulation. (B) Not tested in production; limits set by characterization and simulation. (C) Typical value only for information.

Electrical Characteristics: $V_S = 2.7\text{ V}$ (continued)

Test conditions at $T_A = 25^\circ\text{C}$, $V_{S+} = 2.7\text{ V}$, $V_{S-} = 0\text{ V}$, $V_{OCM} = \text{open}$, $V_{OUT} = 2 V_{PP}$, $R_F = 2\text{ k}\Omega$, $R_L = 2\text{ k}\Omega$ differential, $G = 1\text{ V/V}$, single-ended input, differential output, and input and output referenced to mid-supply, unless otherwise noted.

PARAMETER	CONDITIONS	MIN	TYP	MAX	UNITS	TEST LEVEL ⁽¹⁾
DC PERFORMANCE						
Open-loop voltage gain (A_{OL})		100	113		dB	A
Input-referred offset voltage	$T_A = +25^\circ\text{C}$		± 200	± 1000	μV	A
	$T_A = 0^\circ\text{C}$ to $+70^\circ\text{C}$			± 1405		B
	$T_A = -40^\circ\text{C}$ to $+85^\circ\text{C}$			± 1585		
	$T_A = -40^\circ\text{C}$ to $+125^\circ\text{C}$			± 2000		
Input offset voltage drift ⁽²⁾	$T_A = 0^\circ\text{C}$ to $+70^\circ\text{C}$		± 1.7	± 9	$\mu\text{V}/^\circ\text{C}$	B
	$T_A = -40^\circ\text{C}$ to $+85^\circ\text{C}$		± 1.8	± 9		
	$T_A = -40^\circ\text{C}$ to $+125^\circ\text{C}$		± 2	± 10		
Input bias current	$T_A = +25^\circ\text{C}$		160	210	nA	A
	$T_A = 0^\circ\text{C}$ to $+70^\circ\text{C}$			221		B
	$T_A = -40^\circ\text{C}$ to $+85^\circ\text{C}$			222		
	$T_A = -40^\circ\text{C}$ to $+125^\circ\text{C}$			233		
Input bias current drift ⁽²⁾	$T_A = 0^\circ\text{C}$ to $+70^\circ\text{C}$			0.25	nA/ $^\circ\text{C}$	B
	$T_A = -40^\circ\text{C}$ to $+85^\circ\text{C}$			0.25		
	$T_A = -40^\circ\text{C}$ to $+125^\circ\text{C}$			0.25		
Input offset current	$T_A = +25^\circ\text{C}$		± 5	± 50	nA	A
	$T_A = 0^\circ\text{C}$ to $+70^\circ\text{C}$			± 59		B
	$T_A = -40^\circ\text{C}$ to $+85^\circ\text{C}$			± 60		
	$T_A = -40^\circ\text{C}$ to $+125^\circ\text{C}$			± 75		
Input offset current drift ⁽²⁾	$T_A = 0^\circ\text{C}$ to $+70^\circ\text{C}$		± 0.05	± 0.2	nA/ $^\circ\text{C}$	B
	$T_A = -40^\circ\text{C}$ to $+85^\circ\text{C}$		± 0.05	± 0.2		
	$T_A = -40^\circ\text{C}$ to $+125^\circ\text{C}$		± 0.05	± 0.2		
INPUT						
Common-mode input low	$T_A = +25^\circ\text{C}$, CMRR > 87 dB		$V_{S-} - 0.2$	V_{S-}	V	A
	$T_A = -40^\circ\text{C}$ to $+125^\circ\text{C}$, CMRR > 87 dB		$V_{S-} - 0.2$	V_{S-}		B
Common-mode input high	$T_A = +25^\circ\text{C}$, CMRR > 87 dB	$V_{S+} - 1.2$	$V_{S+} - 1.1$		V	A
	$T_A = -40^\circ\text{C}$ to $+125^\circ\text{C}$, CMRR > 87 dB	$V_{S+} - 1.2$	$V_{S+} - 1.1$			B
Common-mode rejection ratio		90	116		dB	A
Input impedance common-mode			$200 \parallel 1.2$		k Ω pF	C
Input impedance differential mode			$200 \parallel 1$			C
OUTPUT						
Single-ended output voltage: low	$T_A = +25^\circ\text{C}$		$V_{S-} + 0.06$	$V_{S-} + 0.2$	V	A
	$T_A = -40^\circ\text{C}$ to $+125^\circ\text{C}$		$V_{S-} + 0.06$	$V_{S-} + 0.2$		B
Single-ended output voltage: high	$T_A = +25^\circ\text{C}$	$V_{S+} - 0.2$	$V_{S+} - 0.11$		V	A
	$T_A = -40^\circ\text{C}$ to $+125^\circ\text{C}$	$V_{S+} - 0.2$	$V_{S+} - 0.11$			B
Output saturation voltage: high and low			110/60		mV	C
Linear output current drive	$T_A = +25^\circ\text{C}$	± 15	± 22		mA	A
	$T_A = -40^\circ\text{C}$ to $+125^\circ\text{C}$	± 15				B

(2) Input offset voltage drift, input bias current drift, and input offset current drift are average values calculated by taking data at the end points, computing the difference, and dividing by the temperature range.

Electrical Characteristics: $V_S = 2.7\text{ V}$ (continued)

Test conditions at $T_A = 25^\circ\text{C}$, $V_{S+} = 2.7\text{ V}$, $V_{S-} = 0\text{ V}$, $V_{OCM} = \text{open}$, $V_{OUT} = 2\text{ V}_{PP}$, $R_F = 2\text{ k}\Omega$, $R_L = 2\text{ k}\Omega$ differential, $G = 1\text{ V/V}$, single-ended input, differential output, and input and output referenced to mid-supply, unless otherwise noted.

PARAMETER	CONDITIONS	MIN	TYP	MAX	UNITS	TEST LEVEL ⁽¹⁾
POWER SUPPLY						
Specified operating voltage		2.5		5.5	V	B
Quiescent operating current/ch	$T_A = +25^\circ\text{C}$, $\overline{PD} = V_{S+}$		230	330	μA	A
	$T_A = -40^\circ\text{C}$ to $+125^\circ\text{C}$, $\overline{PD} = V_{S+}$		270	370		B
Power-supply rejection ($\pm\text{PSRR}$)		87	108		dB	A
POWER DOWN						
Enable voltage threshold	Specified on above 2.1 V			2.1	V	A
Disable voltage threshold	Specified off below 0.7 V	0.7				A
Disable pin bias current	$\overline{PD} = V_{S-} + 0.5\text{ V}$		50	500	nA	A
Power-down quiescent current	$\overline{PD} = V_{S-} + 0.5\text{ V}$		0.5	2	μA	A
Turn-on time delay	Time from $\overline{PD} = \text{high}$ to $V_{OUT} = 90\%$ of final value, $R_L = 200\ \Omega$		650		ns	C
Turn-off time delay	Time from $\overline{PD} = \text{low}$ to $V_{OUT} = 10\%$ of original value, $R_L = 200\ \Omega$		20			
OUTPUT COMMON-MODE VOLTAGE CONTROL (V_{OCM})						
Small-signal bandwidth	V_{OCM} input = 100 mV_{PP}		23		MHz	C
Slew rate	V_{OCM} input = 1 V_{STEP}		14		V/ μs	C
Gain		0.99	0.996	1.01	V/V	A
Common-mode offset voltage	Offset = output common-mode voltage – V_{OCM} input voltage		± 1	± 5	mV	A
V_{OCM} input bias current	$V_{OCM} = (V_{S+} - V_{S-})/2$		± 20	± 100	nA	A
V_{OCM} input voltage range		0.8	0.75 to 1.9	1.75	V	A
V_{OCM} input impedance			100 1.6		k Ω pF	C
Default voltage offset from $(V_{S+} - V_{S-})/2$	Offset = output common-mode voltage – $(V_{S+} - V_{S-})/2$		± 3	± 10	mV	A

5.4 Electrical Characteristics: $V_S = 5\text{ V}$

Test conditions at $T_A = +25^\circ\text{C}$, $V_{S+} = 5\text{ V}$, $V_{S-} = 0\text{ V}$, $V_{OCM} = \text{open}$, $V_{OUT} = 2\text{ V}_{PP}$, $R_F = 2\text{ k}\Omega$, $R_L = 2\text{ k}\Omega$ differential, $G = 1\text{ V/V}$, single-ended input, differential output, and input and output referenced to mid-supply, unless otherwise noted.

PARAMETER	CONDITIONS	MIN	TYP	MAX	UNITS	TEST LEVEL ⁽¹⁾
AC PERFORMANCE						
Small-signal bandwidth	$V_{OUT} = 100\text{ mV}_{PP}$, $G = 1$		36		MHz	C
	$V_{OUT} = 100\text{ mV}_{PP}$, $G = 2$		17			
	$V_{OUT} = 100\text{ mV}_{PP}$, $G = 5$		6			
	$V_{OUT} = 100\text{ mV}_{PP}$, $G = 10$		2.7			
Gain-bandwidth product	$V_{OUT} = 100\text{ mV}_{PP}$, $G = 10$		27		MHz	
Large-signal bandwidth	$V_{OUT} = 2\text{ V}_{PP}$, $G = 1$		36		MHz	
Bandwidth for 0.1 dB flatness	$V_{OUT} = 2\text{ V}_{PP}$, $G = 1$		15		MHz	
Slew rate, rise/fall, 25% to 75%	$V_{OUT} = 2 \cdot V_{Step}$		220/390		V/ μs	
Rise/fall time, 10% to 90%			4.6/5.6		ns	
Settling time to 1%, rise and fall			25/20		ns	
Settling time to 0.1%, rise and fall			60/60		ns	
Settling time to 0.01%, rise and fall			150/110		ns	
Overshoot and undershoot, rise and fall				1/1		%
2nd-order harmonic distortion	$f = 1\text{ kHz}$, $V_{OUT} = 1\text{ V}_{RMS}$		-122		dBc	
	$f = 10\text{ kHz}$		-128			
	$f = 1\text{ MHz}$		-60			
3rd-order harmonic distortion	$f = 1\text{ kHz}$, $V_{OUT} = 1\text{ V}_{RMS}$		-130		dBc	
	$f = 10\text{ kHz}$		-137			
	$f = 1\text{ MHz}$		-71			
2nd-order intermodulation distortion	$f = 1\text{ MHz}$, 200 kHz tone spacing,		-85		dBc	
3rd-order intermodulation distortion	V_{OUT} envelope = 2 V_{PP}		-83			
Input voltage noise	$f = 1\text{ kHz}$		10		nV/ $\sqrt{\text{Hz}}$	
Voltage noise 1/f corner frequency			45		Hz	
Input current noise	$f = 100\text{ kHz}$		0.25		pA/ $\sqrt{\text{Hz}}$	
Current noise 1/f corner frequency			6.5		kHz	
Overdrive recovery time	Overdrive = 0.5 V		65		ns	
Output balance error	$V_{OUT} = 100\text{ mV}$, $f = 1\text{ MHz}$		-67		dB	
Closed-loop output impedance	$f = 1\text{ MHz}$ (differential)		2.5		Ω	

(1) Test levels (all values set by characterization and simulation): (A) 100% tested at $+25^\circ\text{C}$; over temperature limits by characterization and simulation. (B) Not tested in production; limits set by characterization and simulation. (C) Typical value only for information.

Electrical Characteristics: $V_S = 5\text{ V}$ (continued)

Test conditions at $T_A = +25^\circ\text{C}$, $V_{S+} = 5\text{ V}$, $V_{S-} = 0\text{ V}$, $V_{OCM} = \text{open}$, $V_{OUT} = 2\text{ V}_{PP}$, $R_F = 2\text{ k}\Omega$, $R_L = 2\text{ k}\Omega$ differential, $G = 1\text{ V/V}$, single-ended input, differential output, and input and output referenced to mid-supply, unless otherwise noted.

PARAMETER	CONDITIONS	MIN	TYP	MAX	UNITS	TEST LEVEL ⁽¹⁾
DC PERFORMANCE						
Open-loop voltage gain (A_{OL})		100	114		dB	A
Input-referred offset voltage	$T_A = +25^\circ\text{C}$		± 200	± 1000	μV	A
	$T_A = 0^\circ\text{C}$ to $+70^\circ\text{C}$			± 1405		B
	$T_A = -40^\circ\text{C}$ to $+85^\circ\text{C}$			± 1650		
	$T_A = -40^\circ\text{C}$ to $+125^\circ\text{C}$			± 2000		
Input offset voltage drift ⁽²⁾	$T_A = 0^\circ\text{C}$ to $+70^\circ\text{C}$		± 1.7	± 9	$\mu\text{V}/^\circ\text{C}$	B
	$T_A = -40^\circ\text{C}$ to $+85^\circ\text{C}$		± 2	± 10		
	$T_A = -40^\circ\text{C}$ to $+125^\circ\text{C}$		± 2	± 10		
Input bias current	$T_A = +25^\circ\text{C}$		160	210	nA	A
	$T_A = 0^\circ\text{C}$ to $+70^\circ\text{C}$			222		B
	$T_A = -40^\circ\text{C}$ to $+85^\circ\text{C}$			223		
	$T_A = -40^\circ\text{C}$ to $+125^\circ\text{C}$			235		
Input bias current drift ⁽²⁾	$T_A = 0^\circ\text{C}$ to $+70^\circ\text{C}$		0.04	0.25	nA/ $^\circ\text{C}$	B
	$T_A = -40^\circ\text{C}$ to $+85^\circ\text{C}$		0.04	0.25		
	$T_A = -40^\circ\text{C}$ to $+125^\circ\text{C}$		0.04	0.25		
Input offset current	$T_A = +25^\circ\text{C}$		± 5	± 50	nA	A
	$T_A = 0^\circ\text{C}$ to $+70^\circ\text{C}$			± 59		B
	$T_A = -40^\circ\text{C}$ to $+85^\circ\text{C}$			± 60		
	$T_A = -40^\circ\text{C}$ to $+125^\circ\text{C}$			± 75		
Input offset current drift ⁽²⁾	$T_A = 0^\circ\text{C}$ to $+70^\circ\text{C}$		± 0.05	± 0.2	nA/ $^\circ\text{C}$	B
	$T_A = -40^\circ\text{C}$ to $+85^\circ\text{C}$		± 0.05	± 0.2		
	$T_A = -40^\circ\text{C}$ to $+125^\circ\text{C}$		± 0.05	± 0.2		
INPUT						
Common-mode input: low	$T_A = +25^\circ\text{C}$, CMRR > 87 dB		$V_{S-} - 0.2$	V_{S-}	V	A
	$T_A = -40^\circ\text{C}$ to $+125^\circ\text{C}$, CMRR > 87 dB		$V_{S-} - 0.2$	V_{S-}		B
Common-mode input: high	$T_A = +25^\circ\text{C}$, CMRR > 87 dB		$V_{S+} - 1.2$	$V_{S+} - 1.1$	V	A
	$T_A = -40^\circ\text{C}$ to $+125^\circ\text{C}$, CMRR > 87 dB		$V_{S+} - 1.2$	$V_{S+} - 1.1$		B
Common-mode rejection ratio		90	116		dB	A
Input impedance common-mode			200 1.2		k Ω pF	C
Input impedance differential mode			200 1			C
OUTPUT						
Linear output voltage: low	$T_A = +25^\circ\text{C}$		$V_{S-} + 0.1$	$V_{S-} + 0.2$	V	A
	$T_A = -40^\circ\text{C}$ to $+125^\circ\text{C}$		$V_{S-} + 0.1$	$V_{S-} + 0.2$		B
Linear output voltage: high	$T_A = +25^\circ\text{C}$		$V_{S+} - 0.25$	$V_{S+} - 0.12$	V	A
	$T_A = -40^\circ\text{C}$ to $+125^\circ\text{C}$		$V_{S+} - 0.25$	$V_{S+} - 0.12$		B
Output saturation voltage: high/low			120/100		mV	C
Linear output current drive	$T_A = +25^\circ\text{C}$		± 15	± 25	mA	A
	$T_A = -40^\circ\text{C}$ to $+125^\circ\text{C}$		± 15			B

(2) Input offset voltage drift, input bias current drift, and input offset current drift are average values calculated by taking data at the end points, computing the difference, and dividing by the temperature range.

Electrical Characteristics: $V_S = 5\text{ V}$ (continued)

Test conditions at $T_A = +25^\circ\text{C}$, $V_{S+} = 5\text{ V}$, $V_{S-} = 0\text{ V}$, $V_{OCM} = \text{open}$, $V_{OUT} = 2\text{ V}_{PP}$, $R_F = 2\text{ k}\Omega$, $R_L = 2\text{ k}\Omega$ differential, $G = 1\text{ V/V}$, single-ended input, differential output, and input and output referenced to mid-supply, unless otherwise noted.

PARAMETER	CONDITIONS	MIN	TYP	MAX	UNITS	TEST LEVEL ⁽¹⁾
POWER SUPPLY						
Specified operating voltage		2.5		5.5	V	B
Quiescent operating current/ch	$T_A = 25^\circ\text{C}$, $\overline{PD} = V_{S+}$		250	350	μA	A
	$T_A = -40^\circ\text{C}$ to 125°C , $\overline{PD} = V_{S+}$		290	390		B
Power-supply rejection ($\pm\text{PSRR}$)		87	108		dB	A
POWER DOWN						
Enable voltage threshold	Specified on above 2.1 V			2.1	V	A
Disable voltage threshold	Specified off below 0.7 V	0.7				A
Disable pin bias current	$\overline{PD} = V_{S-} + 0.5\text{ V}$		50	500	nA	A
Power-down quiescent current	$\overline{PD} = V_{S-} + 0.5\text{ V}$		0.5	2	μA	A
Turn-on time delay	Time from $\overline{PD} = \text{high}$ to $V_{OUT} = 90\%$ of final value, $R_L = 200\ \Omega$		600		ns	C
Turn-off time delay	Time from $\overline{PD} = \text{low}$ to $V_{OUT} = 10\%$ of original value, $R_L = 200\ \Omega$		15			
OUTPUT COMMON-MODE VOLTAGE CONTROL (V_{OCM})						
Small-signal bandwidth	V_{OCM} input = 100 mV_{PP}		24		MHz	C
Slew rate	V_{OCM} input = 1 V_{STEP}		15		V/ μs	C
Gain		0.99	0.996	1.01	V/V	A
Common-mode offset voltage	Offset = output common-mode voltage – V_{OCM} input voltage		± 1	± 5	mV	A
V_{OCM} input bias current	$V_{OCM} = (V_{S+} - V_{S-})/2$		± 20	± 120	nA	A
V_{OCM} input voltage range		0.95	0.75 to 4.15	4.0	V	A
V_{OCM} input impedance			65 0.86		k Ω pF	C
Default voltage offset from $(V_{S+} - V_{S-})/2$	Offset = output common-mode voltage – $(V_{S+} - V_{S-})/2$		± 3	± 10	mV	A

6 Device Information

6.1 PIN Configurations

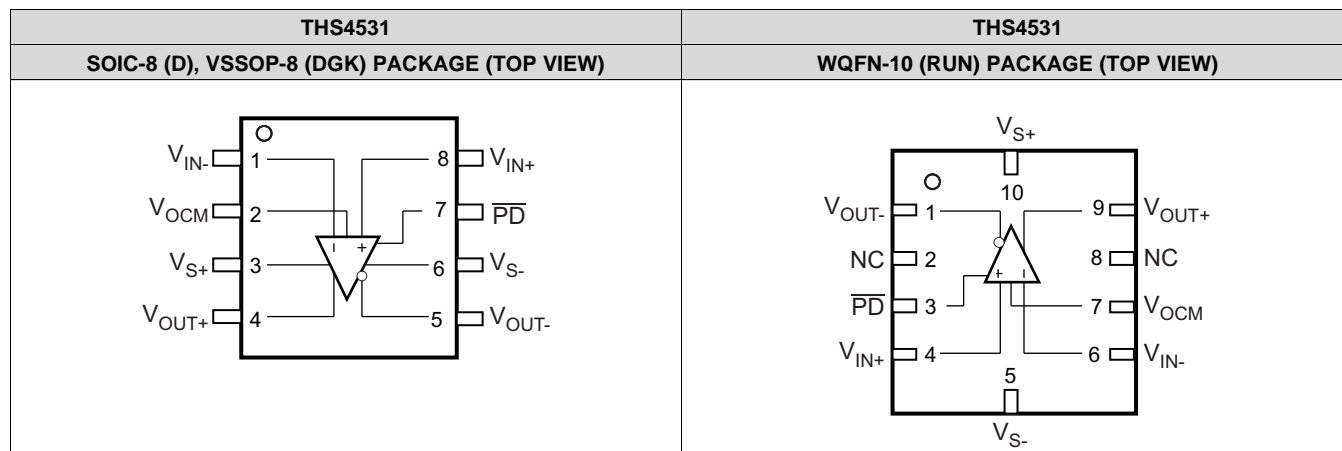
Table 3. PIN Functions

NUMBER	NAME	DESCRIPTION
THS4531 D, DGK PACKAGE		
1	V_{IN-}	Inverted (negative) output feedback
2	V_{OCM}	Common-mode voltage input
3	V_{S+}	Amplifier positive power-supply input
4	V_{OUT+}	Non-inverted amplifier output
5	V_{OUT-}	Inverted amplifier output
6	V_{S-}	Amplifier negative power-supply input. Note: V_{S-} tied together on multichannel devices.
7	\overline{PD}	Power-down, \overline{PD} = logic low = low power mode, \overline{PD} = logic high = normal operation (<i>pin must be driven</i>)
8	V_{IN+}	Non-inverted amplifier input
THS4531 RUN PACKAGE		
1	V_{OUT-}	Inverted amplifier output
2, 8	NC	No internal connection
3	\overline{PD}	Power-down, \overline{PD} = logic low = low power mode, \overline{PD} = logic high = normal operation (<i>pin must be driven</i>)
4	V_{IN+}	Noninverted amplifier input
5	V_{S-}	Amplifier negative power-supply input. Note: V_{S-} tied together on multichannel devices.
6	V_{IN-}	Inverting amplifier input
7	V_{OCM}	Common-mode voltage input
9	V_{OUT+}	Noninverted amplifier output
10	V_{S+}	Amplifier positive power-supply input

6.2 Table of Graphs

Description	$V_S = 2.7\text{ V}$	$V_S = 5\text{ V}$
Small-signal frequency response	Figure 2	Figure 35
Large-signal frequency response	Figure 3	Figure 36
Large- and small-signal pulse response	Figure 4	Figure 37
Single-ended slew rate versus V_{OUT} step	Figure 5	Figure 38
Differential slew rate versus V_{OUT} step	Figure 6	Figure 39
Overdrive recovery	Figure 7	Figure 40
10-kHz FFT on audio analyzer	Figure 8	Figure 41
Harmonic distortion versus frequency	Figure 9	Figure 42
Harmonic distortion versus output voltage at 1 MHz	Figure 10	Figure 43
Harmonic distortion versus gain at 1 MHz	Figure 11	Figure 44
Harmonic distortion versus load at 1 MHz	Figure 12	Figure 45
Harmonic distortion versus V_{OCM} at 1 MHz	Figure 13	Figure 46
Two-tone, 2nd and 3rd order intermodulation distortion versus frequency	Figure 14	Figure 47
Single-ended output voltage swing versus load resistance	Figure 15	Figure 48
Single-ended output saturation voltage versus load current	Figure 16	Figure 49
Main amplifier differential output impedance versus frequency	Figure 17	Figure 50
Frequency response versus C_{LOAD}	Figure 18	Figure 51
R_O versus C_{LOAD}	Figure 19	Figure 52
Rejection ratio versus frequency	Figure 20	Figure 53
Turn-on time	Figure 21	Figure 54
Turn-off time	Figure 22	Figure 55
Input-referred voltage noise and current noise spectral density	Figure 23	Figure 56
Main amplifier differential open-loop gain and phase versus frequency	Figure 24	Figure 57
Output balance error versus frequency	Figure 25	Figure 58
V_{OCM} small signal frequency response	Figure 26	Figure 59
V_{OCM} large and small signal pulse response	Figure 27	Figure 60
V_{OCM} input impedance versus frequency	Figure 28	Figure 61
Count versus input offset current	Figure 29	Figure 62
Count versus input offset current temperature drift	Figure 30	Figure 63
Input offset current versus temperature	Figure 31	Figure 64
Count versus input offset voltage	Figure 32	Figure 65
Count versus input offset voltage temperature drift	Figure 33	Figure 66
Input offset voltage versus temperature	Figure 34	Figure 67

7 Typical Characteristics: $V_S = 2.7\text{ V}$

Test conditions unless otherwise noted: $V_{S+} = 2.7\text{ V}$, $V_{S-} = 0\text{ -}$, CM = open, $V_{OUT} = 2\text{ Vpp}$, $R_F = 2\text{ k}\Omega$, $R_L = 2\text{ k}\Omega$ differential, $G = 1\text{ V/V}$, single-ended input, differential output, input and output referenced to mid-supply unless otherwise noted.

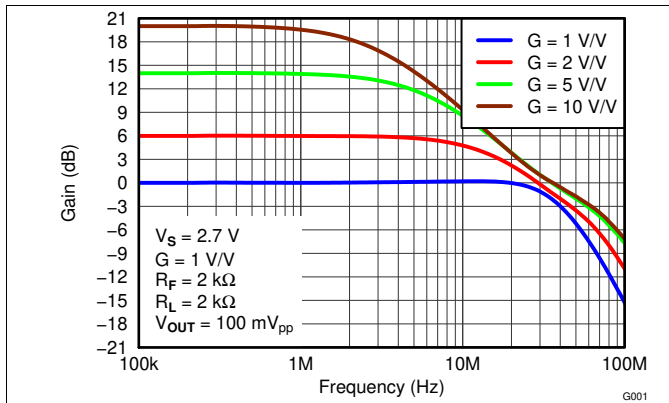

Figure 2. Small-Signal Frequency Response

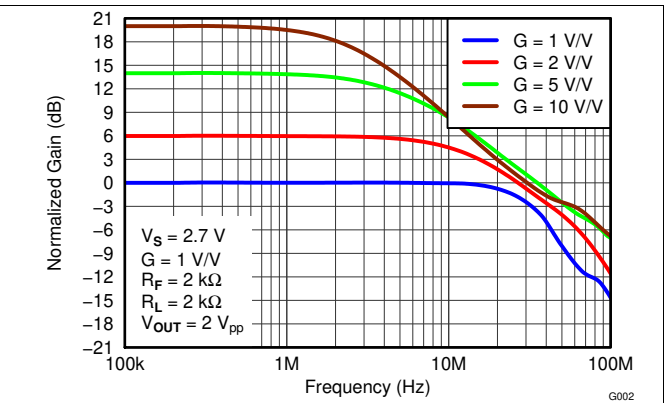

Figure 3. Large-Signal Frequency Response

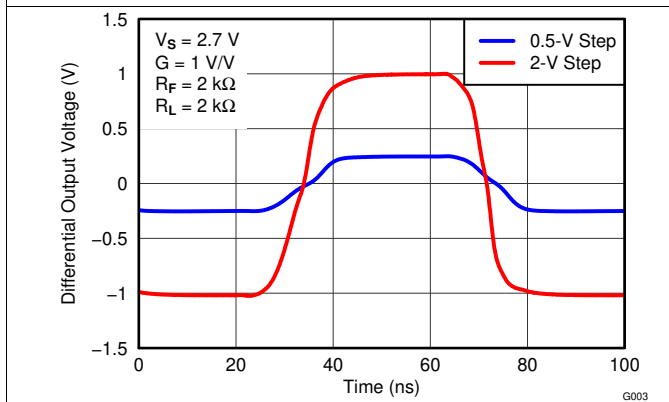

Figure 4. Large and Small-Signal Pulse Response

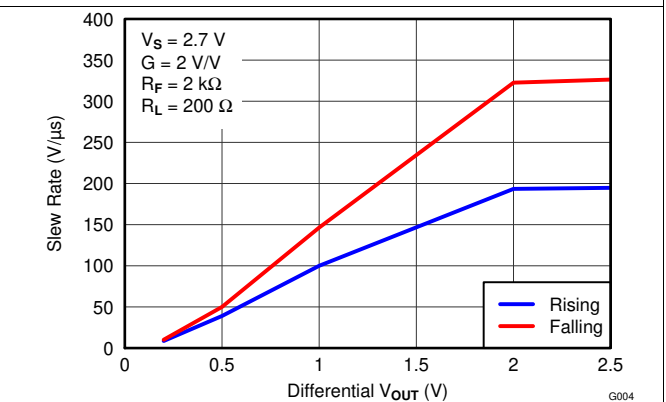

Figure 5. Single-Sided Slew Rate vs V_{OUT} Step

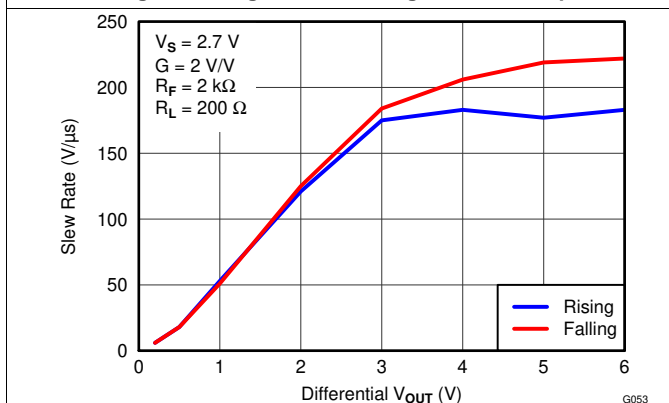

Figure 6. Differential Slew Rate vs V_{OUT} Step

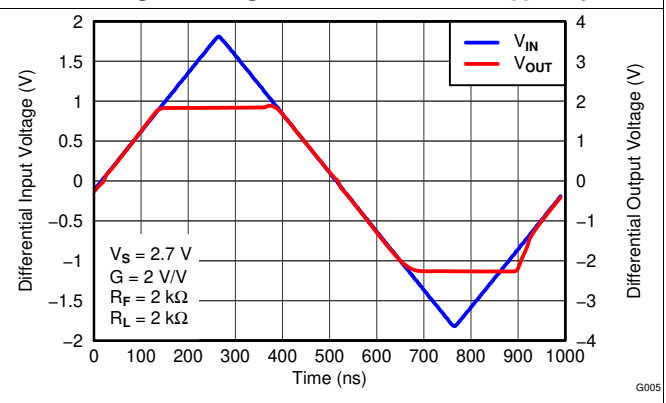

Figure 7. Overdrive Recovery

Typical Characteristics: $V_S = 2.7\text{ V}$ (continued)

Test conditions unless otherwise noted: $V_{S+} = 2.7\text{ V}$, $V_{S-} = 0\text{ V}$, CM = open, $V_{OUT} = 2\text{ V}_{pp}$, $R_F = 2\text{ k}\Omega$, $R_L = 2\text{ k}\Omega$ differential, $G = 1\text{ V/V}$, single-ended input, differential output, input and output referenced to mid-supply unless otherwise noted.

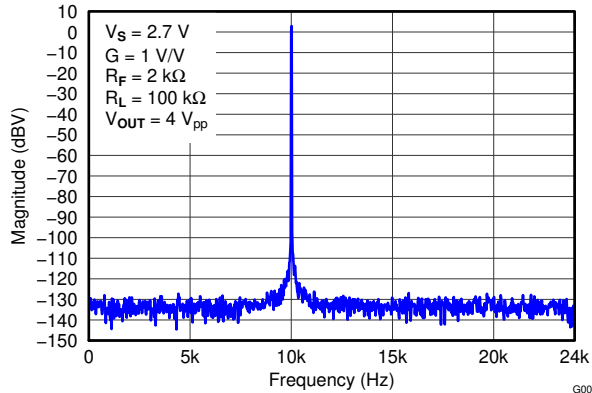

Figure 8. 10 kHz FFT On Audio Analyzer

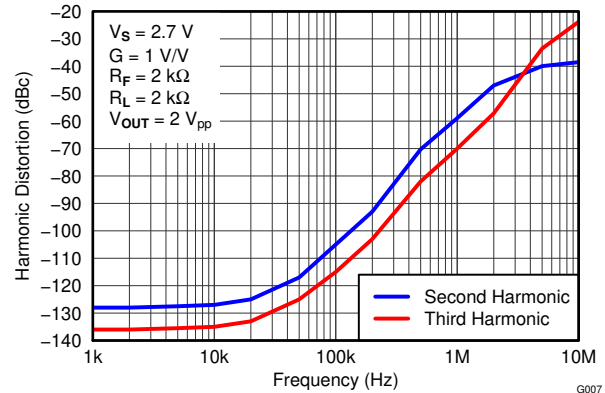

Figure 9. Harmonic Distortion vs Frequency

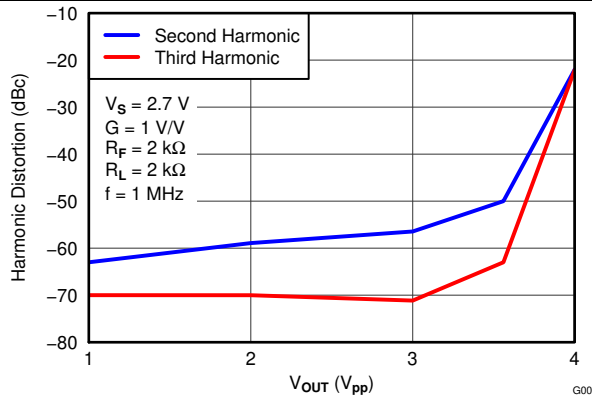

Figure 10. Harmonic Distortion vs Output Voltage at 1 MHz

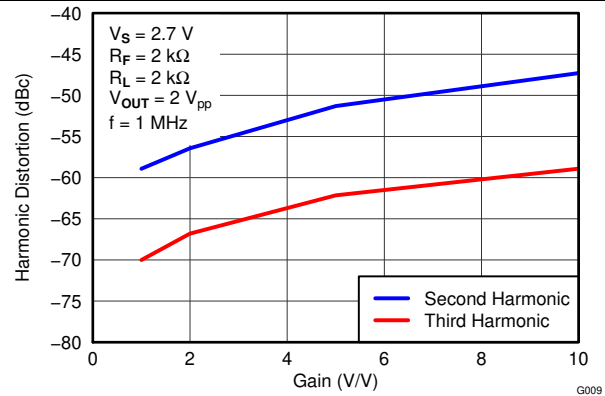

Figure 11. Harmonic Distortion vs GAIN at 1 MHz

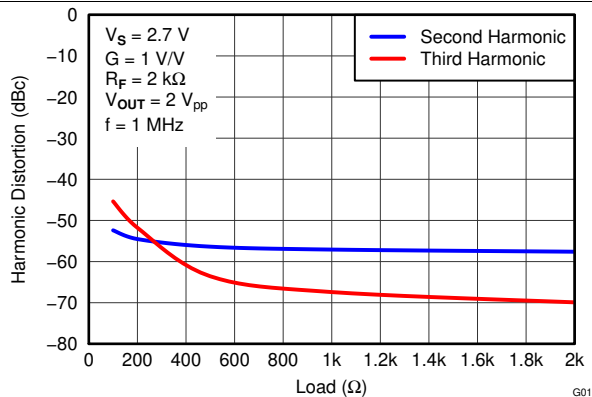

Figure 12. Harmonic Distortion vs Load at 1 MHz

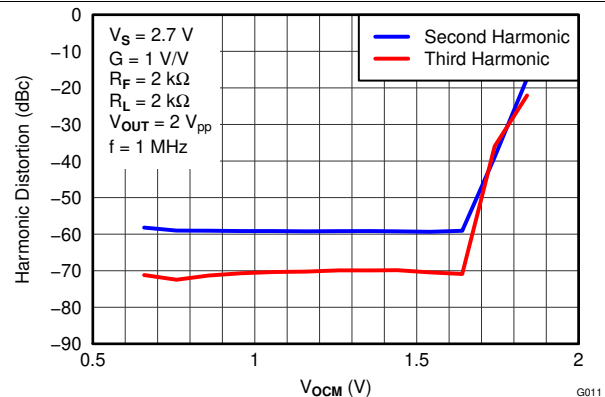
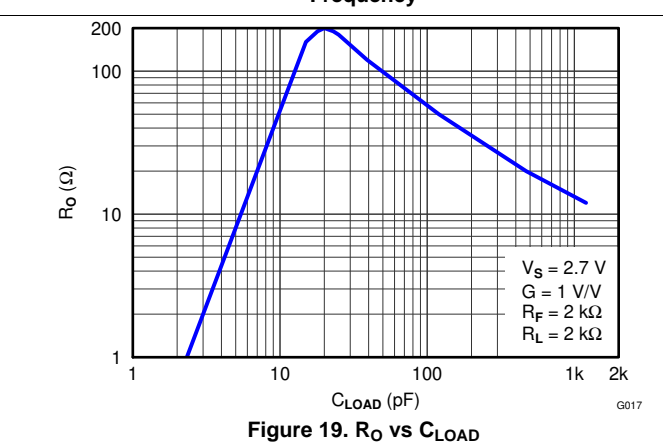
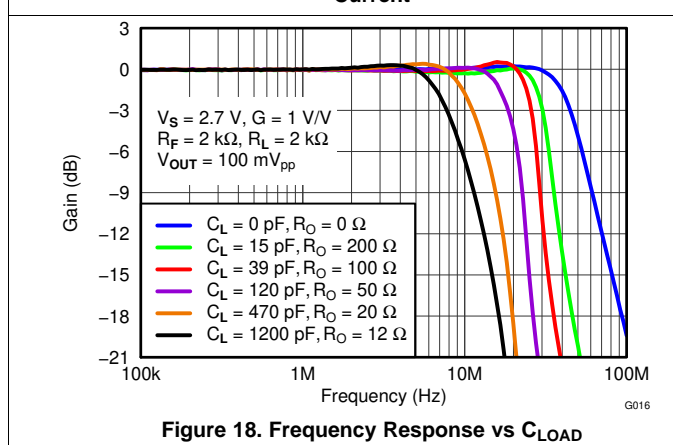
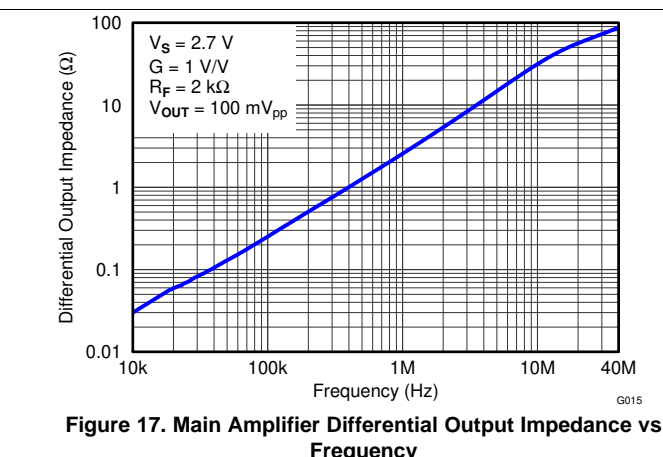
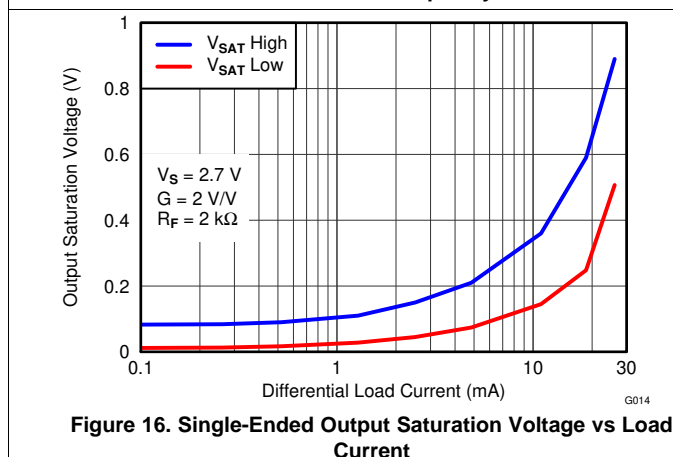
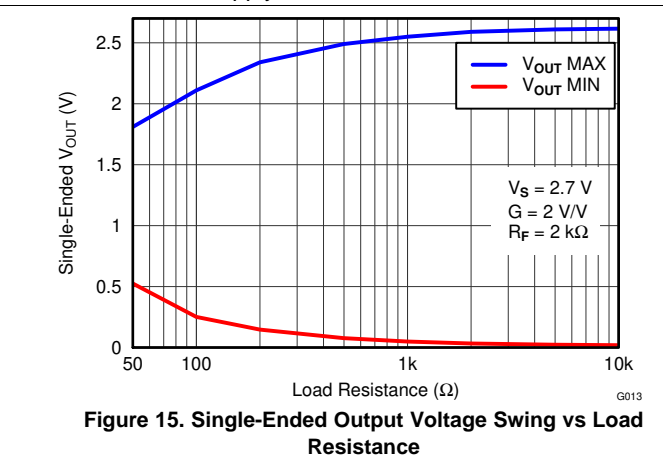
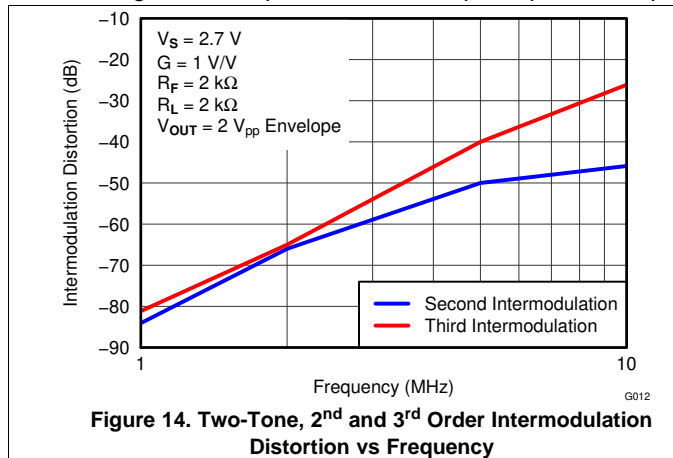

Figure 13. Harmonic Distortion vs V_{OCM} at 1 MHz

Typical Characteristics: $V_S = 2.7\text{ V}$ (continued)

Test conditions unless otherwise noted: $V_{S+} = 2.7\text{ V}$, $V_{S-} = 0\text{ -}$, $C_M = \text{open}$, $V_{OUT} = 2\text{ V}_{pp}$, $R_F = 2\text{ k}\Omega$, $R_L = 2\text{ k}\Omega$ differential, $G = 1\text{ V/V}$, single-ended input, differential output, input and output referenced to mid-supply unless otherwise noted.



Typical Characteristics: $V_S = 2.7\text{ V}$ (continued)

Test conditions unless otherwise noted: $V_{S+} = 2.7\text{ V}$, $V_{S-} = 0\text{ -}$, $C_M = \text{open}$, $V_{OUT} = 2\text{ Vpp}$, $R_F = 2\text{ k}\Omega$, $R_L = 2\text{ k}\Omega$ differential, $G = 1\text{ V/V}$, single-ended input, differential output, input and output referenced to mid-supply unless otherwise noted.

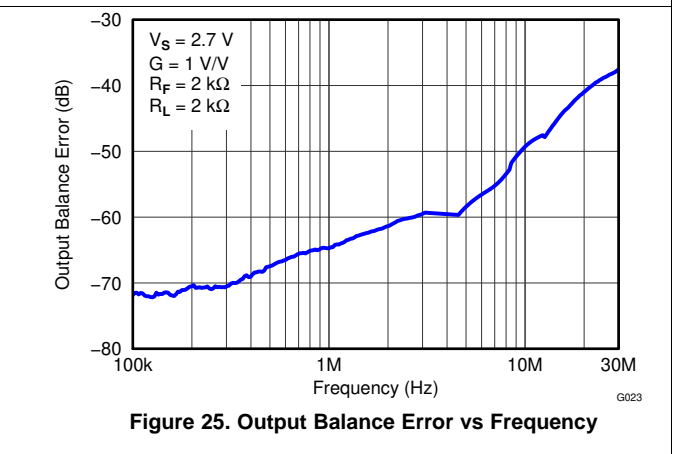
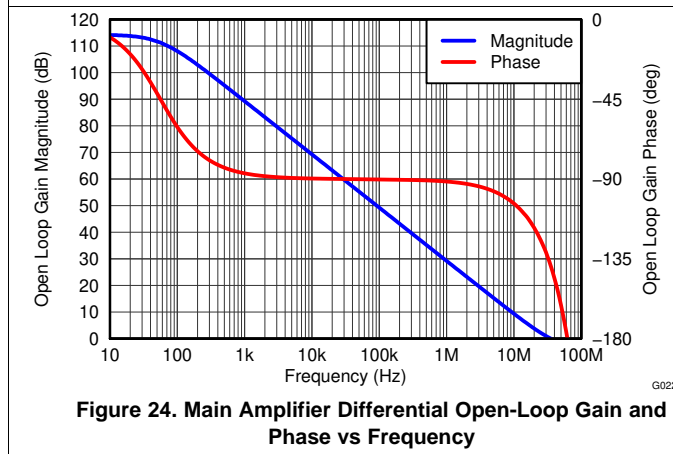
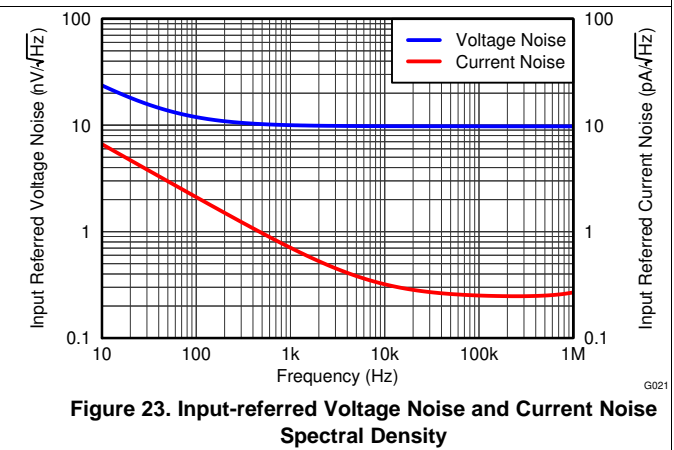
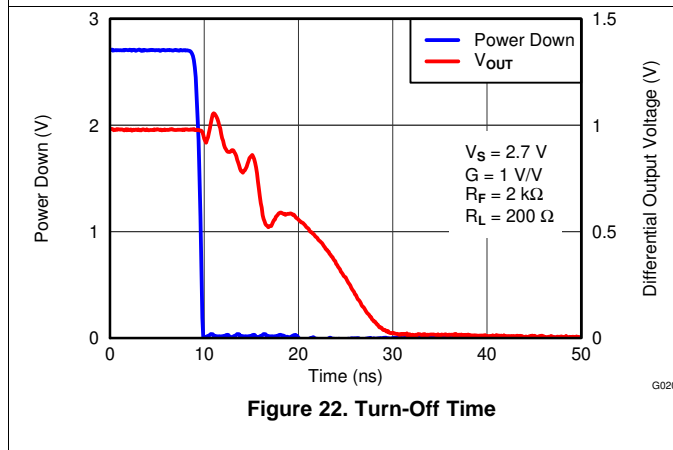
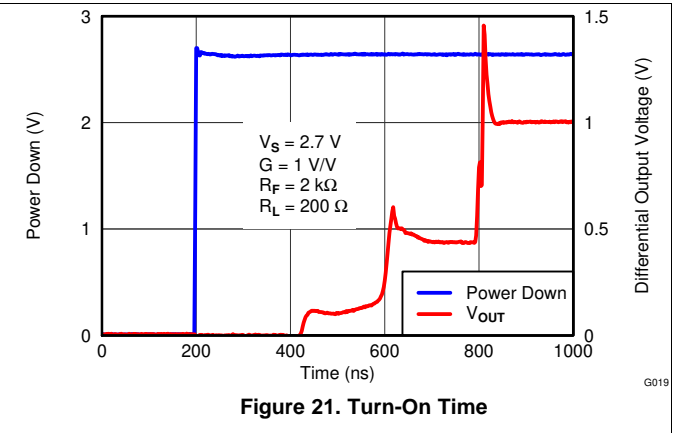
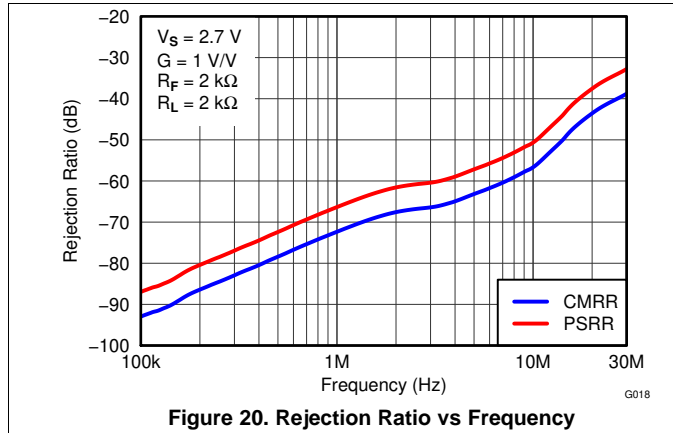

Typical Characteristics: $V_S = 2.7\text{ V}$ (continued)

Test conditions unless otherwise noted: $V_{S+} = 2.7\text{ V}$, $V_{S-} = 0\text{ -}$, CM = open, $V_{OUT} = 2\text{ Vpp}$, $R_F = 2\text{ k}\Omega$, $R_L = 2\text{ k}\Omega$ differential, $G = 1\text{ V/V}$, single-ended input, differential output, input and output referenced to mid-supply unless otherwise noted.

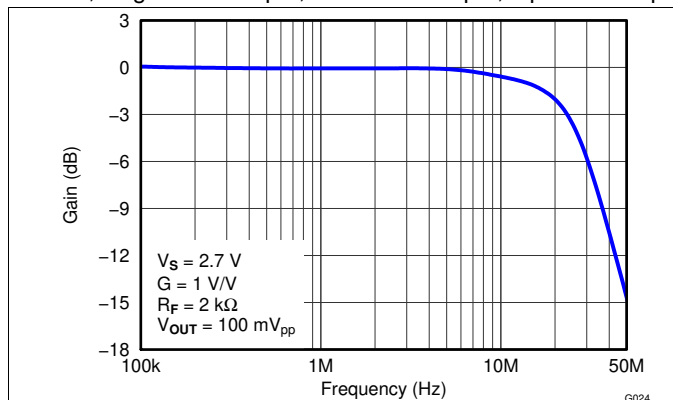

Figure 26. V_{OCM} Small-Signal Frequency Response

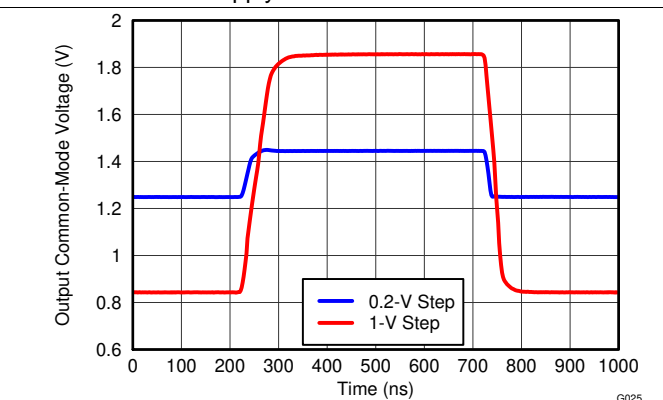

Figure 27. V_{OCM} Large and Small-Signal Pulse Response

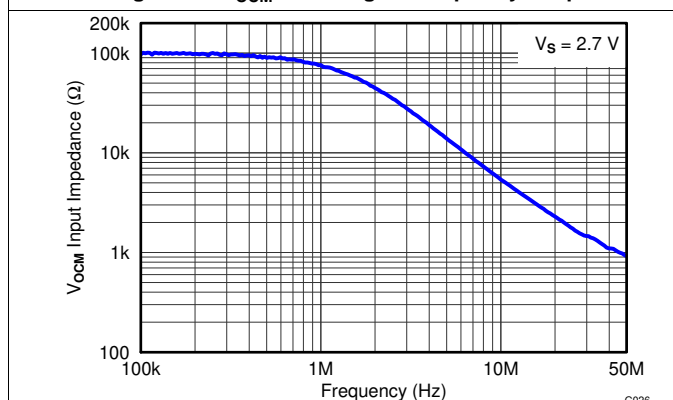

Figure 28. V_{OCM} Input Impedance vs Frequency

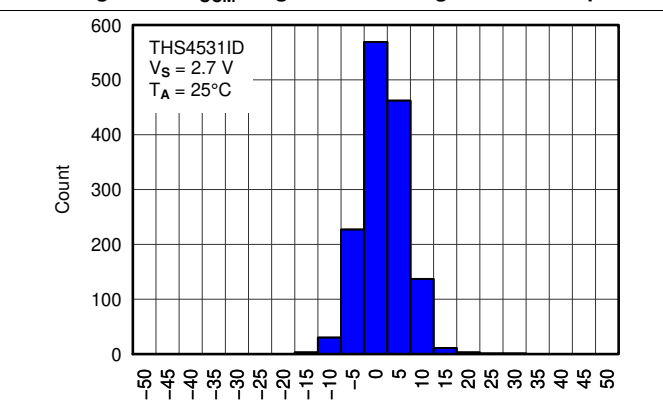

Figure 29. Input Offset Current Histogram

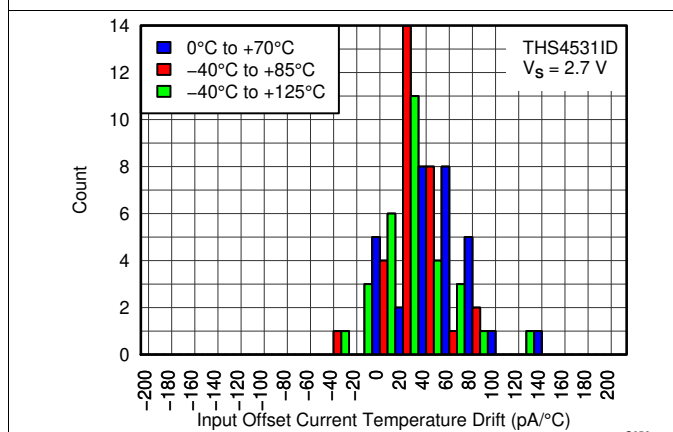

Figure 30. Input Offset Current Temperature Drift Histogram

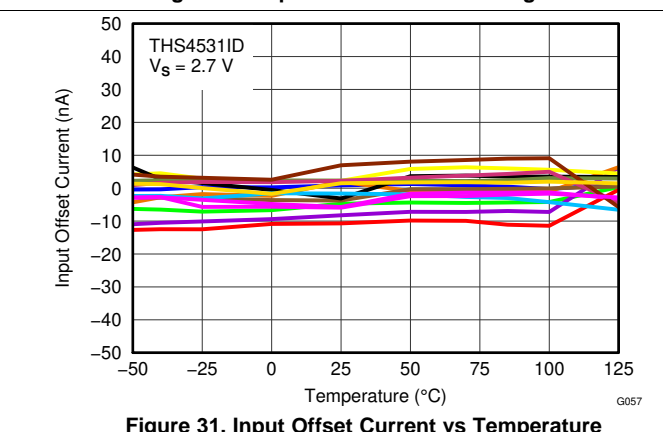

Figure 31. Input Offset Current vs Temperature

Typical Characteristics: $V_S = 2.7\text{ V}$ (continued)

Test conditions unless otherwise noted: $V_{S+} = 2.7\text{ V}$, $V_{S-} = 0\text{ -}$, CM = open, $V_{OUT} = 2\text{ Vpp}$, $R_F = 2\text{ k}\Omega$, $R_L = 2\text{ k}\Omega$ differential, G = 1 V/V, single-ended input, differential output, input and output referenced to mid-supply unless otherwise noted.

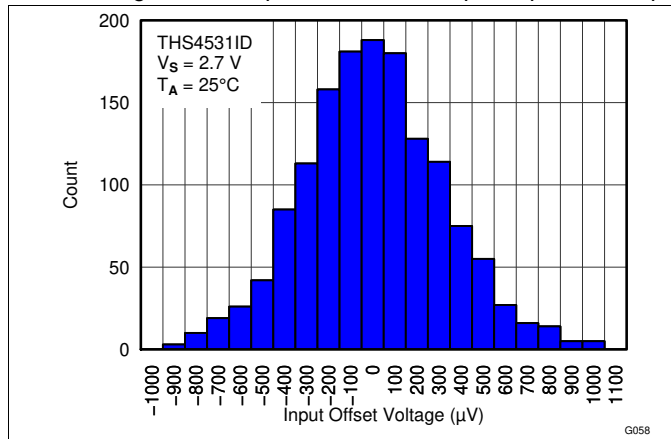

Figure 32. Input Offset Voltage Histogram

G058

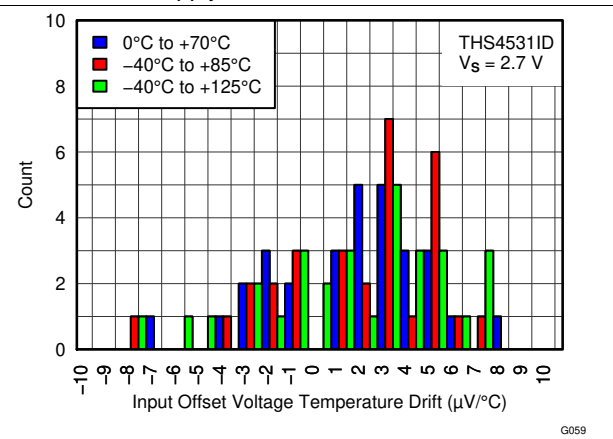

Figure 33. Input Offset Voltage Temperature Drift Histogram

G059

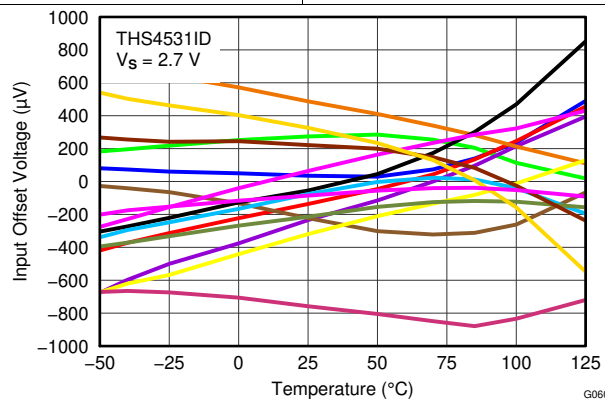

Figure 34. Input Offset Voltage vs Temperature

G060

8 Typical Characteristics: $V_S = 5\text{ V}$

Test conditions unless otherwise noted: $V_{S+} = 5\text{ V}$, $V_{S-} = 0\text{ V}$, $V_{OCM} = \text{open}$, $V_{OUT} = 2\text{ Vpp}$, $R_F = 2\text{ k}\Omega$, $R_L = 2\text{ k}\Omega$ Differential, $G = 1\text{ V/V}$, Single-Ended Input, Differential Output, Input and Output Referenced to mid-supply, $T_A = 25^\circ\text{C}$ unless otherwise noted.

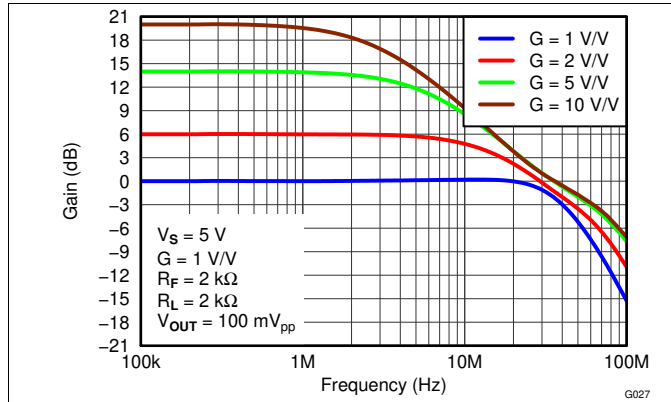

Figure 35. Small-Signal Frequency Response

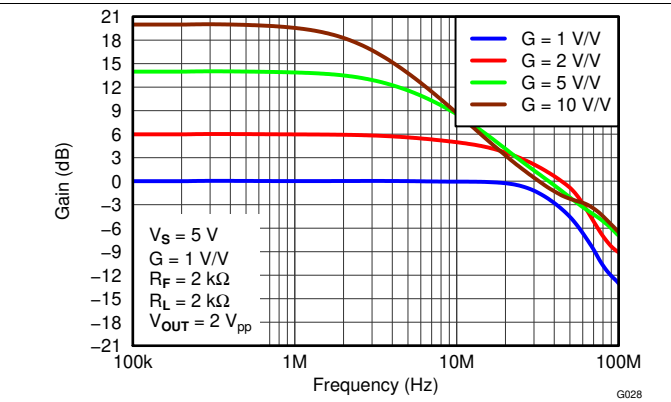

Figure 36. Large-Signal Frequency Response

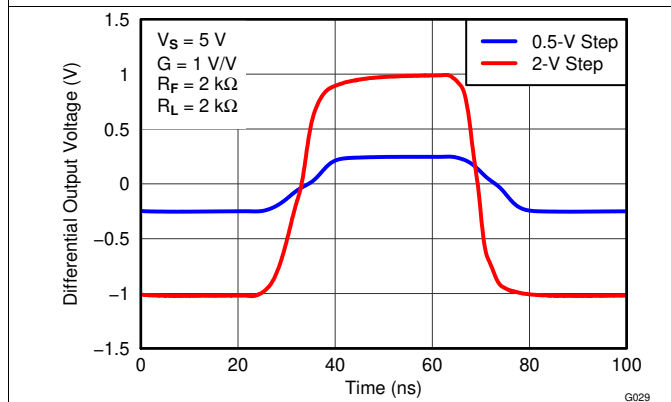

Figure 37. Large and Small-Signal Pulse Response

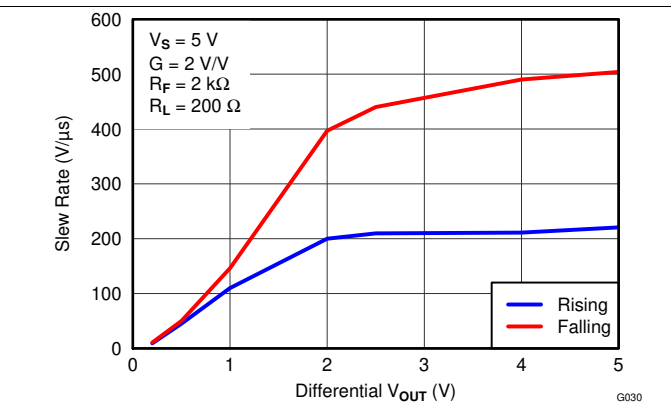

Figure 38. Single-Ended Slew Rate vs V_{OUT} Step

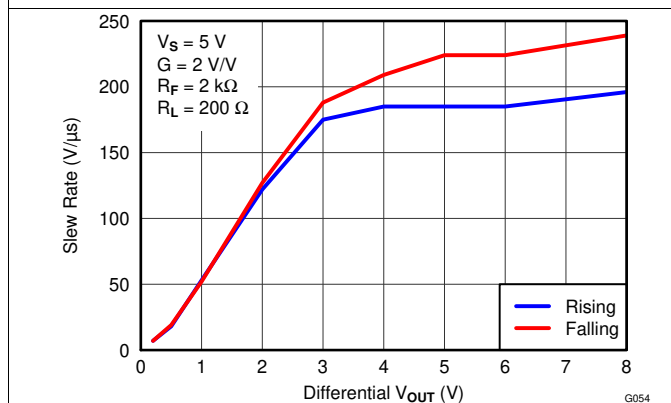

Figure 39. Differential Slew Rate vs V_{OUT} Step

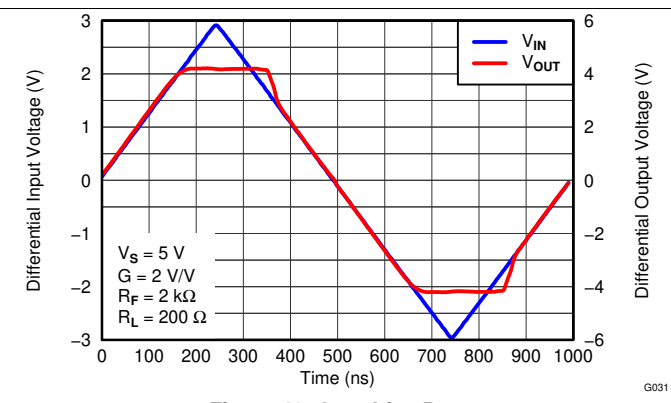

Figure 40. Overdrive Recovery

Typical Characteristics: $V_S = 5\text{ V}$ (continued)

Test conditions unless otherwise noted: $V_{S+} = 5\text{ V}$, $V_{S-} = 0\text{ V}$, $V_{OCM} = \text{open}$, $V_{OUT} = 2\text{ V}_{pp}$, $R_F = 2\text{ k}\Omega$, $R_L = 2\text{ k}\Omega$ Differential, $G = 1\text{ V/V}$, Single-Ended Input, Differential Output, Input and Output Referenced to mid-supply, $T_A = 25^\circ\text{C}$ unless otherwise noted.

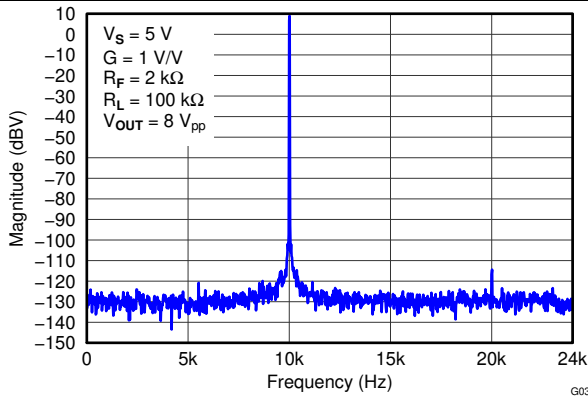

Figure 41. 10 kHz FFT On Audio Analyzer

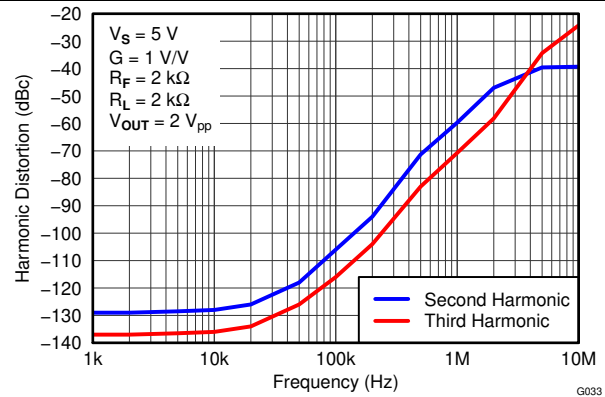

Figure 42. Harmonic Distortion vs Frequency

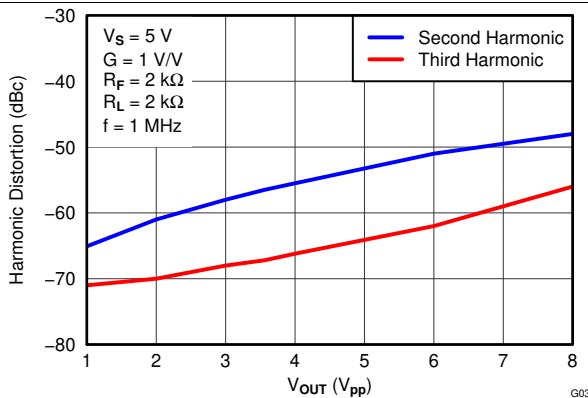

Figure 43. Harmonic Distortion vs Output Voltage at 1 MHz

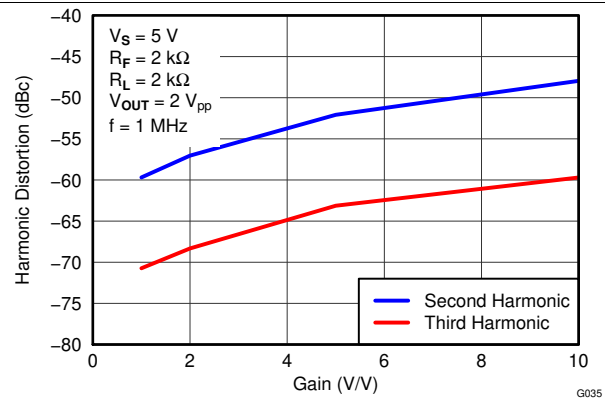

Figure 44. Harmonic Distortion vs Gain at 1 MHz

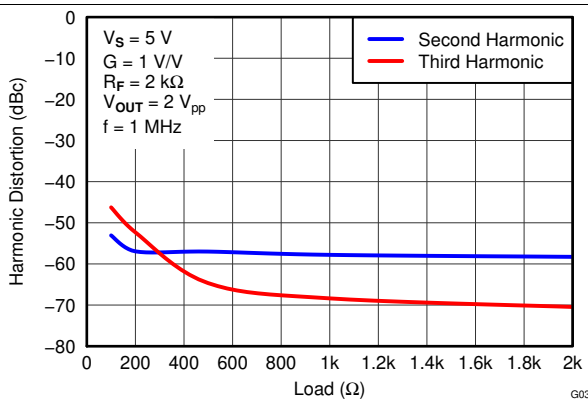

Figure 45. Harmonic Distortion vs Load at 1 MHz

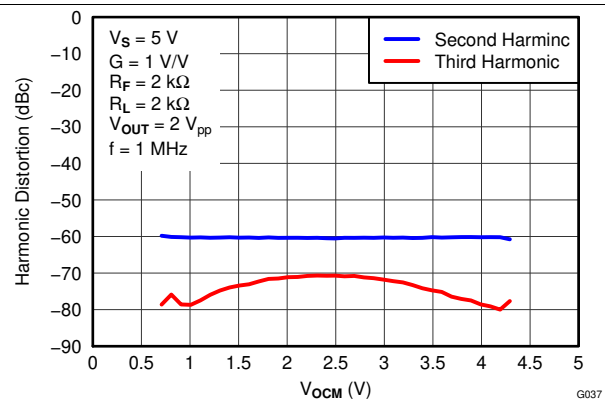

Figure 46. Harmonic Distortion vs V_{OCM} at 1 MHz

Typical Characteristics: $V_S = 5\text{ V}$ (continued)

Test conditions unless otherwise noted: $V_{S+} = 5\text{ V}$, $V_{S-} = 0\text{ V}$, $V_{OCM} = \text{open}$, $V_{OUT} = 2\text{ V}_{pp}$, $R_F = 2\text{ k}\Omega$, $R_L = 2\text{ k}\Omega$ Differential, $G = 1\text{ V/V}$, Single-Ended Input, Differential Output, Input and Output Referenced to mid-supply, $T_A = 25^\circ\text{C}$ unless otherwise noted.

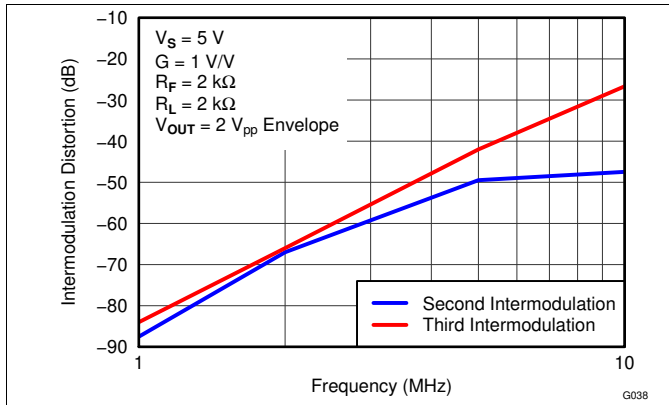

Figure 47. Two-Tone, 2nd and 3rd Order Intermodulation Distortion vs Frequency

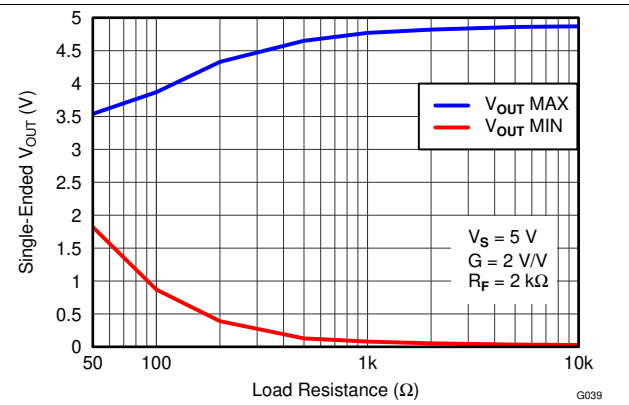

Figure 48. Single-Ended Output Voltage Swing vs Load Resistance

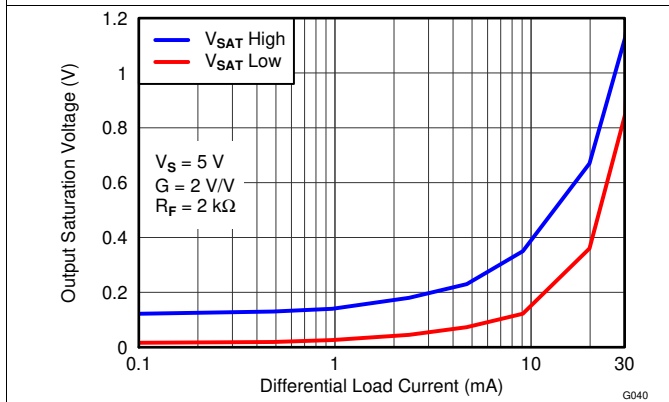

Figure 49. Single-Ended Output Saturation Voltage vs Load Current

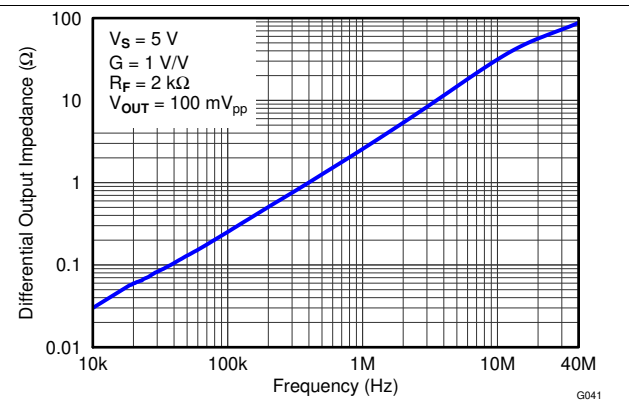

Figure 50. Main Amplifier Differential Output Impedance vs Frequency

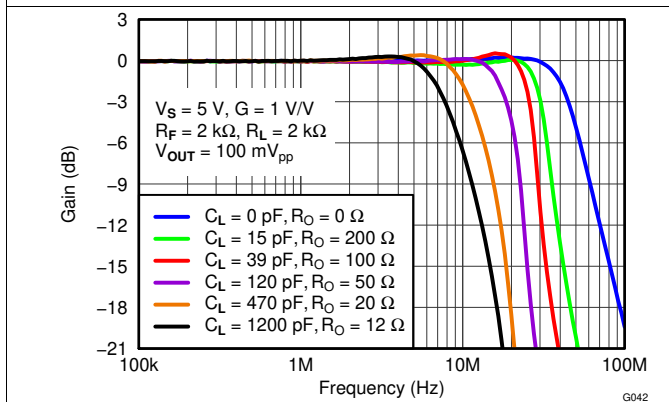

Figure 51. Frequency Response vs C_{LOAD}

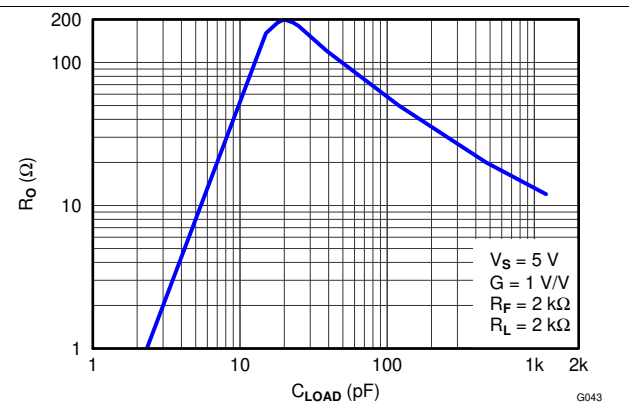

Figure 52. R_O vs C_{LOAD}

Typical Characteristics: $V_S = 5\text{ V}$ (continued)

Test conditions unless otherwise noted: $V_{S+} = 5\text{ V}$, $V_{S-} = 0\text{ V}$, $V_{OCM} = \text{open}$, $V_{OUT} = 2\text{ Vpp}$, $R_F = 2\text{ k}\Omega$, $R_L = 2\text{ k}\Omega$ Differential, $G = 1\text{ V/V}$, Single-Ended Input, Differential Output, Input and Output Referenced to mid-supply, $T_A = 25^\circ\text{C}$ unless otherwise noted.

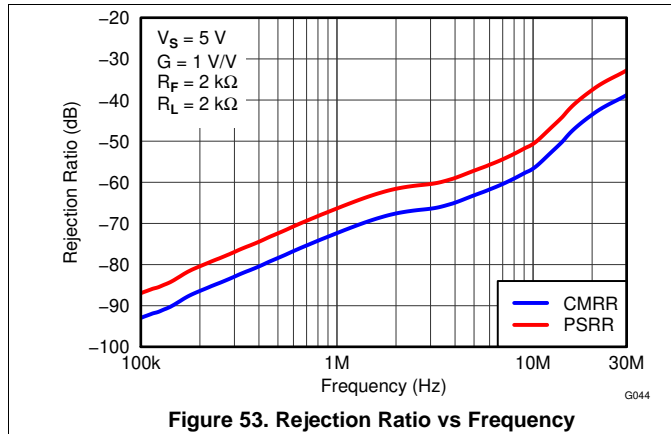

Figure 53. Rejection Ratio vs Frequency

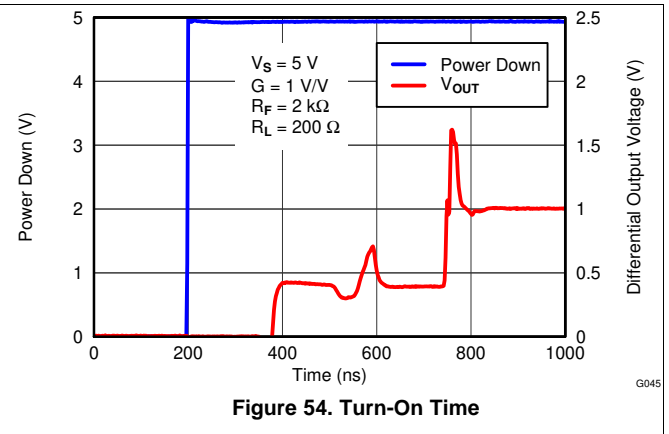

Figure 54. Turn-On Time

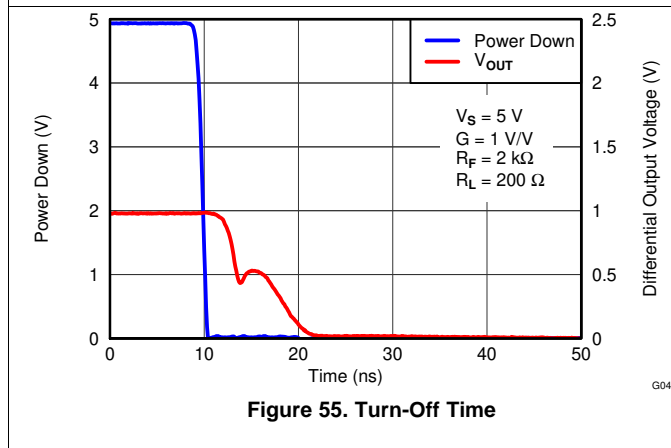

Figure 55. Turn-Off Time

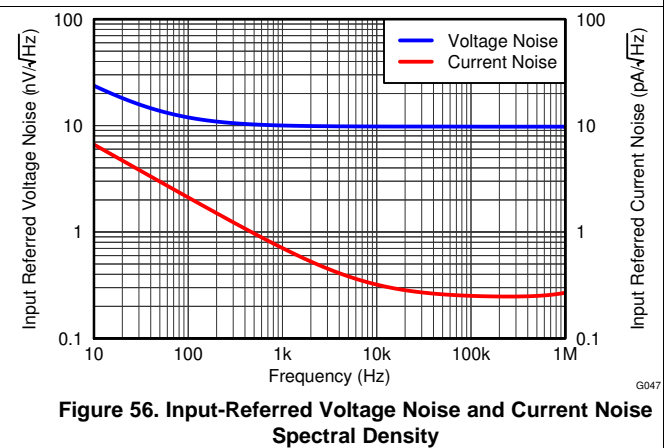

Figure 56. Input-Referred Voltage Noise and Current Noise Spectral Density

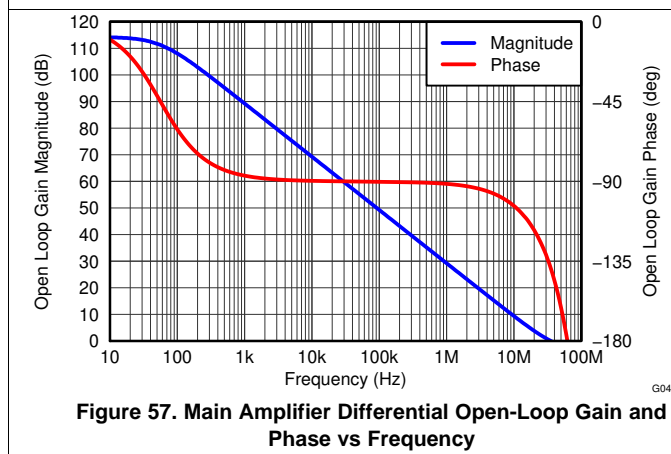

Figure 57. Main Amplifier Differential Open-Loop Gain and Phase vs Frequency

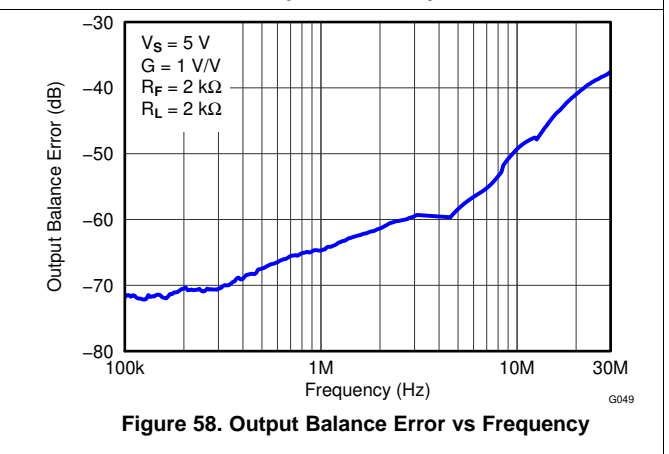

Figure 58. Output Balance Error vs Frequency

Typical Characteristics: $V_S = 5\text{ V}$ (continued)

Test conditions unless otherwise noted: $V_{S+} = 5\text{ V}$, $V_{S-} = 0\text{ V}$, $V_{OCM} = \text{open}$, $V_{OUT} = 2\text{ Vpp}$, $R_F = 2\text{ k}\Omega$, $R_L = 2\text{ k}\Omega$ Differential, $G = 1\text{ V/V}$, Single-Ended Input, Differential Output, Input and Output Referenced to mid-supply, $T_A = 25^\circ\text{C}$ unless otherwise noted.

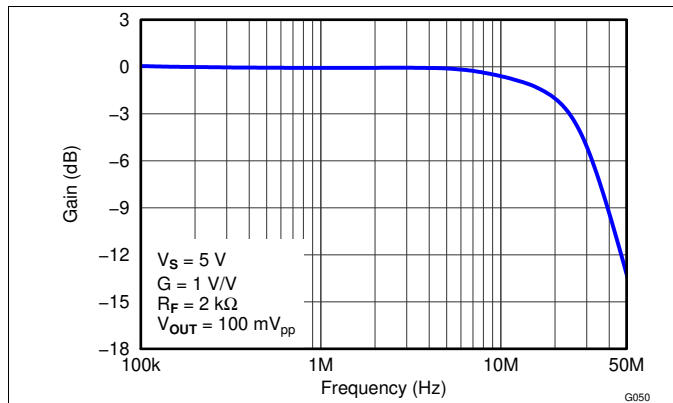

Figure 59. V_{OCM} Small-Signal Frequency Response

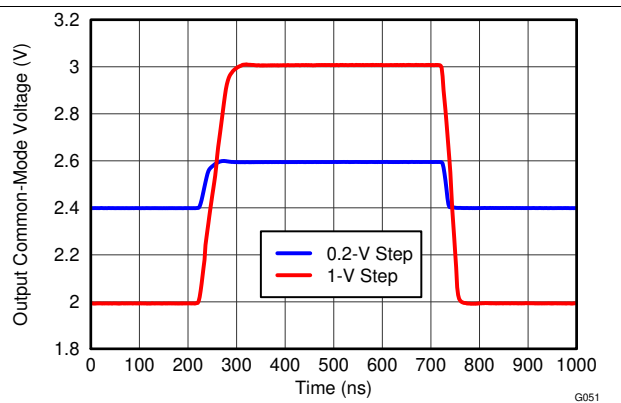

Figure 60. V_{OCM} Large and Small-Signal Pulse Response

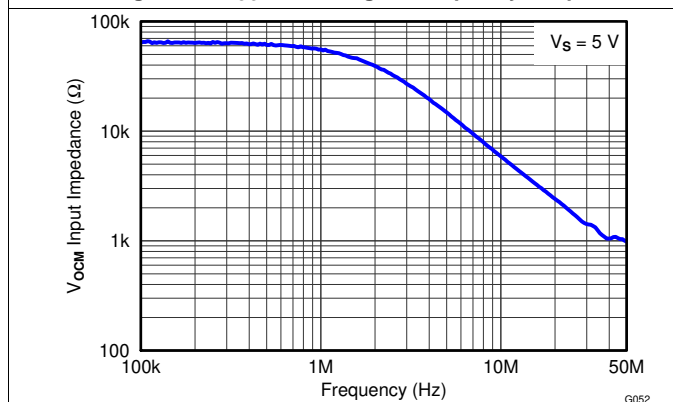

Figure 61. V_{OCM} Input Impedance vs Frequency

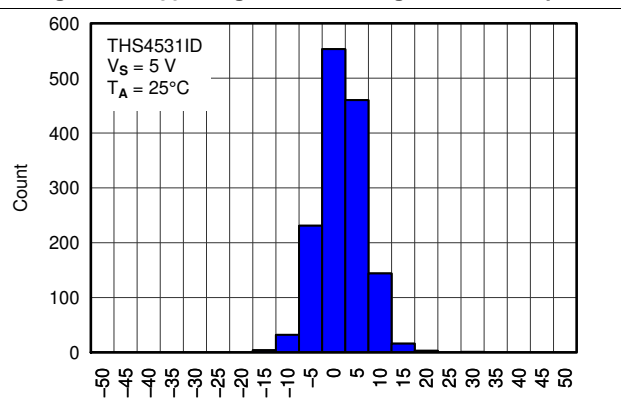

Figure 62. Input Offset Current Histogram

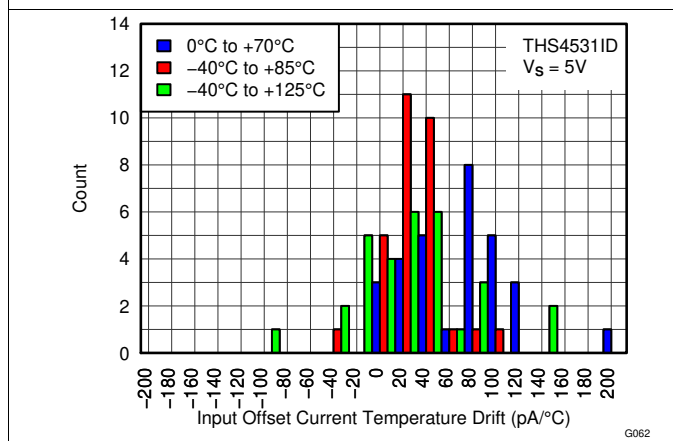

Figure 63. Input Offset Current Temperature Drift Histogram

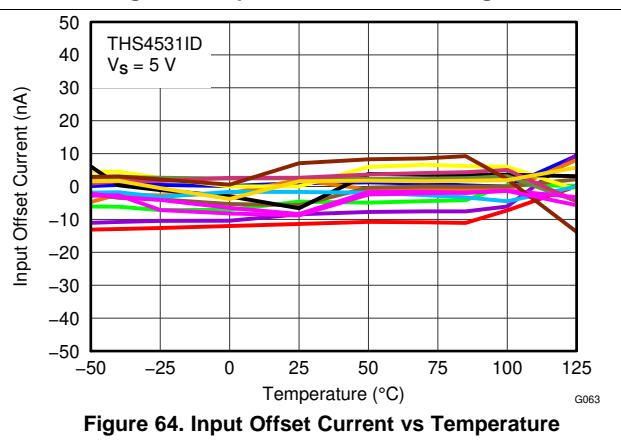

Figure 64. Input Offset Current vs Temperature

Typical Characteristics: $V_S = 5\text{ V}$ (continued)

Test conditions unless otherwise noted: $V_{S+} = 5\text{ V}$, $V_{S-} = 0\text{ V}$, $V_{OCM} = \text{open}$, $V_{OUT} = 2\text{ Vpp}$, $R_F = 2\text{ k}\Omega$, $R_L = 2\text{ k}\Omega$ Differential, $G = 1\text{ V/V}$, Single-Ended Input, Differential Output, Input and Output Referenced to mid-supply, $T_A = 25^\circ\text{C}$ unless otherwise noted.

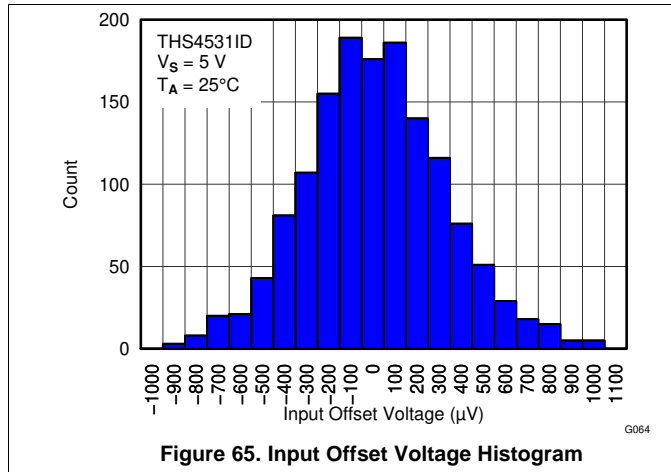

Figure 65. Input Offset Voltage Histogram

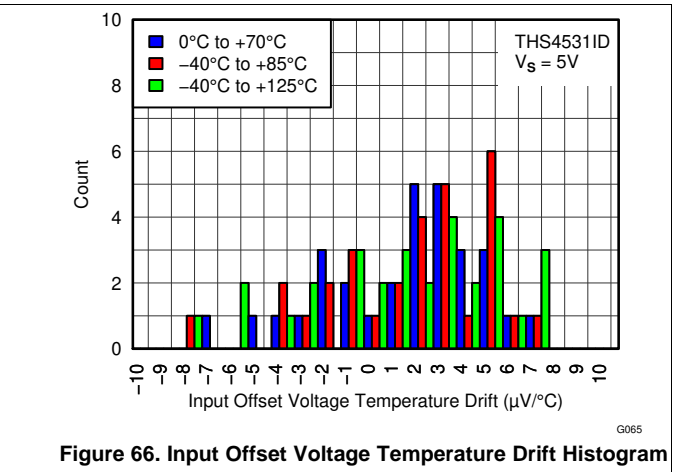

Figure 66. Input Offset Voltage Temperature Drift Histogram

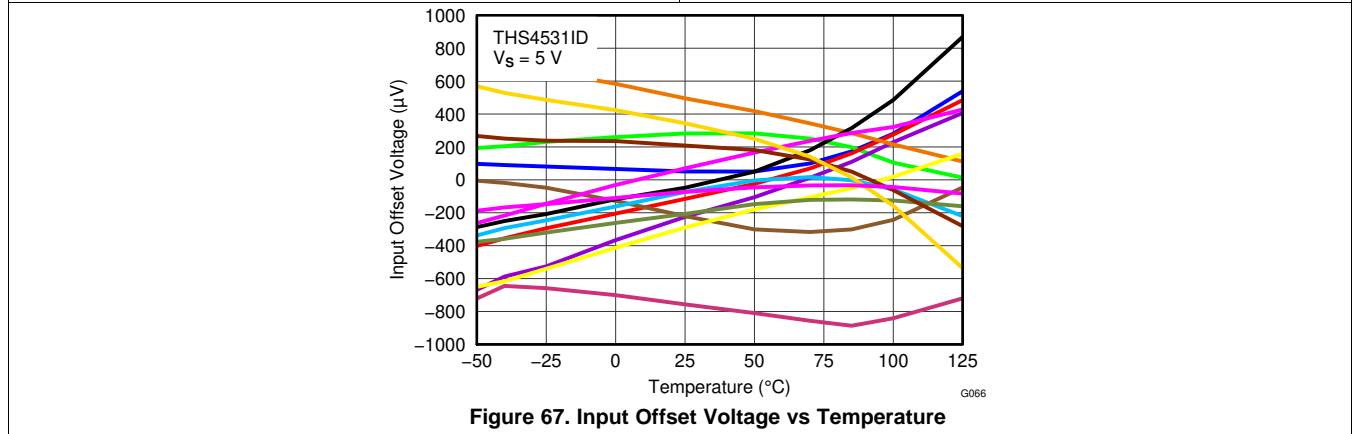

Figure 67. Input Offset Voltage vs Temperature

9 Application Information

9.1 Typical Characteristics Test Circuits

Figure 68 shows the general test circuit built on the EVM that was used for testing the THS4531. For simplicity, power supply decoupling is not shown – please see layout in the applications section for recommendations. Depending on the test conditions, component values are changed per Table 4 and Table 5, or as otherwise noted. Some of the signal generators used are ac coupled 50 Ω sources and a 0.22 μF cap and 49.9 Ω resistor to ground are inserted across R_{IT} on the un-driven or alternate input as shown to balance the circuit. Split-power supply is used to ease the interface to common lab test equipment, but if properly biased, the amplifier can be operated single-supply as described in the applications section with no impact on performance. For most of the tests, the devices are tested with single ended input and a transformer on the output to convert the differential output to single ended because common lab test equipment have single ended inputs and outputs. Performance is the same or better with differential input and differential output.

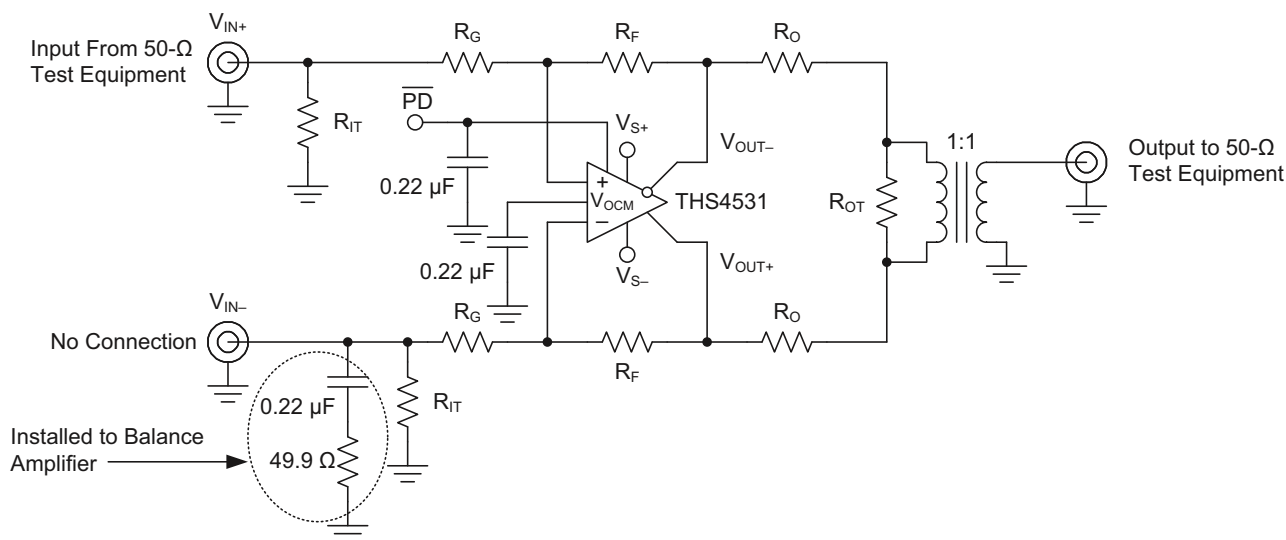

Figure 68. General Test Circuit

Table 4. Gain Component Values for Single-Ended Input⁽¹⁾

GAIN	R_F	R_G	R_{IT}
1 V/V	2 k Ω	2 k Ω	51.1 Ω
2 V/V	2 k Ω	1 k Ω	52.3 Ω
5 V/V	2 k Ω	392 Ω	53.6 Ω
10 V/V	2 k Ω	187 k Ω	57.6 Ω

(1) Note components are chosen to achieve gain and 50- Ω input termination. Resistor values shown are closest standard values so gains are approximate.

Table 5. Load Component Values For 1:1 Differential to Single-Ended Output Transformer⁽¹⁾

R_L	R_O	R_{OT}	ATTEN
100 Ω	25 Ω	open	6
200 Ω	86.6 Ω	69.8 Ω	16.8
499 Ω	237 Ω	56.2 Ω	25.5
1 k Ω	487 Ω	52.3 Ω	31.8
2 k Ω	976 Ω	51.1 Ω	37.9

(1) Note the total load includes 50- Ω termination by the test equipment. Components are chosen to achieve load and 50- Ω line termination through a 1:1 transformer. Resistor values shown are closest standard values so loads are approximate.

Due to the voltage divider on the output formed by the load component values, the amplifier's output is attenuated. The column *Atten* in [Table 5](#) shows the attenuation expected from the resistor divider. When using a transformer at the output as shown in [Figure 68](#), the signal will see slightly more loss due to transformer and line loss, and these numbers will be approximate. The standard output load used for most tests is 2 k Ω with associated 37.9 dB of loss.

9.1.1 Frequency Response and Output Impedance

The circuit shown in [Figure 68](#) is used to measure the frequency response of the amplifier.

A network analyzer is used as the signal source and the measurement device. The output impedance of the network analyzer is 50- Ω and is DC coupled. R_{IT} and R_G are chosen to impedance match to 50 Ω and maintain the proper gain. To balance the amplifier, a 49.9 Ω resistor to ground is inserted across R_{IT} on the alternate input.

The output is routed to the input of the network analyzer via 50 Ω coax. For 2 k load, 37.9 dB is added to the measurement to refer back to the amplifier's output per [Table 5](#).

For output impedance, the signal is injected at V_{OUT} with V_{IN} left open. The voltage drop across the 2x R_O resistors is measured with a high impedance differential probe and used to calculate the impedance seen looking into the amplifier's output.

9.1.2 Distortion

At 1 MHz and above, the circuit shown in [Figure 68](#) is used to measure harmonic, intermodulation distortion, and output impedance of the amplifier.

A signal generator is used as the signal source and the output is measured with a spectrum analyzer. The output impedance of the signal generator is 50 Ω and is AC coupled. R_{IT} and R_G are chosen to impedance match to 50 Ω and maintain the proper gain. To balance the amplifier, a 0.22 μ F cap and 49.9 Ω resistor to ground is inserted across R_{IT} on the alternate input. A low-pass filter is inserted in series with the input to reduce harmonics generated at the signal source. The level of the fundamental is measured and then a high-pass filter is inserted at the output to reduce the fundamental so it does not generate distortion in the input of the spectrum analyzer.

Distortion in the audio band is measured using an audio analyzer. Refer to audio measurement section for detail.

9.1.3 Slew Rate, Transient Response, Settling Time, Overdrive, Output Voltage, and Turn-On and Turn-Off Time

The circuit shown in [Figure 69](#) is used to measure slew rate, transient response, settling time, overdrive recovery, and output voltage swing. Turn-on and turn-off times are measured with 50 Ω input termination on the \overline{PD} input, by replacing the 0.22 μ F capacitor with 49.9 Ω resistor.

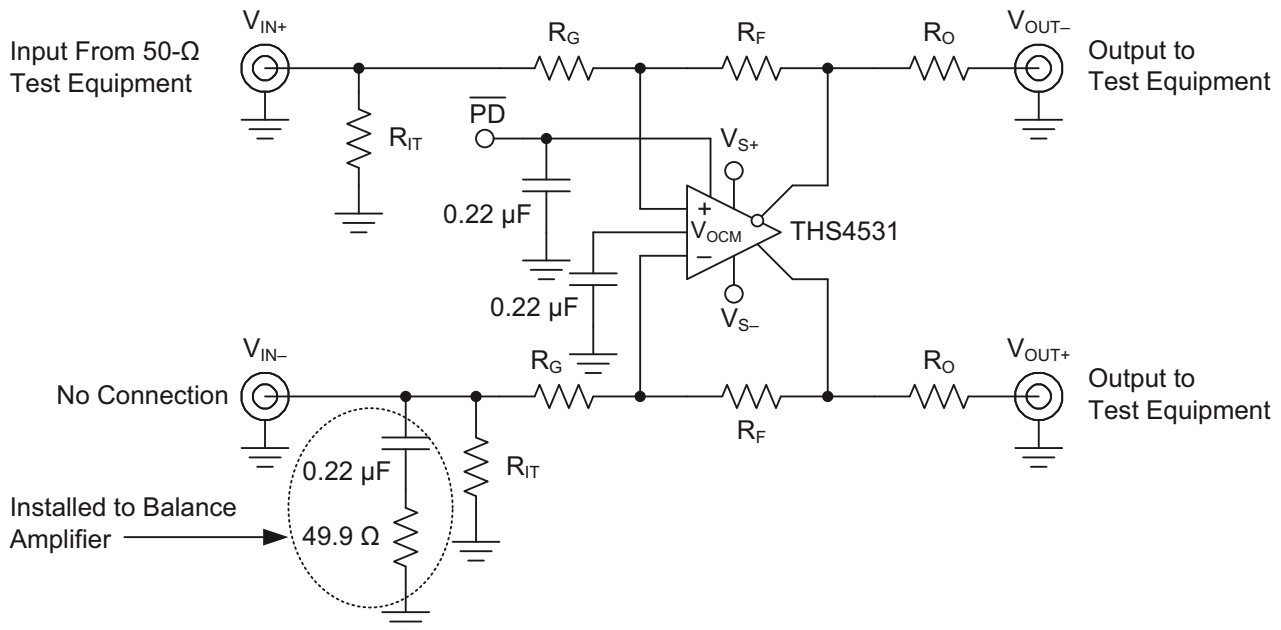

Figure 69. Slew Rate, Transient Response, Settling Time, Z_O , Overdrive Recovery, V_{OUT} Swing, and Turn-On and Trun-Off Test Circuit

9.1.4 Common-Mode and Power Supply Rejection

The circuit shown in Figure 70 is used to measure the CMRR. The signal from the network analyzer is applied common-mode to the input.

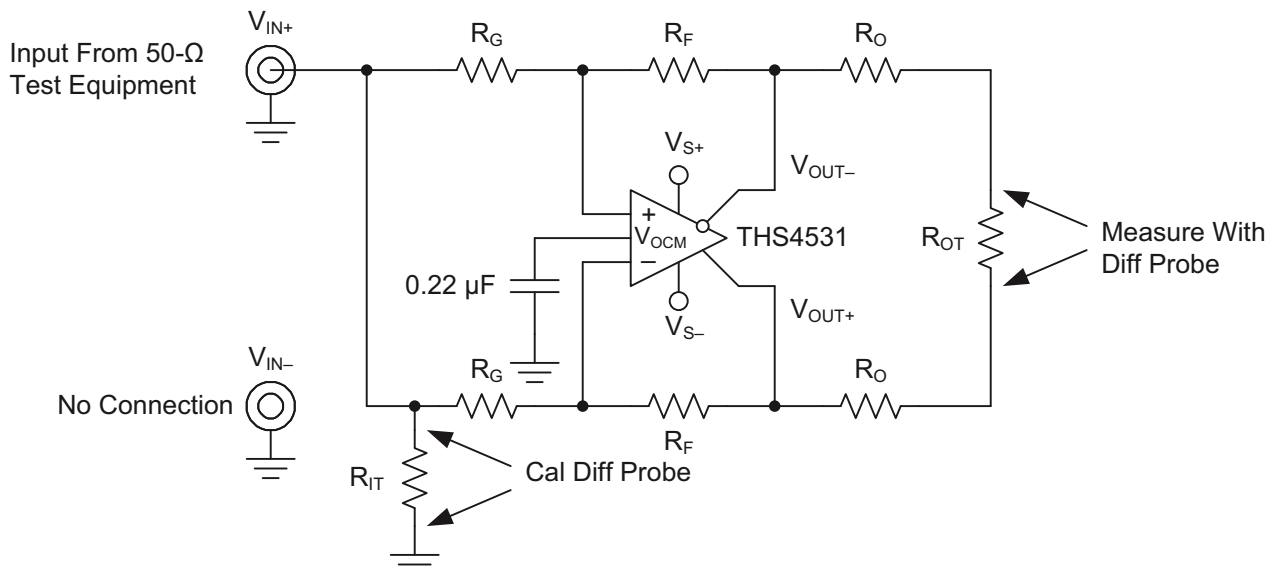

Figure 70. CMRR Test Circuit

Figure 71 is used to measure the PSRR of V_{S+} and V_{S-} . The power supply is applied to the network analyzer's DC offset input. For both CMRR and PSRR, the output is probed using a high impedance differential probe across R_{OT} .

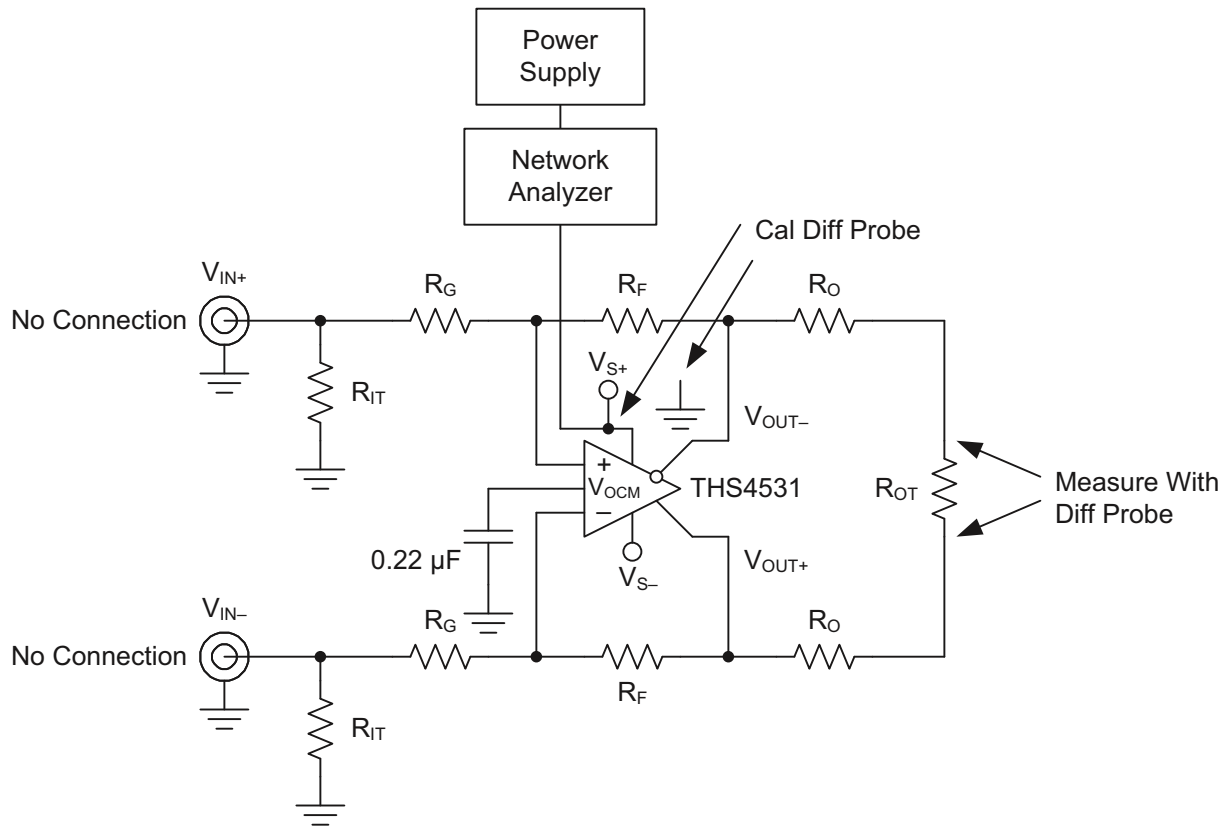

Figure 71. PSRR Test Circuit

9.1.5 V_{OCM} Input

The circuit shown in Figure 72 is used to measure the transient response, frequency response and input impedance of the V_{OCM} input. For these tests, the cal point is across the 49.9 Ω V_{OCM} termination resistor. Transient response and frequency response are measured with R_{CM} = 0 Ω and using a high impedance differential probe at the summing junction of the two R_O resistors, with respect to ground. The input impedance is measured using a high impedance differential probe at the V_{OCM} pin and the drop across R_{CM} is used to calculate the impedance seen looking into the amplifier's V_{OCM} input.

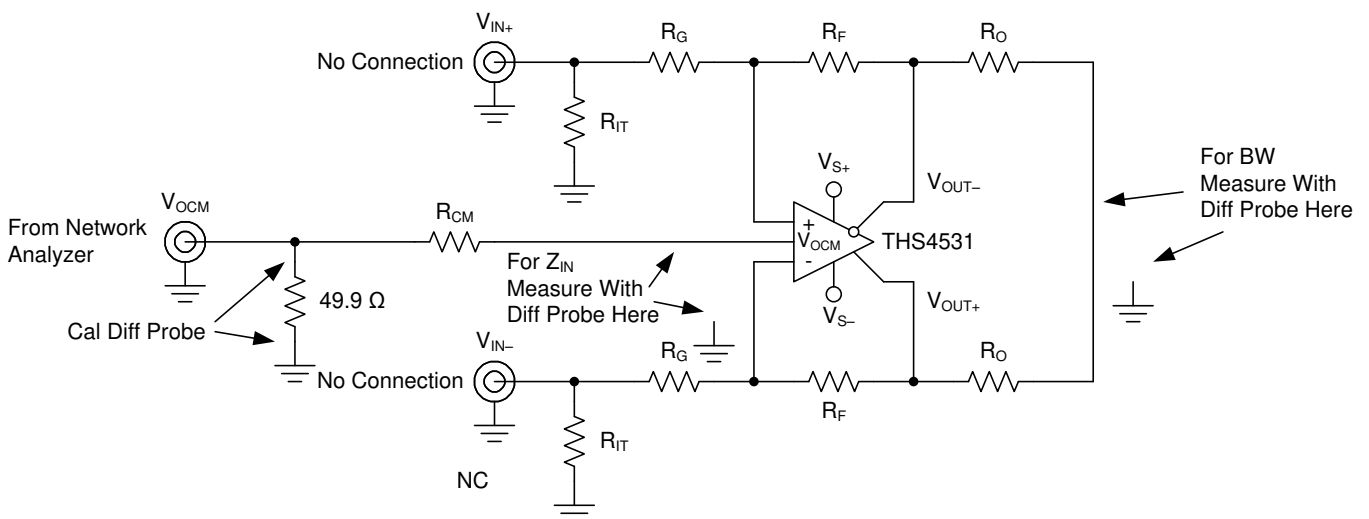

Figure 72. V_{OCM} Input Test Circuit

9.1.6 Balance Error

The circuit shown in Figure 73 is used to measure the balance error of the main differential amplifier. A network analyzer is used as the signal source and the measurement device. The output impedance of the network analyzer is 50 Ω and is DC coupled. R_{IT} and R_G are chosen to impedance match to 50 Ω and maintain the proper gain. To balance the amplifier, a 49.9 Ω resistor to ground is inserted across R_{IT} on the alternate input. The output is measured using a high impedance differential probe at the summing junction of the two R_O resistors, with respect to ground.

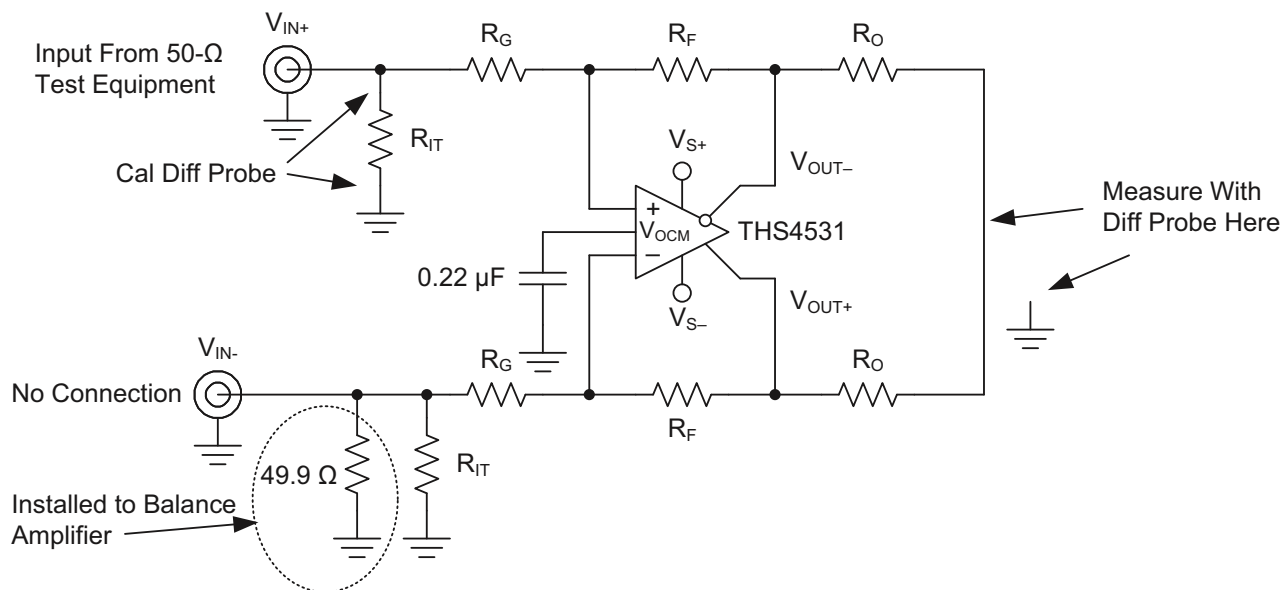

Figure 73. Balance Error Test Circuit

9.2 Application Circuits

The following circuits show application information for the THS4531. For simplicity, power supply decoupling capacitors are not shown in these diagrams – please see the EVM and Layout Recommendations section for recommendations. For more detail on the use and operation of fully differential op amps refer to application report *Fully-Differential Amplifiers* [SLOA054D](#).

9.2.1 Differential Input to Differential Output Amplifier

The THS4531 is a fully differential op amp and can be used to amplify differential input signals to differential output signals. A basic block diagram of the circuit is shown in [Figure 74](#) (V_{OCM} and PD inputs not shown). The gain of the circuit is set by R_F divided by R_G .

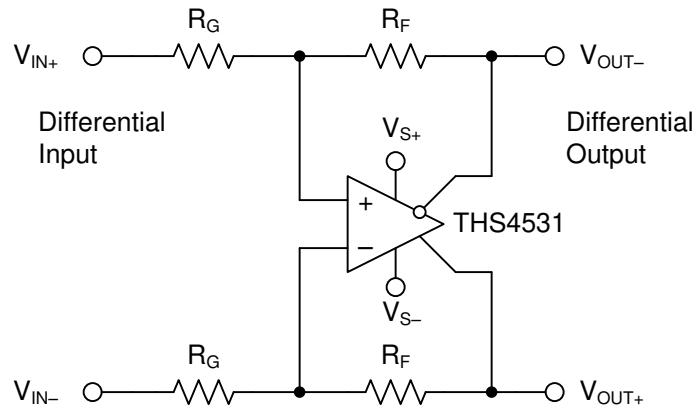

Figure 74. Differential Input to Differential Output Amplifier

9.2.2 Single-Ended Input to Differential Output Amplifier

The THS4531 can also be used to amplify and convert single-ended input signals to differential output signals. A basic block diagram of the circuit is shown in [Figure 75](#) (V_{OCM} and PD inputs not shown). The gain of the circuit is again set by R_F divided by R_G .

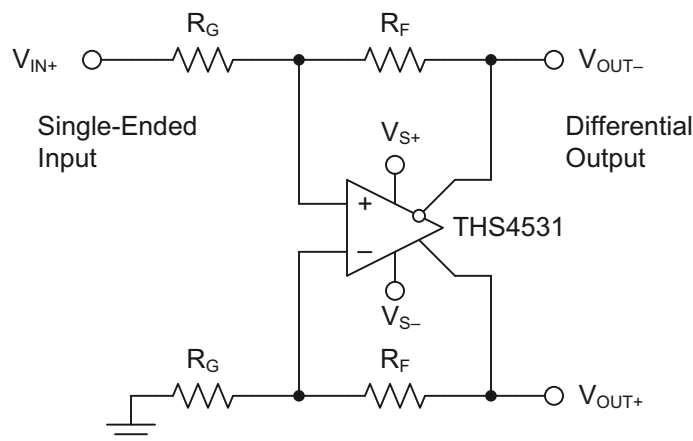

Figure 75. Single-Ended Input to Differential Output Amplifier

9.2.3 Differential Input to Single-Ended Output Amplifier

Fully differential op amps like the THS4531 are not recommended for differential to single-ended conversion. This application is best performed with an instrumentation amplifier or with a standard op amp configured as a classic differential amplifier. See application section of the OPA835 data sheet ([SLOS713](#)).

Application Circuits (continued)

9.2.4 Input Common-Mode Voltage Range

The input common-mode voltage of a fully differential op amp is the voltage at the + and – input pins of the op amp.

It is important to not violate the input common-mode voltage range (V_{ICR}) of the op amp. Assuming the op amp is in linear operation the voltage across the input pins is only a few millivolts at most. So finding the voltage at one input pin will determine the input common-mode voltage of the op amp.

Treating the negative input as a summing node, the voltage is given by:

$$\left(V_{OUT+} \times \frac{R_G}{R_G + R_F} \right) + \left(V_{IN-} \times \frac{R_F}{R_G + R_F} \right) \quad (1)$$

To determine the V_{ICR} of the op amp, the voltage at the negative input is evaluated at the extremes of V_{OUT+} .

As the gain of the op amp increases, the input common-mode voltage becomes closer and closer to the input common-mode voltage of the source.

9.2.5 Setting the Output Common-Mode Voltage

The output common-mode voltage is set by the voltage at the V_{OCM} pin and the internal circuit works to maintain the output common-mode voltage as close as possible to this voltage. If left unconnected, the output common-mode is set to mid-supply by internal circuitry, which may be over-driven from an external source. Figure 76 is representative of the V_{OCM} input. The internal V_{OCM} circuit has about 24 MHz of -3 dB bandwidth, which is required for best performance, but it is intended to be a DC bias input pin. Bypass capacitors are recommended on this pin to reduce noise. The external current required to overdrive the internal resistor divider is given approximately by the formula:

$$I_{EXT} = \frac{2V_{OCM} - (V_{S+} - V_{S-})}{1.25 \text{ M}\Omega} \quad (2)$$

where V_{OCM} is the voltage applied to the V_{OCM} pin.

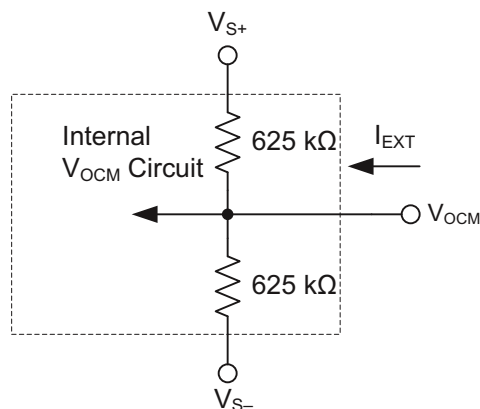

Figure 76. Simplified V_{OCM} Input Circuit

9.2.6 Single-Supply Operation

To facilitate testing with common lab equipment, the THS4531 EVM is built to allow for split-supply operation and most of the data presented in this data sheet was taken with split-supply power inputs. But the device is designed for use with single-supply power operation and can easily be used with single-supply power without degrading the performance. The only requirement is to bias the device properly and the specifications in this data sheet are given for single supply operation.

Application Circuits (continued)

9.2.7 Low Power Applications and the Effects of Resistor Values on Bandwidth

The THS4531 is designed for the nominal value of R_F to be 2 k Ω . This gives excellent distortion performance, maximum bandwidth, best flatness, and best pulse response. It also loads the amplifier. For example, in gain of 1 with $R_F = R_G = 2$ k Ω , R_G to ground, and $V_{OUT+} = 4$ V, 1 mA of current will flow through the feedback path to ground. In low power applications, it is desirable to reduce this current by increasing the gain setting resistors values. Using larger value gain resistors has two primary side effects (other than lower power) due to their interaction with the device and PCB parasitic capacitance:

1. Lowers the bandwidth.
2. Lowers the phase margin
 - a. This will cause peaking in the frequency response.
 - b. And will cause over shoot and ringing in the pulse response.

Figure 77 shows the small signal frequency response for gain of 1 with R_F and R_G equal to 2 k Ω , 10 k Ω , and 100 k Ω . The test was done with $R_L = 2$ k Ω . Due to loading effects of R_L , lower values may reduce the peaking, but higher values will not have a significant effect.

As expected, larger value gain resistors cause lower bandwidth and peaking in the response (peaking in frequency response is synonymous with overshoot and ringing in pulse response).

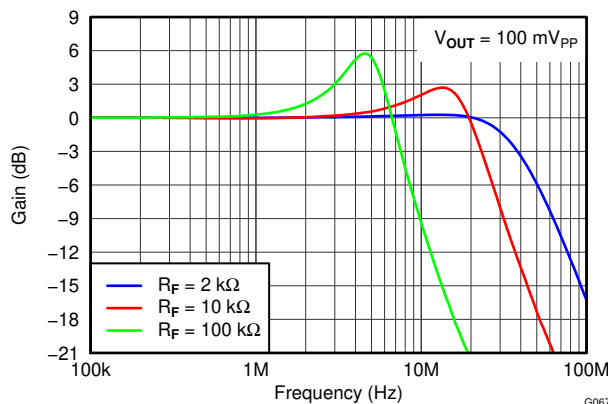

Figure 77. THS4531 Frequency Response with Various Gain Setting Resistor Values

9.2.8 Driving Capacitive Loads

The THS4531 is designed for a nominal capacitive load of 2 pF (differentially). When driving capacitive loads greater than this, it is recommended to use small resistors (R_O) in series with the output as close to the device as possible. Without R_O , capacitance on the output will interact with the output impedance of the amplifier causing phase shift in the loop gain of the amplifier that will reduce the phase margin resulting in:

1. Peaking in the frequency response.
2. Overshoot, undershoot, and ringing in the time domain response with a pulse or square-wave signal.
3. May lead to instability or oscillation.

Inserting R_O will compensate the phase shift and restore the phase margin, but it will also limit bandwidth. The circuit shown in Figure 69 is used to test for best R_O versus capacitive loads, C_L , with a capacitance placed differential across the V_{OUT+} and V_{OUT-} along with 2 k Ω load resistor, and the output is measure with a differential probe. Figure 78 shows the optimum values of R_O versus capacitive loads, C_L , and Figure 79 shows the frequency response with various values. Performance is the same on both 2.7 V and 5 V supply.

Application Circuits (continued)

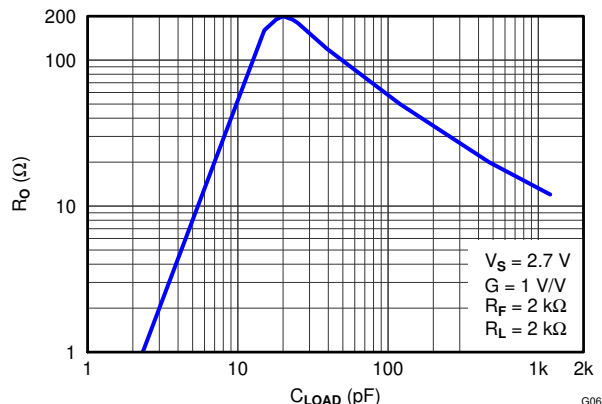

Figure 78. Recommended Series Output Resistor vs Capacitive Load for Flat Frequency Response

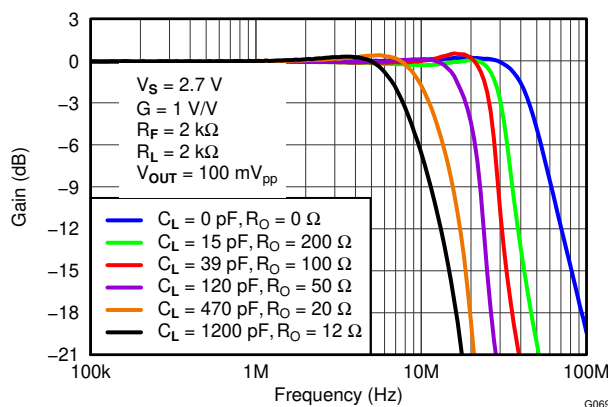

Figure 79. Frequency Response for Various R_O and C_L Values

9.2.9 Audio Performance

The THS4531 provides excellent audio performance with very low quiescent power. To show performance in the audio band, the device was tested with an audio analyzer. THD+N and FFT tests were run at 1 V_{rms} output voltage. Performance is the same on both 2.7 V and 5 V supply. Figure 80 is the test circuit used, and Figure 81 and Figure 82 show performance of the analyzer. In the FFT plot the harmonic spurs are at the testing limit of the analyzer, which means the THS4531 is actually much better than can be directly measured. Because the THS4531 distortion performance cannot be directly measured in the audio band it is estimated from measurement in high noise gain configuration correlated with simulation.

Application Circuits (continued)

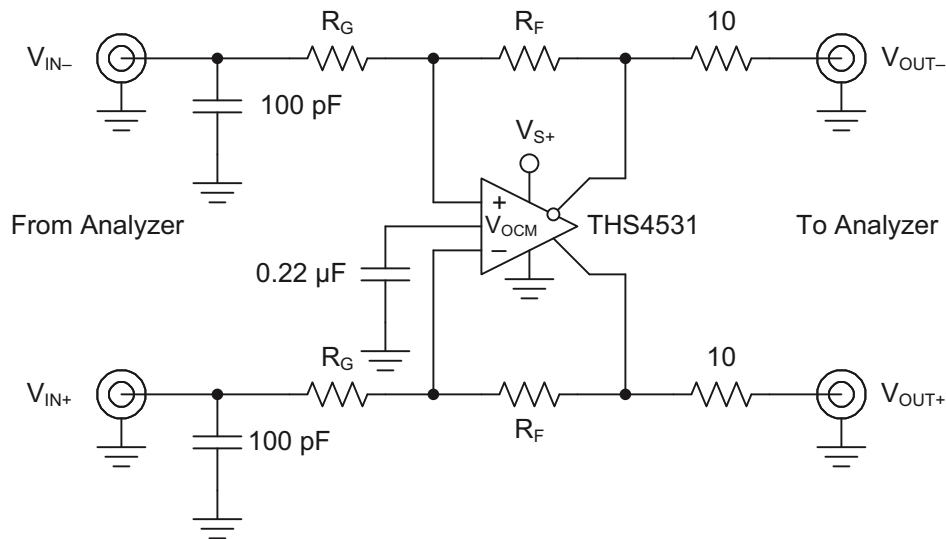

Figure 80. THS4531 Audio Analyzer Test Circuit

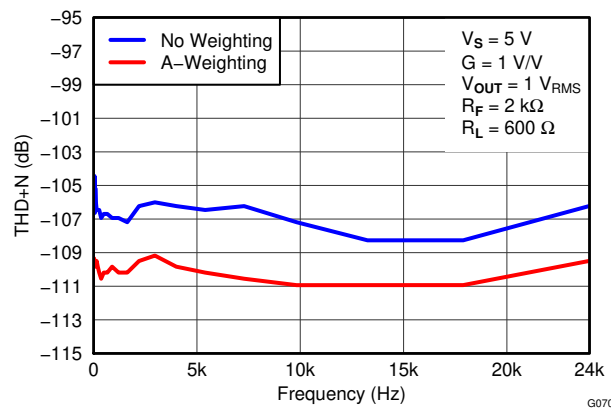

Figure 81. THD+N on Audio Analyzer, 10 Hz to 24 kHz

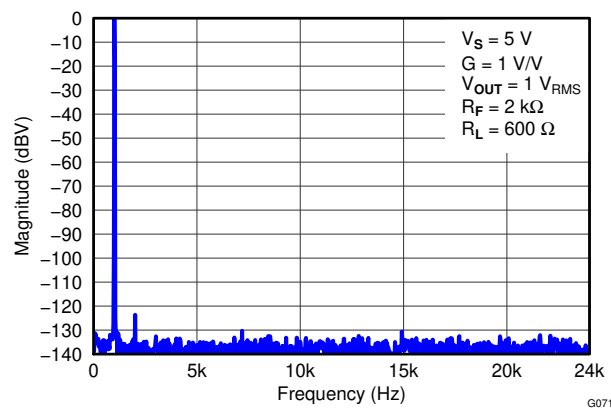

Figure 82. 1 kHz FFT Plot on Audio Analyzer

Application Circuits (continued)

9.2.10 Audio On and Off Pop Performance

The THS4531 is tested to show on and off pop performance by connecting a speaker between the differential outputs and switching on and off the power supply, and also by using the power down function of the THS4531. Testing was done with and without tones. During these tests no audible pop could be heard.

With no input tone, [Figure 83](#) shows the voltage waveforms when switching power on to the THS4531 and [Figure 84](#) shows voltage waveforms when turning power off. The transients during power on and off show no audible pop should be heard.

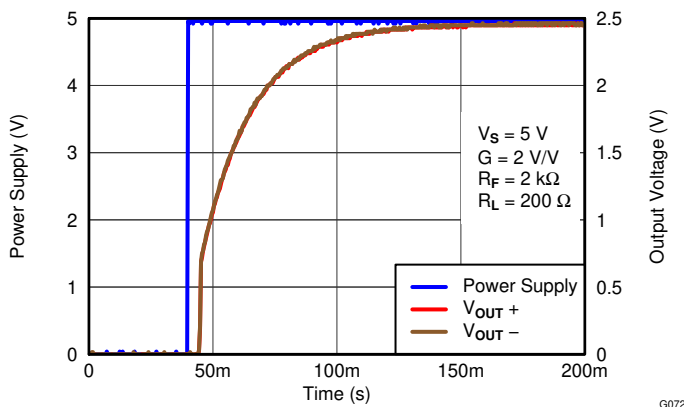

Figure 83. Power Supply Turn On Pop Performance

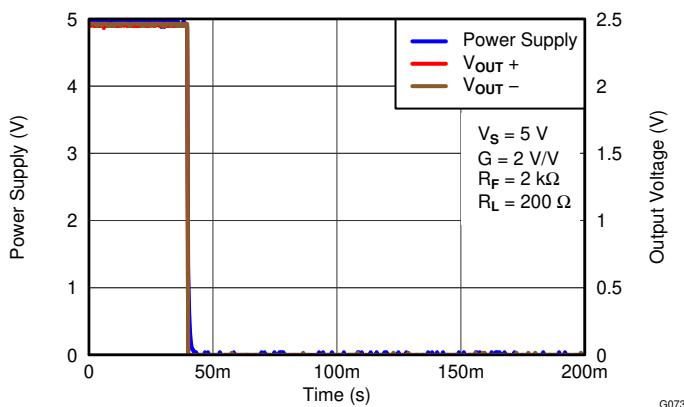

Figure 84. Power Supply Turn Off Pop Performance

With no input tone, [Figure 85](#) shows the voltage waveforms using the $\overline{\text{PD}}$ pin to enable and disable the THS4531. The transients during power on and off show no audible pop should be heard.

Application Circuits (continued)

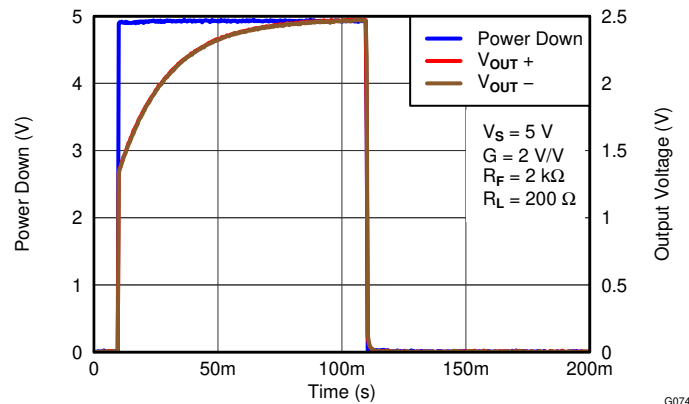

Figure 85. $\overline{\text{PD}}$ Enable Pop Performance

9.3 Audio ADC Driver Performance: THS4531 AND PCM4204 Combined Performance

To show achievable performance with a high performance audio ADC, the THS4531 is tested as the drive amplifier for the PCM4204. The PCM4204 is a high-performance, four-channel analog-to-digital (A/D) converter designed for professional and broadcast audio applications. The PCM4204 architecture utilizes a 1-bit delta-sigma modulator per channel incorporating an advanced dither scheme for improved dynamic performance, and supports PCM output data. The PCM4204 provides flexible serial port interface and many other advanced features. Please refer to its data sheet for more information.

The PCM4204 EVM is used to test the audio performance of the THS4531 as a drive amplifier. The standard PCM4204 EVM is provided with 4x OPA1632 fully differential amplifiers, which use the same pin out as the THS4531. For testing, one of these amplifiers is replaced with a THS4531 device in same package (MSOP), gain changed to 1 V/V, and power supply changed to single supply +5 V. Figure 86 shows the circuit. With single supply +5 V supply the output common-mode of the THS4531 defaults to +2.5 V as required at the input of the PCM4204. So the resistor connecting the V_{OCM} input of the THS4531 to the input common-mode drive from the PCM4204 is optional and no performance change was noted with it connected or removed. The EVM power connections were modified by connecting positive supply inputs, +15 V, +5 VA and +5 VD, to a +5 V external power supply (EXT +3.3 was not used) and connecting -15 V and all ground inputs to ground on the external power supply so only one external +5 V supply was needed to power all devices on the EVM.

Audio ADC Driver Performance: THS4531 AND PCM4204 Combined Performance (continued)

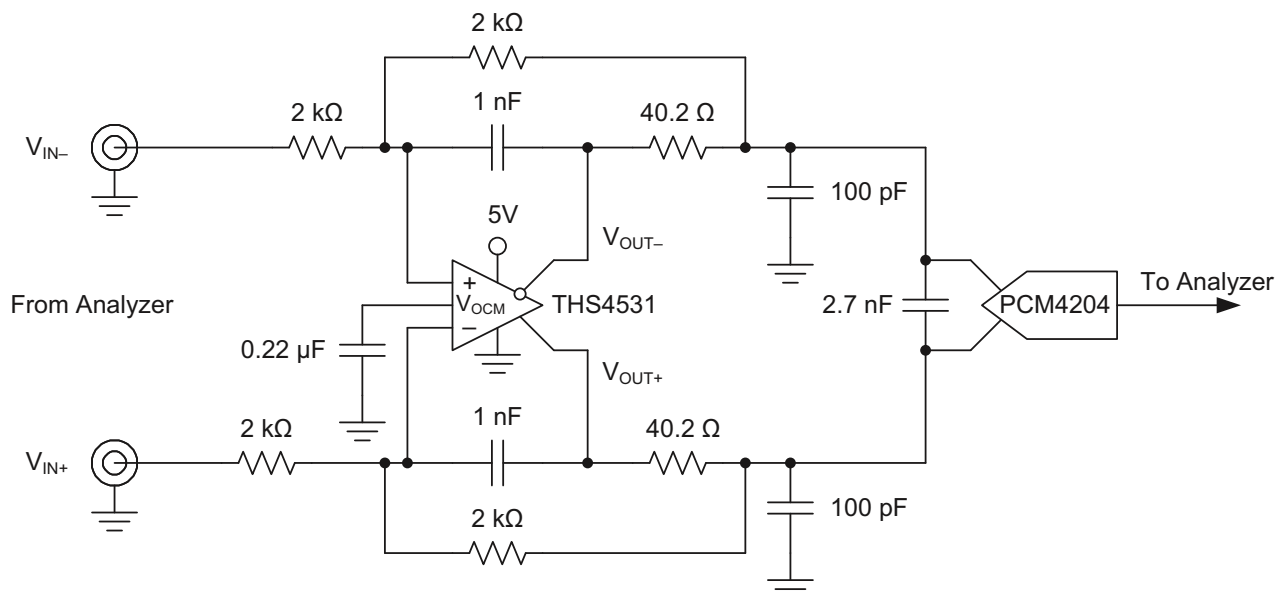

Figure 86. THS4531 and PCM4204 Test Circuit

An audio analyzer is used to provide an analog audio input to the EVM and the PCM formatted digital output is read by the digital input on the analyzer. Data was taken at $f_s = 96$ kHz, and audio output uses PCM format. Other data rates and formats are expected to show similar performance in line with that shown in the data sheet.

Figure 87 shows the THD+N vs Frequency with no weighting and Figure 88 shows an FFT with 1 kHz input tone. Input signal to the PCM4204 for these tests is -0.5 dBFS. Table 6 summarizes results of testing using the THS4531 + PCM4204 versus typical Data Sheet performance, and show it make an excellent drive amplifier for this ADC.

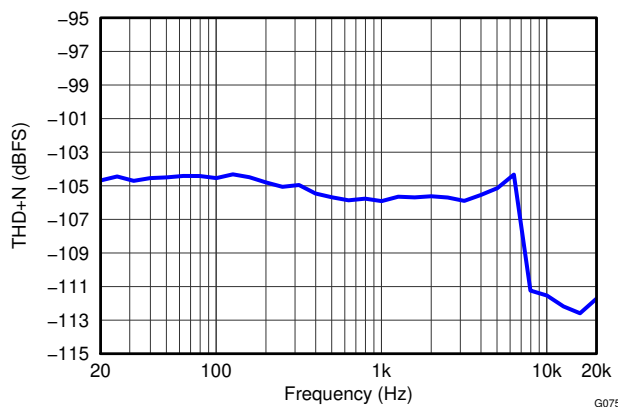

Figure 87. THS4531 + PCM4204 THD+N vs Frequency with No Weighting

Audio ADC Driver Performance: THS4531 AND PCM4204 Combined Performance (continued)

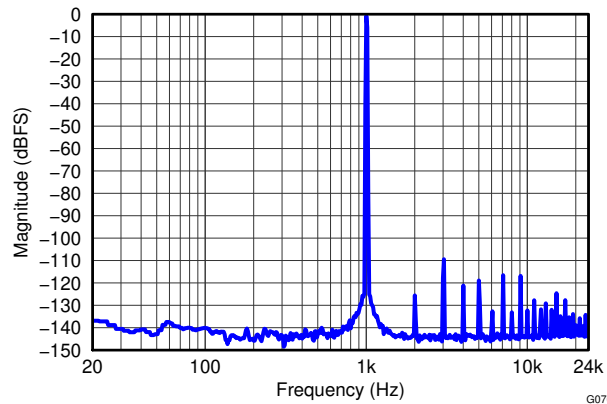

Figure 88. THS4531 + PCM4204 1 kHz FFT

Table 6. 1 kHz AC Analysis: Test Circuit versus PCM4204 Data Sheet Typical Specifications ($f_s = 96$ kSPS)

CONFIGURATION	STONE	THD + N
THS4531 + PCM4204	1 kHz	-106 dB
PCM4204 data sheet (typical)	1 kHz	-103 dB

9.4 SAR ADC Performance

9.4.1 THS4531 and ADS8321 Combined Performance

To show achievable performance with a high performance SAR ADC, the THS4531 is tested as the drive amplifier for the ADS8321. The ADS8321 is a 16-bit, SAR ADC that offers excellent AC and DC performance, with ultra-low power and small size. The circuit shown in Figure 89 is used to test the performance. Data was taken using the ADS8321 at 100 kSPS with input frequency of 10 kHz and signal levels 0.5 dB below full scale. The FFT plot of the spectral performance is in Figure 90. A summary of the FFT analysis results are in Table 7 along with ADS8321 typical data sheet performance at $f_s = 100$ kSPS. Please refer to its data sheet for more information.

The standard ADS8321 EVM and THS4531 EVM are modified to implement the schematic in Figure 89 and used to test the performance of the THS4531 as a drive amplifier. With single supply +5 V supply the output common-mode of the THS4531 defaults to +2.5 V as required at the input of the ADS8321 so the V_{OCM} input of the THS4531 simply bypassed to GND with 0.22 μ F capacitor. The summary of results of the FFT analysis versus typical data sheet performance shown in Table 7 show the THS4531 will make an excellent drive amplifier for this ADC.

SAR ADC Performance (continued)

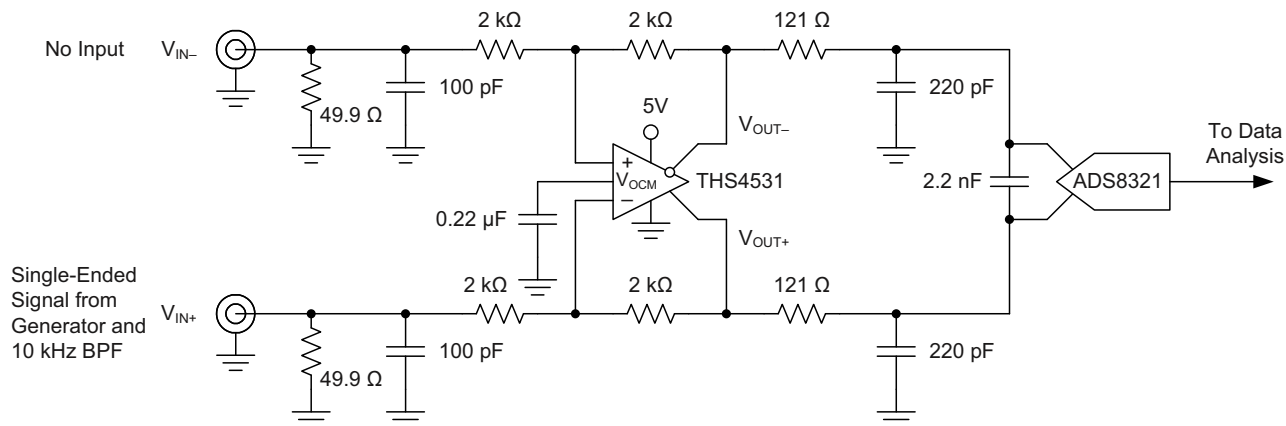

Figure 89. THS4531 and ADS8321 Test Circuit

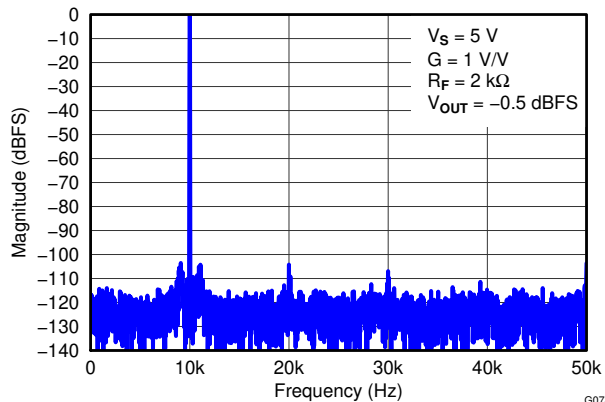

Figure 90. THS4531 + ADS8321 1-kHz FFT

Table 7. 10 kHz FFT Analysis Summary

CONFIGURATION	TONE	SIGNAL	SNR	THD	SINAD	SFDR
THS4531 + ADS8321	10 kHz	-0.5 dBFS	87 dBc	-96 dBc	87 dBc	100 dBc
ADS8321 data sheet (typical)	10 kHz	-0.5 dBFS	87 dBc	-86 dBc	84 dBc	86 dBc

9.4.2 THS4531 and ADS7945 Combined Performance

To show achievable performance with a high performance SAR ADC, the THS4531 is tested as the drive amplifier for the ADS7945. The ADS7945 is a 14-bit, SAR ADC that offers excellent AC and DC performance, with low power and small size. The circuit shown in Figure 91 is used to test the performance. Data was taken using the ADS7945 at 2MSPS with input frequency of 10 kHz and signal level 0.5 dB below full scale. The FFT plot of the spectral performance is in Figure 92. A summary of the FFT analysis results are in Table 8 along with ADS7945 typical data sheet performance at $f_s = 2$ MSPS. Please refer to its data sheet for more information.

The standard ADS7945 EVM and THS4531 EVM are modified to implement the schematic in Figure 91 and used to test the performance of the THS4531 as a drive amplifier. With single supply +5 V supply the output common-mode of the THS4531 defaults to +2.5 V as required at the input of the ADS7945 so the V_{OCM} input of the THS4531 simply bypassed to GND with 0.22 μ F capacitor. The summary of results of the FFT analysis versus typical data sheet performance shown in Table 8 show the THS4531 will make an excellent drive amplifier for this ADC.

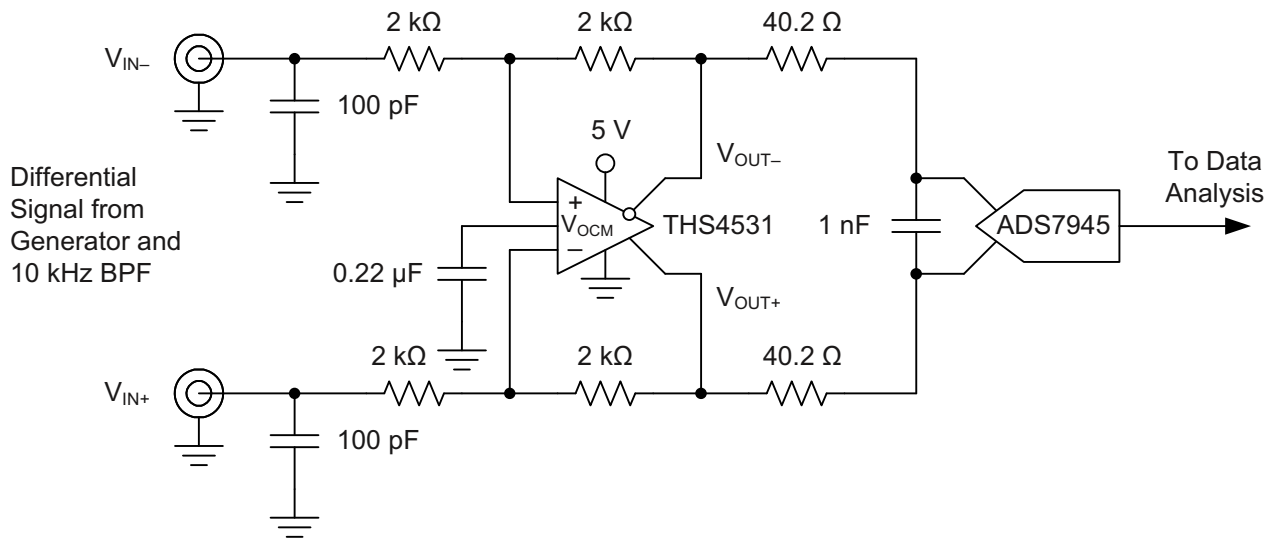

Figure 91. THS4531 and ADS7945 Test Circuit

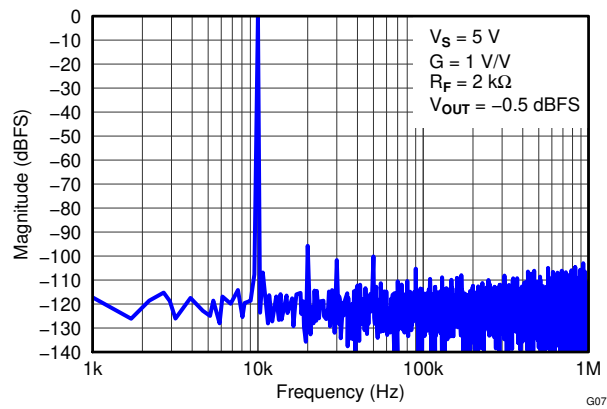

Figure 92. THS4531 and ADS7945 Test Circuit

Table 8. 10 kHz FFT Analysis Summary

CONFIGURATION	TONE	SIGNAL	SNR	THD	SFDR
THS4531 + ADS7945	10 kHz	-0.5 dBFS	83 dBc	-93 dBc	96 dBc
ADS7945 Data sheet (typical)	10 kHz	-0.5 dBFS	84 dBc	-92 dBc	94 dBc

9.5 EVM and Layout Recommendations

The THS4531 EVM ([SLOU334](#)) should be used as a reference when designing the circuit board. It is recommended to follow the EVM layout of the external components near to the amplifier, ground plane construction, and power routing as closely as possible. General guidelines are:

1. Signal routing should be direct and as short as possible into and out of the op amp.
2. The feedback path should be short and direct avoiding vias if possible.
3. Ground or power planes should be removed from directly under the amplifier's input and output pins.
4. A series output resistor is recommended to be placed as near to the output pin as possible. See [Figure 78 Recommended Series Output Resistor vs. Capacitive Load](#) for recommended values given expected capacitive load of design.
5. A 2.2 μF power supply decoupling capacitor should be placed within 2 inches of the device and can be shared with other op amps. For split supply, a capacitor is required for both supplies.
6. A 0.1 μF power supply decoupling capacitor should be placed as near to the power supply pins as possible. Preferably within 0.1 inch. For split supply, a capacitor is required for both supplies.
7. The $\overline{\text{PD}}$ pin uses TTL logic levels referenced to the negative supply voltage ($V_{\text{S-}}$). When not used it should be tied to the positive supply to enable the amplifier. When used, it must be actively driven high or low and should not be left in an indeterminate logic state. A bypass capacitor is not required, but can be used for robustness in noisy environments.

10 Device and Documentation Support

10.1 Device Support

10.1.1 Third-Party Products Disclaimer

TI'S PUBLICATION OF INFORMATION REGARDING THIRD-PARTY PRODUCTS OR SERVICES DOES NOT CONSTITUTE AN ENDORSEMENT REGARDING THE SUITABILITY OF SUCH PRODUCTS OR SERVICES OR A WARRANTY, REPRESENTATION OR ENDORSEMENT OF SUCH PRODUCTS OR SERVICES, EITHER ALONE OR IN COMBINATION WITH ANY TI PRODUCT OR SERVICE.

10.2 Documentation Support

For related documentation see the following:

- *ADS7945 and ADS7946 14-Bit, 2 MSPS, Dual-Channel, Differential/Single-Ended, Ultra low-Power Analog-to-Digital Converters*, [SBAS539](#)
- *ADS8321 16-Bit, High Speed, Micro Power Sampling Analog-to-Digital converter*, [SBAS123](#)
- *Extending Rail-to-Rail Output Range for Fully Differential Amplifiers to Include True Zero Volts*, [TIDU187](#)
- *Fully-Differential Amplifiers*, [SLOA054](#)
- *OPAx835 Ultra Low-Power, Rail-to-Rail Out, Negative Rail In, VFB Op Amp*, [SLOS713](#)
- *PCM4204 High-Performance 24-Bit, 216 kHz Sampling Four-Channel Audio Analog-to-Digital Converter*, [SBAS327](#)
- *SN74AVC1T45 Single-Bit Dual-Supply Bus Transceiver with Configurable Voltage Translation and 3-State Outputs*, [SCES530](#)
- *THS4531ADGKEVM Evaluation Module*, [SLOU356](#)

10.3 Community Resources

[TI E2E™ support forums](#) are an engineer's go-to source for fast, verified answers and design help — straight from the experts. Search existing answers or ask your own question to get the quick design help you need.

Linked content is provided "AS IS" by the respective contributors. They do not constitute TI specifications and do not necessarily reflect TI's views; see TI's [Terms of Use](#).

10.4 Trademarks

E2E is a trademark of Texas Instruments.

All other trademarks are the property of their respective owners.

10.5 Electrostatic Discharge Caution



These devices have limited built-in ESD protection. The leads should be shorted together or the device placed in conductive foam during storage or handling to prevent electrostatic damage to the MOS gates.

10.6 Glossary

[SLYZ022](#) — *TI Glossary*.

This glossary lists and explains terms, acronyms, and definitions.

11 Mechanical, Packaging, and Orderable Information

The following pages include mechanical, packaging, and orderable information. This information is the most current data available for the designated devices. This data is subject to change without notice and revision of this document. For browser-based versions of this data sheet, refer to the left-hand navigation.

PACKAGING INFORMATION

Orderable Device	Status (1)	Package Type	Package Drawing	Pins	Package Qty	Eco Plan (2)	Lead finish/ Ball material (6)	MSL Peak Temp (3)	Op Temp (°C)	Device Marking (4/5)	Samples
THS4531ID	ACTIVE	SOIC	D	8	75	RoHS & Green	NIPDAU	Level-2-260C-1 YEAR	-40 to 125	T4531	Samples
THS4531IDGK	ACTIVE	VSSOP	DGK	8	80	RoHS & Green	NIPDAUAG	Level-2-260C-1 YEAR	-40 to 125	4531	Samples
THS4531IDGKR	ACTIVE	VSSOP	DGK	8	2500	RoHS & Green	NIPDAUAG	Level-2-260C-1 YEAR	-40 to 125	4531	Samples
THS4531IDR	ACTIVE	SOIC	D	8	2500	RoHS & Green	NIPDAU	Level-2-260C-1 YEAR	-40 to 125	T4531	Samples
THS4531IRUNR	ACTIVE	QFN	RUN	10	3000	RoHS & Green	NIPDAU	Level-2-260C-1 YEAR	-40 to 125	4531	Samples
THS4531IRUNT	ACTIVE	QFN	RUN	10	250	RoHS & Green	NIPDAU	Level-2-260C-1 YEAR	-40 to 125	4531	Samples

(1) The marketing status values are defined as follows:

ACTIVE: Product device recommended for new designs.

LIFEBUY: TI has announced that the device will be discontinued, and a lifetime-buy period is in effect.

NRND: Not recommended for new designs. Device is in production to support existing customers, but TI does not recommend using this part in a new design.

PREVIEW: Device has been announced but is not in production. Samples may or may not be available.

OBSOLETE: TI has discontinued the production of the device.

(2) **RoHS:** TI defines "RoHS" to mean semiconductor products that are compliant with the current EU RoHS requirements for all 10 RoHS substances, including the requirement that RoHS substance do not exceed 0.1% by weight in homogeneous materials. Where designed to be soldered at high temperatures, "RoHS" products are suitable for use in specified lead-free processes. TI may reference these types of products as "Pb-Free".

RoHS Exempt: TI defines "RoHS Exempt" to mean products that contain lead but are compliant with EU RoHS pursuant to a specific EU RoHS exemption.

Green: TI defines "Green" to mean the content of Chlorine (Cl) and Bromine (Br) based flame retardants meet JS709B low halogen requirements of <=1000ppm threshold. Antimony trioxide based flame retardants must also meet the <=1000ppm threshold requirement.

(3) MSL, Peak Temp. - The Moisture Sensitivity Level rating according to the JEDEC industry standard classifications, and peak solder temperature.

(4) There may be additional marking, which relates to the logo, the lot trace code information, or the environmental category on the device.

(5) Multiple Device Markings will be inside parentheses. Only one Device Marking contained in parentheses and separated by a "~" will appear on a device. If a line is indented then it is a continuation of the previous line and the two combined represent the entire Device Marking for that device.

(6) Lead finish/Ball material - Orderable Devices may have multiple material finish options. Finish options are separated by a vertical ruled line. Lead finish/Ball material values may wrap to two lines if the finish value exceeds the maximum column width.

Important Information and Disclaimer: The information provided on this page represents TI's knowledge and belief as of the date that it is provided. TI bases its knowledge and belief on information provided by third parties, and makes no representation or warranty as to the accuracy of such information. Efforts are underway to better integrate information from third parties. TI has taken and continues to take reasonable steps to provide representative and accurate information but may not have conducted destructive testing or chemical analysis on incoming materials and chemicals. TI and TI suppliers consider certain information to be proprietary, and thus CAS numbers and other limited information may not be available for release.

In no event shall TI's liability arising out of such information exceed the total purchase price of the TI part(s) at issue in this document sold by TI to Customer on an annual basis.

TAPE AND REEL INFORMATION

QUADRANT ASSIGNMENTS FOR PIN 1 ORIENTATION IN TAPE

*All dimensions are nominal

Device	Package Type	Package Drawing	Pins	SPQ	Reel Diameter (mm)	Reel Width W1 (mm)	A0 (mm)	B0 (mm)	K0 (mm)	P1 (mm)	W (mm)	Pin1 Quadrant
THS4531IDGKR	VSSOP	DGK	8	2500	330.0	12.4	5.3	3.4	1.4	8.0	12.0	Q1
THS4531IDR	SOIC	D	8	2500	330.0	12.4	6.4	5.2	2.1	8.0	12.0	Q1
THS4531IRUNR	QFN	RUN	10	3000	180.0	8.4	2.3	2.3	1.15	4.0	8.0	Q2
THS4531IRUNT	QFN	RUN	10	250	180.0	8.4	2.3	2.3	1.15	4.0	8.0	Q2

TAPE AND REEL BOX DIMENSIONS

*All dimensions are nominal

Device	Package Type	Package Drawing	Pins	SPQ	Length (mm)	Width (mm)	Height (mm)
THS4531IDGKR	VSSOP	DGK	8	2500	366.0	364.0	50.0
THS4531IDR	SOIC	D	8	2500	340.5	336.1	25.0
THS4531IRUNR	QFN	RUN	10	3000	210.0	185.0	35.0
THS4531IRUNT	QFN	RUN	10	250	210.0	185.0	35.0

TUBE

*All dimensions are nominal

Device	Package Name	Package Type	Pins	SPQ	L (mm)	W (mm)	T (μm)	B (mm)
THS4531ID	D	SOIC	8	75	507	8	3940	4.32
THS4531IDGK	DGK	VSSOP	8	80	330	6.55	500	2.88

DGK (S-PDSO-G8)

PLASTIC SMALL-OUTLINE PACKAGE



- NOTES:
- A. All linear dimensions are in millimeters.
 - B. This drawing is subject to change without notice.
 - C. Body length does not include mold flash, protrusions, or gate burrs. Mold flash, protrusions, or gate burrs shall not exceed 0.15 per end.
 - D. Body width does not include interlead flash. Interlead flash shall not exceed 0.50 per side.
 - E. Falls within JEDEC MO-187 variation AA, except interlead flash.



- NOTES:
- A. All linear dimensions are in millimeters.
 - B. This drawing is subject to change without notice.
 - C. Publication IPC-7351 is recommended for alternate designs.
 - D. Laser cutting apertures with trapezoidal walls and also rounding corners will offer better paste release. Customers should contact their board assembly site for stencil design recommendations. Refer to IPC-7525 for other stencil recommendations.
 - E. Customers should contact their board fabrication site for solder mask tolerances between and around signal pads.

GENERIC PACKAGE VIEW

RUN 10

WQFN - 0.8 mm max height

2 X 2, 0.5 mm pitch

PLASTIC QUAD FLATPACK - NO LEAD

This image is a representation of the package family, actual package may vary.
Refer to the product data sheet for package details.

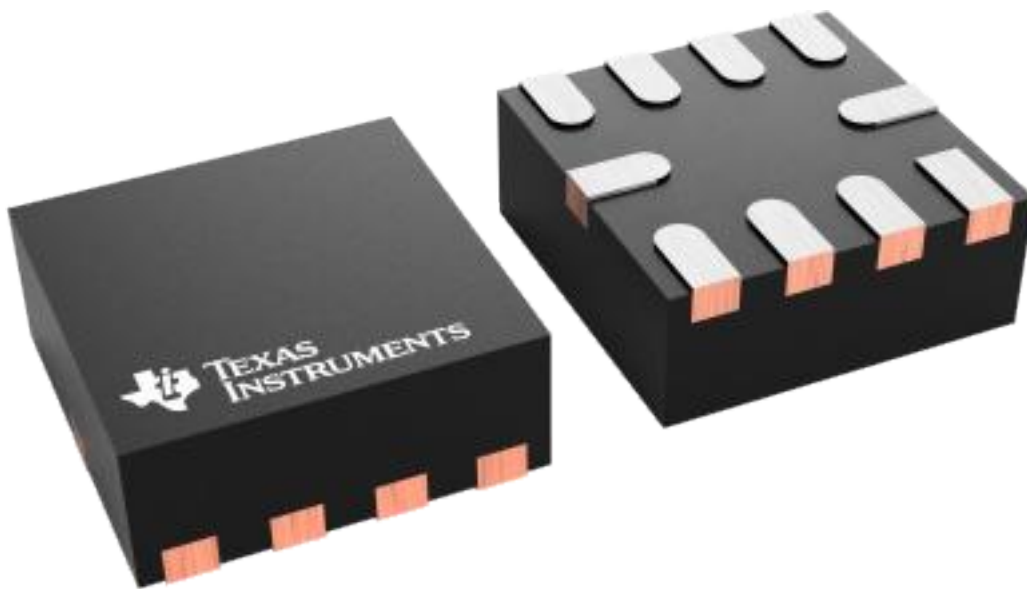

4228249/A

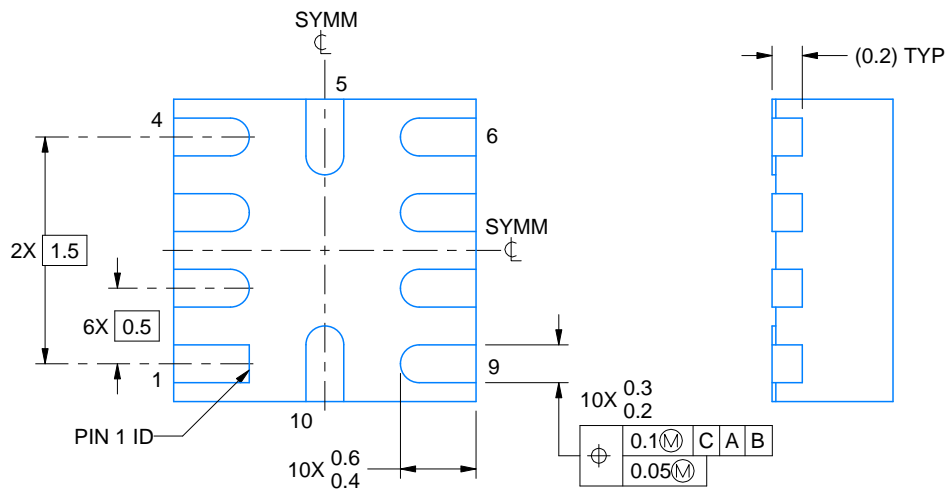
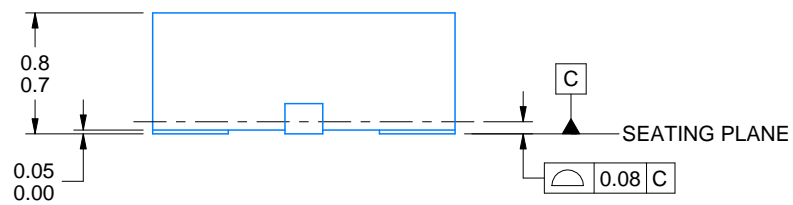
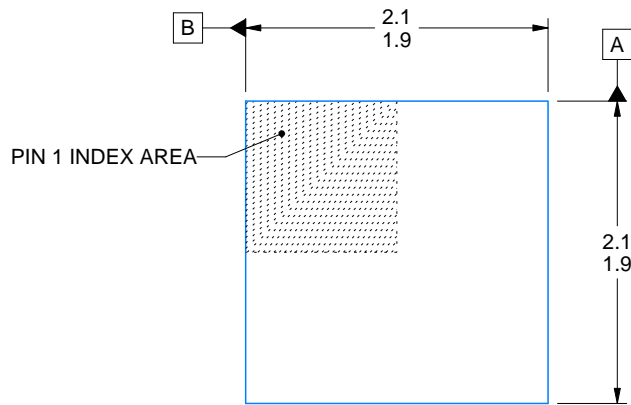
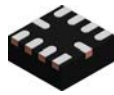

4220470/A 05/2020

NOTES:

1. All linear dimensions are in millimeters. Any dimensions in parenthesis are for reference only. Dimensioning and tolerancing per ASME Y14.5M.
2. This drawing is subject to change without notice.

EXAMPLE BOARD LAYOUT

RUN0010A

WQFN - 0.8 mm max height

PLASTIC QUAD FLATPACK - NO LEAD

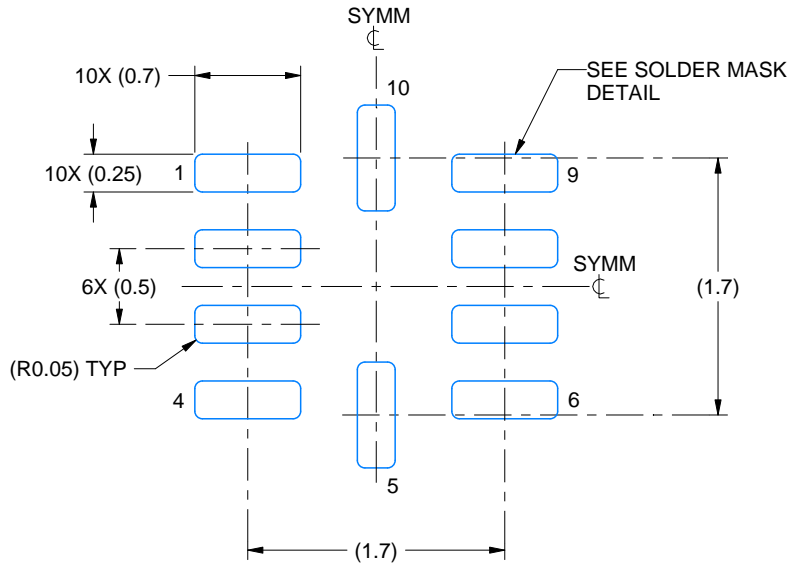

LAND PATTERN EXAMPLE
EXPOSED METAL SHOWN
SCALE: 20X

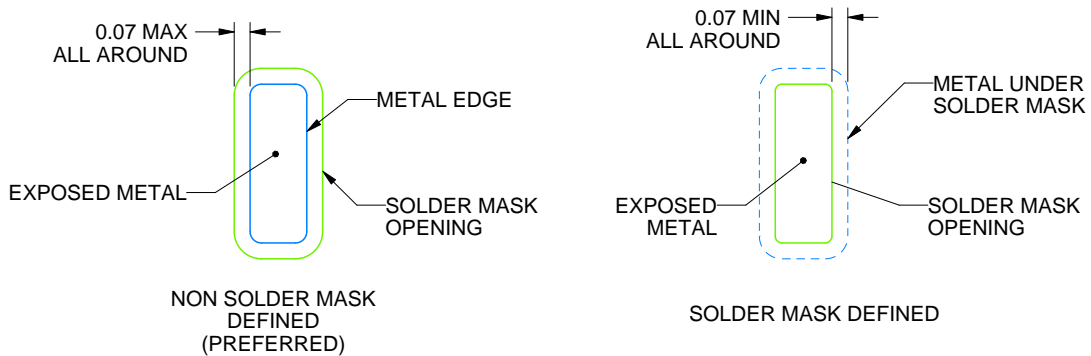

SOLDER MASK DETAILS

4220470/A 05/2020

NOTES: (continued)

- This package is designed to be soldered to a thermal pad on the board. For more information, see Texas Instruments literature number SLUA271 (www.ti.com/lit/slua271).

EXAMPLE STENCIL DESIGN

RUN0010A

WQFN - 0.8 mm max height

PLASTIC QUAD FLATPACK - NO LEAD

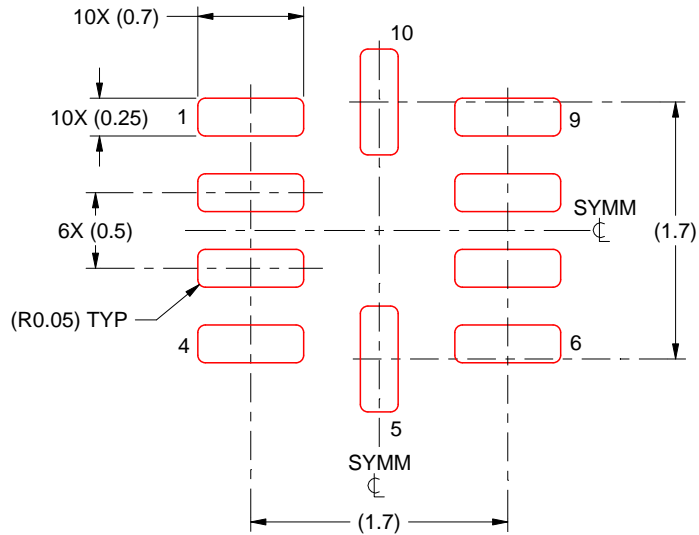

SOLDER PASTE EXAMPLE
BASED ON 0.125 MM THICK STENCIL
SCALE: 20X

4220470/A 05/2020

NOTES: (continued)

4. Laser cutting apertures with trapezoidal walls and rounded corners may offer better paste release. IPC-7525 may have alternate design recommendations.



D0008A

PACKAGE OUTLINE

SOIC - 1.75 mm max height

SMALL OUTLINE INTEGRATED CIRCUIT



4214825/C 02/2019

NOTES:

1. Linear dimensions are in inches [millimeters]. Dimensions in parenthesis are for reference only. Controlling dimensions are in inches. Dimensioning and tolerancing per ASME Y14.5M.
2. This drawing is subject to change without notice.
3. This dimension does not include mold flash, protrusions, or gate burrs. Mold flash, protrusions, or gate burrs shall not exceed $.006$ [0.15] per side.
4. This dimension does not include interlead flash.
5. Reference JEDEC registration MS-012, variation AA.

EXAMPLE BOARD LAYOUT

D0008A

SOIC - 1.75 mm max height

SMALL OUTLINE INTEGRATED CIRCUIT



LAND PATTERN EXAMPLE
 EXPOSED METAL SHOWN
 SCALE:8X



SOLDER MASK DETAILS

4214825/C 02/2019

NOTES: (continued)

- 6. Publication IPC-7351 may have alternate designs.
- 7. Solder mask tolerances between and around signal pads can vary based on board fabrication site.

EXAMPLE STENCIL DESIGN

D0008A

SOIC - 1.75 mm max height

SMALL OUTLINE INTEGRATED CIRCUIT



SOLDER PASTE EXAMPLE
BASED ON .005 INCH [0.125 MM] THICK STENCIL
SCALE:8X

4214825/C 02/2019

NOTES: (continued)

8. Laser cutting apertures with trapezoidal walls and rounded corners may offer better paste release. IPC-7525 may have alternate design recommendations.
9. Board assembly site may have different recommendations for stencil design.

IMPORTANT NOTICE AND DISCLAIMER

TI PROVIDES TECHNICAL AND RELIABILITY DATA (INCLUDING DATA SHEETS), DESIGN RESOURCES (INCLUDING REFERENCE DESIGNS), APPLICATION OR OTHER DESIGN ADVICE, WEB TOOLS, SAFETY INFORMATION, AND OTHER RESOURCES "AS IS" AND WITH ALL FAULTS, AND DISCLAIMS ALL WARRANTIES, EXPRESS AND IMPLIED, INCLUDING WITHOUT LIMITATION ANY IMPLIED WARRANTIES OF MERCHANTABILITY, FITNESS FOR A PARTICULAR PURPOSE OR NON-INFRINGEMENT OF THIRD PARTY INTELLECTUAL PROPERTY RIGHTS.

These resources are intended for skilled developers designing with TI products. You are solely responsible for (1) selecting the appropriate TI products for your application, (2) designing, validating and testing your application, and (3) ensuring your application meets applicable standards, and any other safety, security, regulatory or other requirements.

These resources are subject to change without notice. TI grants you permission to use these resources only for development of an application that uses the TI products described in the resource. Other reproduction and display of these resources is prohibited. No license is granted to any other TI intellectual property right or to any third party intellectual property right. TI disclaims responsibility for, and you will fully indemnify TI and its representatives against, any claims, damages, costs, losses, and liabilities arising out of your use of these resources.

TI's products are provided subject to [TI's Terms of Sale](#) or other applicable terms available either on ti.com or provided in conjunction with such TI products. TI's provision of these resources does not expand or otherwise alter TI's applicable warranties or warranty disclaimers for TI products.

TI objects to and rejects any additional or different terms you may have proposed.

Mailing Address: Texas Instruments, Post Office Box 655303, Dallas, Texas 75265
Copyright © 2022, Texas Instruments Incorporated