



The Future of Analog IC Technology®

# MP26057 28V, 1A Linear Li-Ion Travel Charger With Trickle Charge and Timer

## DESCRIPTION

The MP26057 is a linear, high performance single cell Li-Ion or Li-Polymer battery charger. By integrating high voltage input protection into the charger IC, the MP26057 can tolerate an input surge up to 28V.

The device features constant current (CC) and constant voltage (CV) charging modes with programmable charge currents (200mA to 1A), current blocking and trickle charge. The other features include the programmable battery full threshold, termination and auto-recharge. MP26057 provides charger status indication to drive red and green LEDs (tri-color indication).

For guaranteed safe operation, the MP26057 limits the die temperature to a preset value when the device is heated up due to limited PCB space. Other safety features are battery temperature monitoring, and programmable timer to prevent prolonged charging a dead battery.

MP26057 is available in a 10-pin 3mm x 3mm DFN package.

## FEATURES

- Complete Solution for Charging Single-Cell Lion-Ion Battery
- Input Surge Up to 28V
- Wide Input Operating Range 3.5V – 7V
- Adapter or USB Input
- Programmable Charge Current: 200mA to 1A
- Programmable Timer
- Termination and Auto-Recharge
- 0.75%  $V_{BATT}$  Accuracy over Temperature
- $<1\mu A$  Battery Reverse Current
- 125 $\mu A$  Standby Current from  $V_{IN}$
- Battery Temperature Monitoring
- Automatic Die Temperature Limiting
- Fault and Charge Status Indicators
- Soft-Start to Limit Inrush Current
- Tiny 3mm x 3mm QFN Package

## APPLICATIONS

- Cell Phones
- Digital Cameras
- Smart Phones
- PDAs
- MP3 Players

All MPS parts are lead-free, halogen free, and adhere to the RoHS directive. For MPS green status, please visit MPS website under Quality Assurance. "MPS" and "The Future of Analog IC Technology" are Registered Trademarks of Monolithic Power Systems, Inc.

## TYPICAL APPLICATION

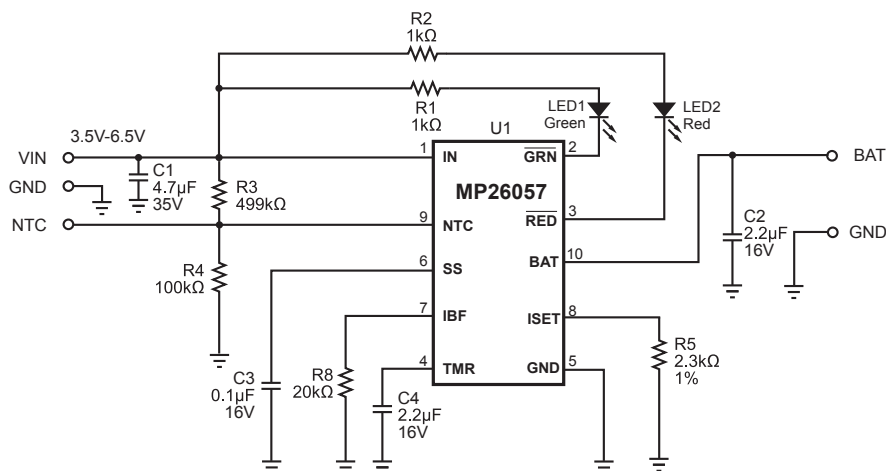

## PACKAGE REFERENCE

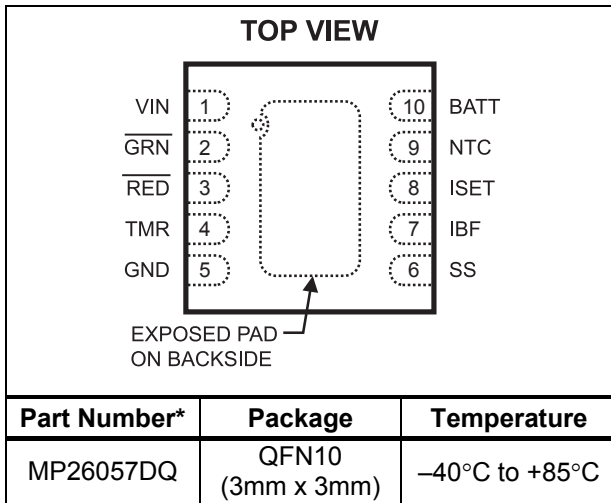

\* For Tape & Reel, add suffix -Z (eg. MP26057DQ-Z)  
 For RoHS compliant packaging, add suffix -LF  
 (eg. MP26057DQ-LF-Z)

## ABSOLUTE MAXIMUM RATINGS <sup>(1)</sup>

IN to GND..... -0.3V to +28V  
 $\overline{\text{GRN}}$  &  $\overline{\text{RED}}$  Maximum Sink Current ..... 20mA  
 All Other Pins to GND ..... -0.3V to +6.5V  
 Junction Temperature ..... 140°C  
 Lead Temperature ..... 260°C  
 Storage Temperature..... -65°C to +150°C

## Recommended Operating Conditions <sup>(2)</sup>

Nominal Supply Voltage  $V_{\text{IN}}$ ..... 3.5V to 5.5V  
 Operating Temperature ..... -40°C to +85°C

## Thermal Resistance <sup>(3)</sup> $\theta_{\text{JA}}$ $\theta_{\text{JC}}$

3x3 QFN10 ..... 50 ..... 12 ... °C/W

### Notes:

- 1) Exceeding these ratings may damage the device.
- 2) The device is not guaranteed to function outside of its operating conditions.
- 3) Measured on JEDEC51-7 4 layer board..

## ELECTRICAL CHARACTERISTICS

$V_{\text{IN}} = 5\text{V}$ ,  $T_{\text{A}} = +25^\circ\text{C}$ , unless otherwise noted.

| Parameter  | Symbol              | Condition  | Min  | Typ  | Max  | Units                             |
|--|---------------------|--|------|------|------|-----------------------------------|
| Supply Current   | $I_{\text{SUPPLY}}$ | $I_{\text{CHG}} = 0\text{A}$ , $V_{\text{BATT}} = 4.2\text{V}$   |      | 140  |      | $\mu\text{A}$                     |
| Battery Voltage Regulation   | $V_{\text{BATT}}$   | $T = -5^\circ\text{C}$ to $+75^\circ\text{C}$ , $I_{\text{BATT}} = 0$  | 4.16 | 4.20 | 4.24 | V                                 |
| Constant Current Regulation  | $I_{\text{CHG}}$    | $V_{\text{IN}} = 5\text{V}$ , $V_{\text{BATT}} = 3.8\text{V}$<br>$R_{\text{CHG}} = 3.3\text{k}\Omega$  | 452  | 515  | 582  | mA                                |
| Constant Current Variation   |                     | $V_{\text{IN}} = 5\text{V}$ , $V_{\text{BATT}} = 3.8\text{V}$ ,<br>$T_{\text{J}} = 0^\circ\text{C}$ to $+120^\circ\text{C}$ ,<br>$R_{\text{CHG}} = 1.6\text{k}\Omega$ to $8.0\text{k}\Omega$ | 87   | 100  | 113  | % $I_{\text{CHG}}$ <sup>(4)</sup> |
| Trickle Current  |                     | $V_{\text{IN}} = 5\text{V}$ , $V_{\text{BATT}} = 2.3\text{V}$  | 5    | 10   | 15   | % $I_{\text{CHG}}$ <sup>(4)</sup> |
| Trickle Threshold Voltage  |                     | $V_{\text{BAT}}$ Rising  | 2.45 | 2.6  | 2.75 | V                                 |
| Trickle Voltage Hysteresis   |                     |  |      | 100  |      | mV                                |
| IBF Accuracy   |                     |  | 75   |      | 125  | % $I_{\text{BF}}$ <sup>(5)</sup>  |
| Input OVP  |                     | $V_{\text{IN}}$ rising   | 6.8  | 7    | 7.2  | V                                 |
| OVP Hysteresis   |                     |  |      | 400  |      | mV                                |
| Input UVLO   |                     | $V_{\text{IN}}$ rising   | 2.5  | 3    | 3.5  | V                                 |
| UVLO Hysteresis  |                     |  |      | 100  |      | mV                                |
| $\overline{\text{GRN}}$ and $\overline{\text{RED}}$ Over Voltage Clamp | $V_{\text{Z}}$      |  |      | 7.6  |      | V                                 |

**ELECTRICAL CHARACTERISTICS** *(continued)*
**V<sub>IN</sub> = 5V, T<sub>A</sub> = +25°C, unless otherwise noted.**

| Parameter                           | Symbol                                 | Condition  | Min  | Typ   | Max  | Units |
|-------------------------------------|--|--|------|-------|------|-------|
| RED/GRN Sink Current                |  | Pin Voltage = 0.3V   | 5    |       |      | mA    |
| Battery Reverse Current to BATT Pin |  | V <sub>IN</sub> is Floating or 0V, V <sub>BAT</sub> =4.2V          |      |       | 1    | μA    |
| Dropout Voltage                     | V <sub>IN</sub> -<br>V <sub>BATT</sub> | V <sub>BATT</sub> = 3.8V, R <sub>CHG</sub> = 6kΩ. Current drop 10% |      | 0.25  |      | V     |
| Soft Thermal Shutdown Threshold     |  |  | 105  | 120   | 135  | °C    |
| Soft Thermal Shutdown Hysteresis    |  |  |      | 10    |      | °C    |
| Soft-Start Time                     |  | C <sub>SS</sub> =0.1μF, V <sub>SS</sub> >1.1V                      |      | 100   |      | ms    |
| Recharge Voltage Threshold          | V <sub>RECHARGE</sub>                  |  | 3.9  | 4.0   | 4.1  | V     |
| Recharge Voltage Hysteresis         |  |  |      | 100   |      | mV    |
| R_NTC at 0°C                        | TH11-<br>4H104F                        | Note: R_NTC is 100k at 25°C  |      | 376.6 |      | kΩ    |
| R_NTC at 50°C                       | TH11-<br>4H104F                        | Note: R_NTC is 100k at 25°C  |      | 32.3  |      | kΩ    |
| Oscillation Freq                    |  | C <sub>TMR</sub> = 2.2μF   |      | 5     |      | Hz    |
| TMR Pin Source Current              | Itmr1                                  | V <sub>TMR</sub> =0.1V   | 18   | 20    | 22   | μA    |
| TMR Pin Sink Current                | Itmr2                                  | V <sub>TMR</sub> =1.5V   | 18   | 20    | 22   | μA    |
| NTC Up Range                        |  | V <sub>NTC</sub> Rising  | 2.05 | 2.15  | 2.25 | V     |
| Hysteresis                          |  |  |      | 150   |      | mV    |
| NTC Low Range                       |  | V <sub>NTC</sub> Falling   | 0.27 | 0.3   | 0.33 | V     |
| Hysteresis                          |  |  |      | 30    |      | mV    |

**Notes:**

- 4) I<sub>CHG</sub> is the target preprogrammed charge current (Die temperature below 110°C).  
 5) I<sub>BF</sub> is the target preprogrammed battery full current threshold

## PIN FUNCTIONS

| Pin # | Name                   | Description   |
|-------|------------------------|---|
| 1     | IN                     | Input Supply Pin. IN receives the AC adapter.   |
| 2     | GRN                    | Open-Drain Charger Status Indicator.  |
| 3     | RED                    | Open-Drain Charger Status Indicator.  |
| 4     | TMR                    | Oscillator Period Timer. Connect a timing capacitor between this pin and GND to set the oscillator period. Short this pin to ground to disable timer.   |
| 5     | GND,<br>Exposed<br>Pad | Ground. The exposed pad and GND pin must be connected to the same ground plane.   |
| 6     | SS                     | Soft Start Pin. Connect to a 0.1 $\mu$ F or higher capacitor to program the soft start time   |
| 7     | ISET                   | Constant Charge Current Program Pin. Connect this pin to an external resistor to program the charging current in CC Mode.   |
| 8     | IBF                    | Charge Status Threshold Program. Connect this pin to an external resistor to program the charge termination current or battery full indication threshold.   |
| 9     | NTC                    | Negative Temperature Coefficient (NTC) Thermistor Pin. Connect a 500k $\Omega$ resistor from this pin to the IN pin and a 100k $\Omega$ NTC resistor (within the battery pack) from this pin to ground. If NTC function is not used, replace NTC resistor with a regular 100k $\Omega$ resistor from this pin to ground. <b>Do not leave this pin floating.</b> |
| 10    | BATT                   | Charger Output.   |

## TYPICAL PERFORMANCE CHARACTERISTICS

$V_{IN} = 5V$ ,  $C_{IN} = 4.7\mu F$ ,  $C_{OUT} = 2.2\mu F$ ,  $I_{BF} = 20k\Omega$ ,  $T_A = +25^\circ C$ , unless otherwise noted.

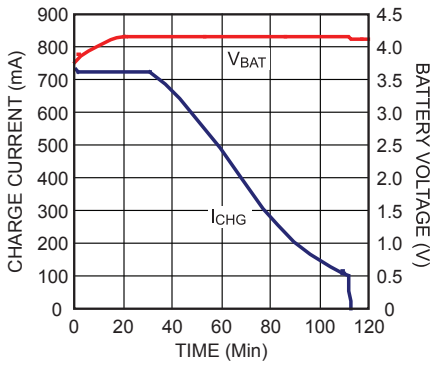
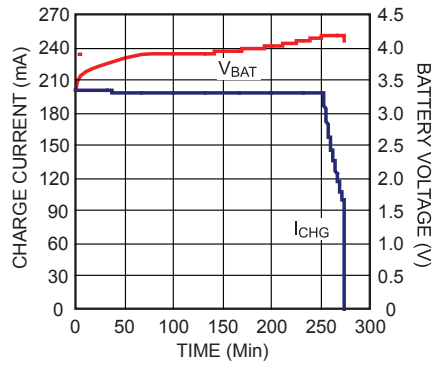
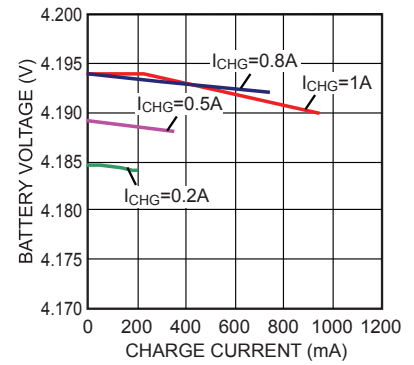
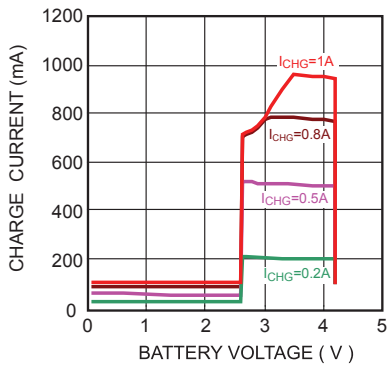
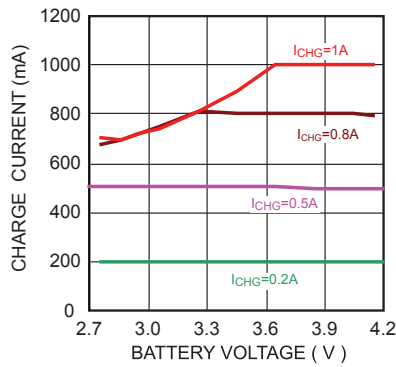
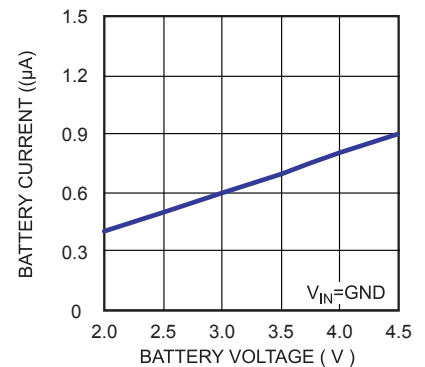
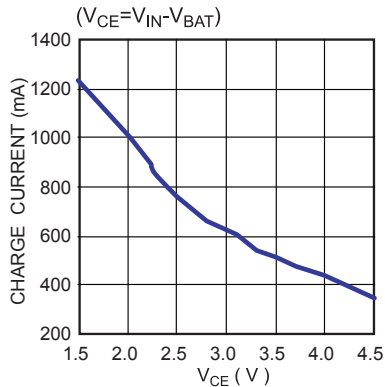
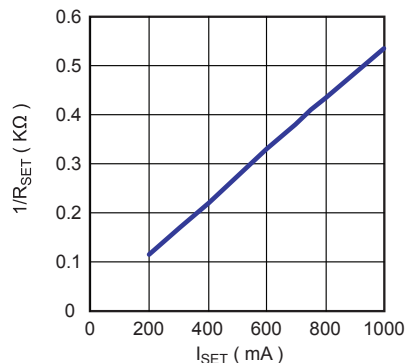
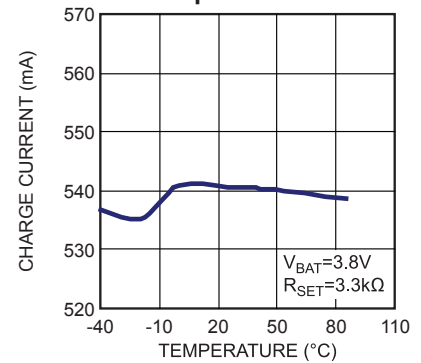
**800mA Charge Curve**

**200mA Charge Curve**

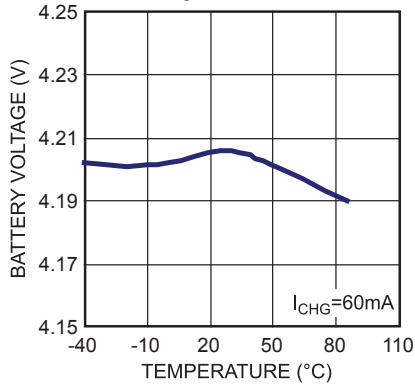
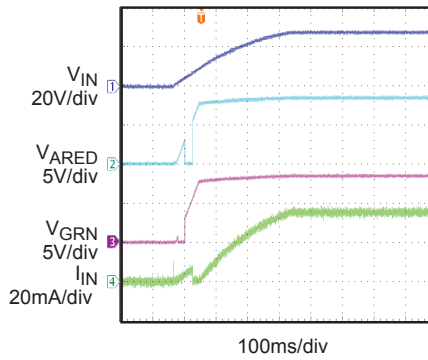
**Constant Voltage Charge**

**I – V Charge Curve**

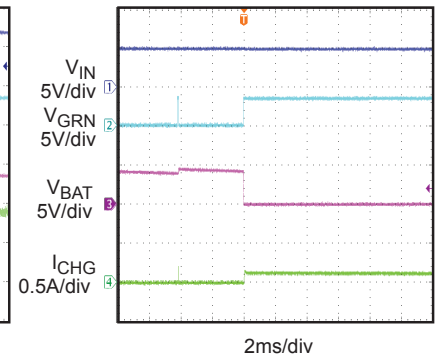
**Constant Current Charge**

**Battery Sink Current**

**Thermal Protection**

**R<sub>SET</sub> Resistance vs. I<sub>SET</sub>**

**Constant Current Charge vs. Temperature**

**TYPICAL PERFORMANCE CHARACTERISTICS (continued)**
 $V_{IN} = 5V$ ,  $C_{IN} = 4.7\mu F$ ,  $C_{OUT} = 2.2\mu F$ ,  $I_{BF} = 20k\Omega$ ,  $T_A = +25^\circ C$ , unless otherwise noted.

**Constant Voltage Charge vs. Temperature**

**Maximum Input Voltage**
 $V_{IN} = 28V$ , No Battery

**Short Circuit**

No Battery

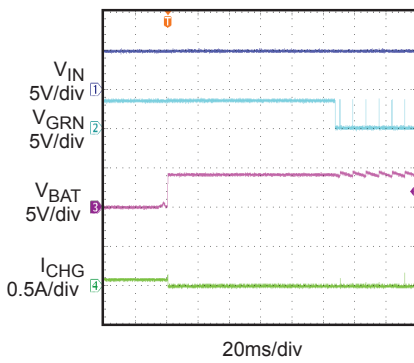
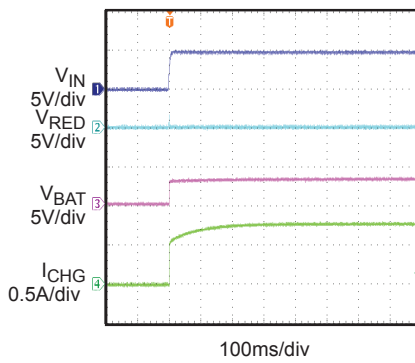
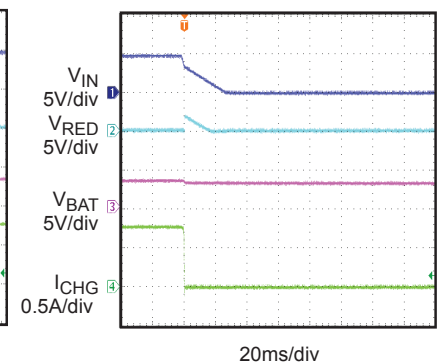
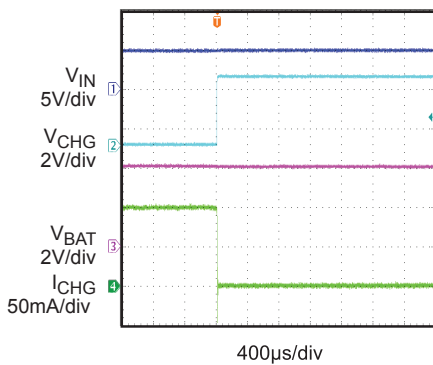
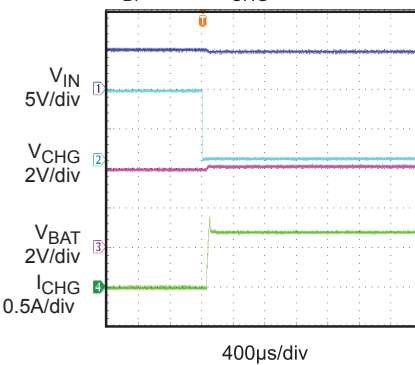
**Short Circuit Recovery**

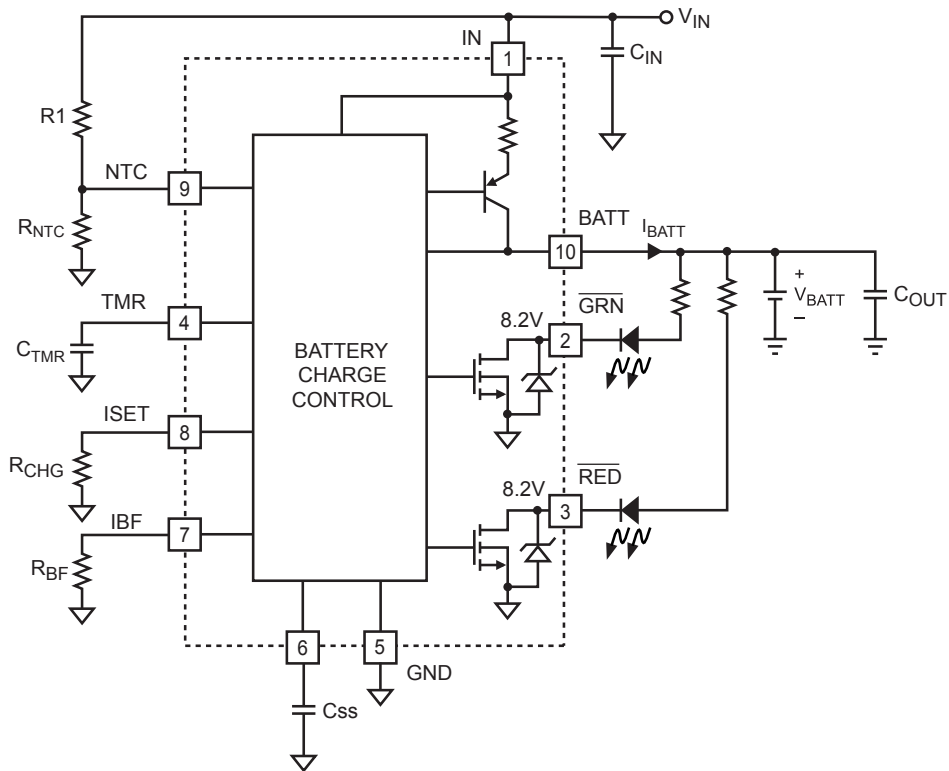
No Battery

**Power Rump Up**
 $R_{SET} = 2.26k\Omega$ ,  $C_{SS} = 0.1\mu F$ 

**Power Rump Down**
 $R_{SET} = 2.26k\Omega$ ,  $C_{SS} = 0.1\mu F$ 

**Charge Full Terminated**
 $R_{BF} = 20k\Omega$ ,  $I_{CHG} = 0.8A$ 

**Charge Terminated to Re-Charge**
 $R_{BF} = 20k\Omega$ ,  $I_{CHG} = 0.8A$ 

**BLOCK DIAGRAM**

**Figure 1: Functional Block Diagram**

## OPERATION

### Input Voltage Range

The MP26057 has built-in input voltage surge protection as high as +28V. The charger IC will be automatically enabled when the input voltage is higher than 3.0 and lower than 7.0V. If the input voltage is lower than the battery voltage, the IC is also disabled to prevent the battery from draining.

### Charge Cycle (Mode Change: Trickle -> CC-> CV)

Figure 2 below shows the typical charging profile for the MP26057. For a fully depleted battery with a terminal voltage lower than 2.6V, the MP26057 will start with the trickle charge (preconditioning) at 10% of the full charge current based on the value of  $R_{PGM}$ . If the charger stays in the trickle mode longer than 32768 cycles, RED/GRN pins become flashing indicating battery fault. After the battery voltage reaches 2.6V, the charger begins charging at the constant current of the programmed value ( $I_{CHG}$ ). This is referred to as Constant Current (CC) mode. Once the battery voltage reaches 4.2V, the charger will operate in the constant voltage (CV) mode until the battery is fully charged. The charge current drops during CV mode, and the battery full indication is set when the charge current reduced to the preset value based on  $R_{IBF}$ , and the charge process terminated. Recharge will start after the battery voltage is for some reason reduced to 4.0V. After 262144 cycles of continuous charging, if the battery is still not reaching IBF condition, the on-chip timer will terminate the charger to prevent charging the dead battery for excessive long time and the fault condition will be flagged by flashing the RED/GRN LEDs.

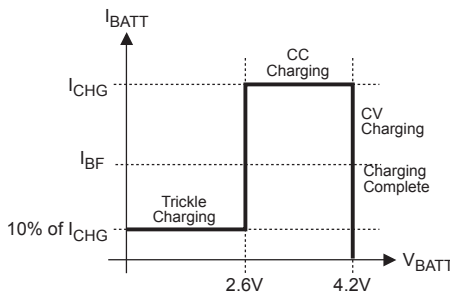

**Figure 2: MP26057 Typical Charging Profile**

### Charge termination

The charge current will gradually decrease in CV mode as the battery approaches full. The battery full threshold can be programmed by connecting a resistor from IBF pin to ground. When the charge current reaches this threshold, the charger IC will be automatically turned off. The battery voltage may decay after termination due to self discharge or system draw current from the battery.

### Automatic Recharge

Upon  $V_{BATT}$  drops to 4.0V, the charger will automatically restart the charge cycle until the IBF condition is met again. When the input adapter is unplugged or the charger is disabled and/or terminated, the leakage current from the battery to MP26057 is less than 1 $\mu$ A.

### Programming of Charge Current and Battery Full Current

**Table 1:  $R_{PGM}$  and  $I_{CHG}$  Relationship**

| $R_{PGM}$ (k $\Omega$ ) | $I_{CHG}$ (mA) |
|-------------------------|----------------|
| 1.65                    | 1000           |
| 1.82                    | 900            |
| 2.05                    | 800            |
| 2.32                    | 700            |
| 2.74                    | 600            |
| 3.3                     | 500            |
| 4.12                    | 400            |
| 5.6                     | 300            |
| 8.45                    | 200            |
| 15                      | 100            |

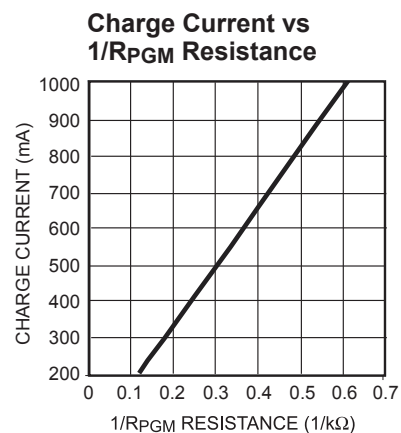

**Figure 3: Charge Current vs. 1/ $R_{PGM}$  Resistance**



The charge current ( $I_{CHG}$ ) is set by a resistor ( $R_{PGM}$ ) connecting from the ISET pin to GND. The relationship of the charge current and the programming resistance is established by the following table and graph.

The recommended resistance for programming the charge current is  $2.3k\Omega < R_{CHG} < 11k\Omega$ . The battery full charge current threshold ( $I_{BF}$ ) is programmed by connecting a resistor  $R_{BF}$  from the IBF pin to GND:

$$I_{BF} = \frac{1A \times 1.7k\Omega}{R_{BF}}$$

Where  $2R_{PGM} < R_{BF} < 10R_{PGM}$ . The open-drain pin  $\overline{CHG}$  is used to indicate charging status. When the battery full condition is reached or any other condition prevents the charger from charging,  $\overline{CHG}$  will become a floating.

#### Timer Operation

The TMR pin is used to set the internal oscillator frequency:  $F_{OSC} = 11Hz \times \frac{\mu F}{C_{TMR}}$ . The on-chip timer

will start count down after initial power-up or every time being enabled. This timer will limit the max trickle-charge time to 32768 internal oscillating cycles. If the charger stays in trickle mode for longer than 32768 cycles, it will be terminated and a fault will be set by flashing both status LEDs. After fault reporting, the charger can be re-initiated only by recycling the power supply. If the charger successfully went through trickle charge within the allowed time limit, it will start CC charge and then CV charge. If the total charge time exceeds 262144 cycles and the battery full has not been qualified, the charger

will be terminated and a fault will also be set by flashing both status LEDs at the rate of half the internal oscillation frequency. This function prevents charging a dead battery for prolonged duration. The timer function can be disabled by shorting TMR pin to ground.

#### Negative Thermal Coefficient (NTC) Thermistor

The MP26057 has a built-in NTC resistance window comparator. If configured as the typical application circuit as indicated in Figure 1, the MP26057 will cease charging if  $R_{NTC} < 32.3k\Omega$  or  $R_{NTC} > 376.6k\Omega$ . This represents a valid charging temperature range of  $0^{\circ}C$  to  $50^{\circ}C$  for the TH11-4H104F NTC resistor.

#### Thermal Protection

The MP26057 has proprietary thermal protection to prevent the IC from overheating. When in thermal protection mode, the charge current becomes a saw-tooth waveform instead of a DC current. The average current of the saw-tooth waveform will be lower than the programmed DC charge current to prevent the IC from overheating. Operating in thermal protection mode will slow down the charging process. Lowering the input voltage and enhancing thermal dissipation to the environment can effectively prevent the IC from going into thermal protection mode.

#### Charger Status Indication (RED & GREEN)

MP26057 has two charge status pins RED and GREEN, which can indicate and tell the charging status by changing their states (ON/OFF/Flashing) as Table 2 shows.

**Table 2: Charger Status Indication**

|       | Charging | Battery Full & No Batt | Timeout Fault | Vin>7V | Batt Cold | Batt Hot  |
|-------|----------|------------------------|---------------|--------|-----------|-----------|
| RED   | ON       | OFF                    | Flashing      | OFF    | OFF       | <b>ON</b> |
| GREEN | OFF      | ON                     | Flashing      | OFF    | OFF       | <b>ON</b> |

## APPLICATION

### Flow Chart of Operation

Power-On Reset (POR) feature can be applied To the MP26057 to ensure that the device starts Operating in a known state. The flow chart in

Figure 4 describes the conditions and operation Modes of the MP26057. CVC and CCC stand for “constant voltage charge” and “constant current charge”, respectively.

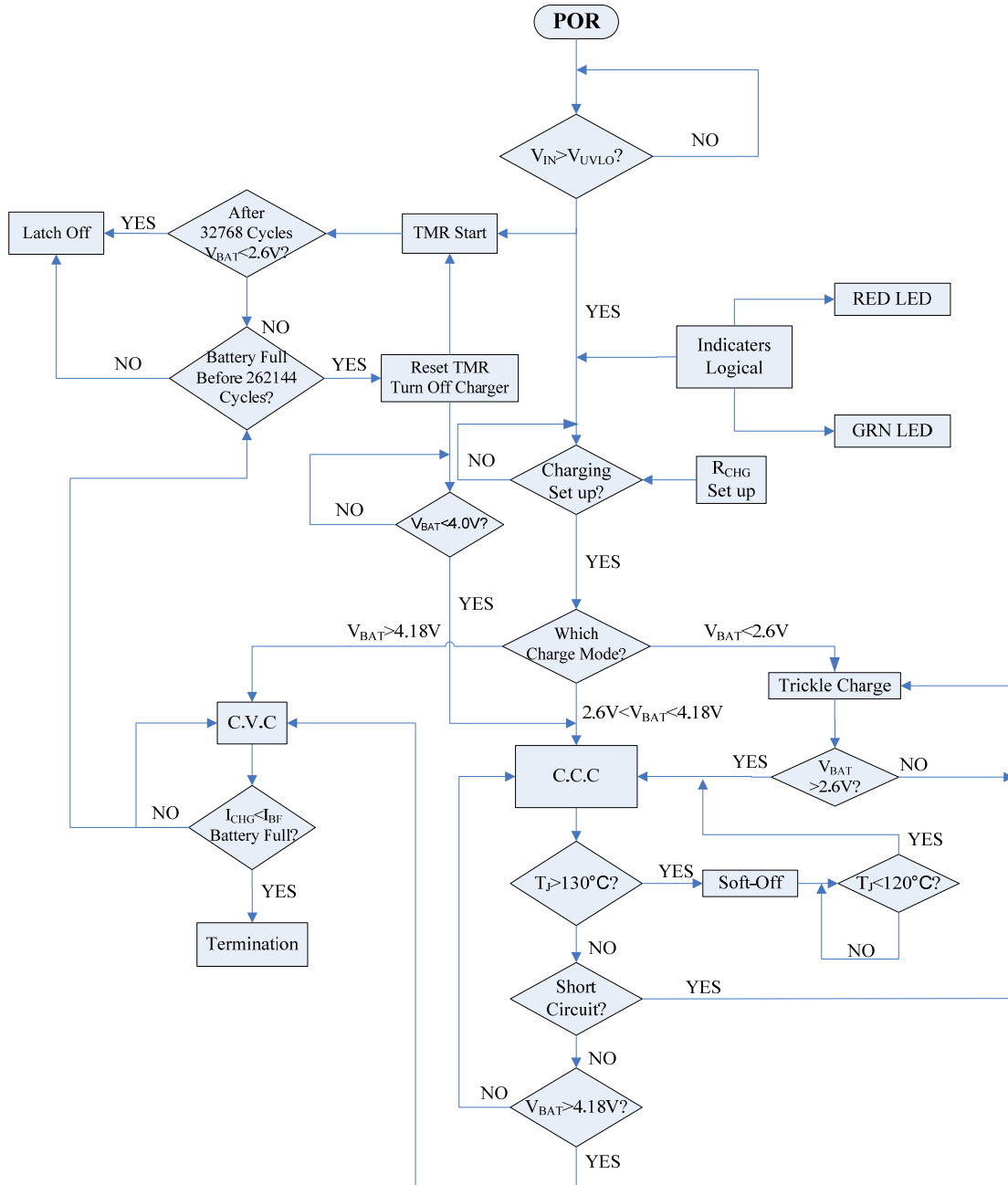

**Figure 4: Flow Chart Operation**

**PACKAGE INFORMATION**

**QFN10 (3mm x 3mm)**

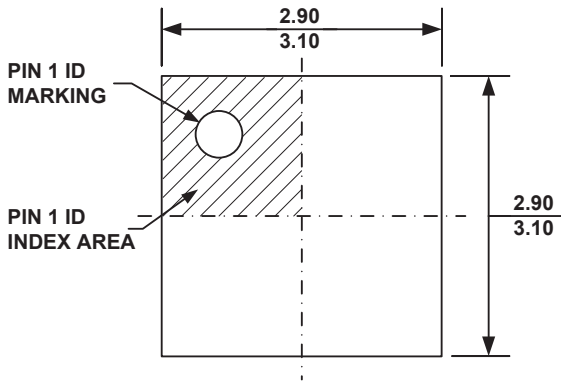

**TOP VIEW**

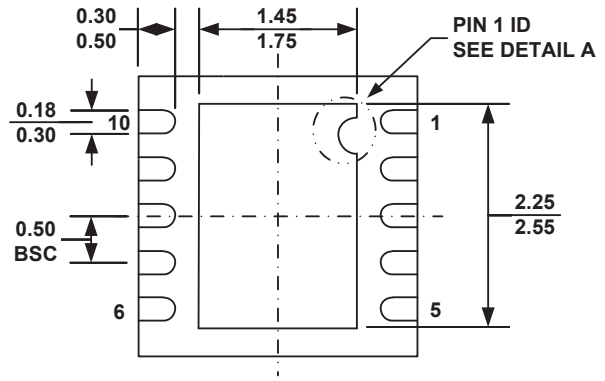

**BOTTOM VIEW**

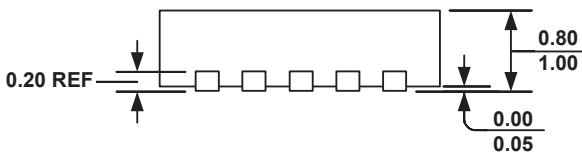

**SIDE VIEW**

**PIN 1 ID OPTION A  
R0.20 TYP.**

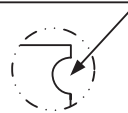

**PIN 1 ID OPTION B  
R0.20 TYP.**

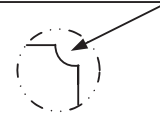

**DETAIL A**

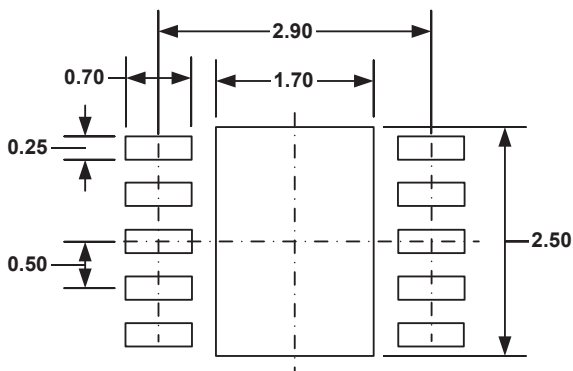

**RECOMMENDED LAND PATTERN**

**NOTE:**

- 1) ALL DIMENSIONS ARE IN MILLIMETERS.
- 2) EXPOSED PADDLE SIZE DOES NOT INCLUDE MOLD FLASH.
- 3) LEAD COPLANARITY SHALL BE 0.10 MILLIMETER MAX.
- 4) DRAWING CONFORMS TO JEDEC MO-229, VARIATION VEED-5.
- 5) DRAWING IS NOT TO SCALE.

**NOTICE:** The information in this document is subject to change without notice. Users should warrant and guarantee that third party Intellectual Property rights are not infringed upon when integrating MPS products into any application. MPS will not assume any legal responsibility for any said applications.