

HA-5033

250MHz Video Buffer

FN2924  
Rev 8.00  
February 6, 2006

The HA-5033 is a unity gain monolithic IC designed for any application requiring a fast, wideband buffer. Featuring a bandwidth of 250MHz and outstanding differential phase/gain characteristics, this high performance voltage follower is an excellent choice for video circuit design. Other features, which include a minimum slew rate of 1000V/μs and high output drive capability, make the HA-5033 applicable for line driver and high speed data conversion circuits.

The high performance of this product is a result of the Intersil Dielectric Isolation process. A major feature of this process is that it produces both PNP and NPN high frequency transistors which makes wide bandwidth designs, such as the HA-5033, practical. Alternative process methods typically produce a lower AC performance.

**Ordering Information**

PART NUMBER	PART MARKING	TEMP. RANGE (°C)	PACKAGE	PKG. DWG. #
HA2-5033-2	HA2-5033-2	-55 to 125	12 Pin Metal Can	T12.C
HA3-5033-5	HA3-5033-5	0 to 75	8 Ld PDIP	E8.3

**Pinouts**

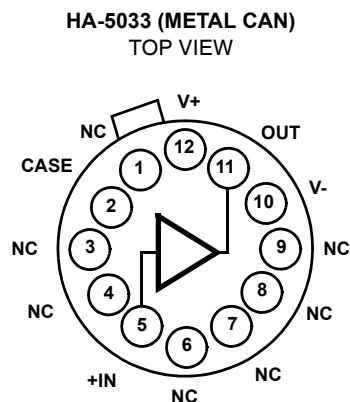
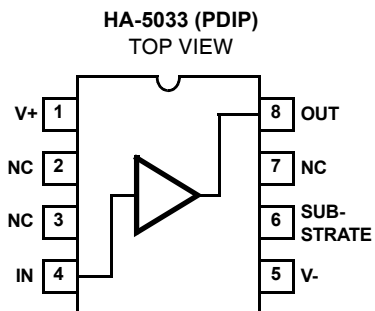

**Features**

- Differential Phase Error . . . . . 0.02 Degrees
- Differential Gain Error . . . . . 0.03%
- High Slew Rate . . . . . 1100V/μs
- Wide Bandwidth (Small Signal) . . . . . 250MHz
- Wide Power Bandwidth . . . . . DC to 17.5MHz
- Fast Rise Time . . . . . 3ns
- High Output Drive. . . . . ±10V With 100Ω Load
- Wide Power Supply Range . . . . . ±5V to ±16V
- Replace Costly Hybrids

**Applications**

- Video Buffer
- High Frequency Buffer
- Isolation Buffer
- High Speed Line Driver
- Impedance Matching
- Current Boosters
- High Speed A/D Input Buffers
- Related Literature
  - AN548, Designer's Guide for HA-5033

**Absolute Maximum Ratings**

Voltage Between V+ and V- Pins. . . . . 40V  
 DC Input Voltage . . . . . V+ to V-  
 Output Current (Peak) (50ms On/1 Second Off) . . . . . ±200mA  
 ESD Rating  
 Human Body Model (Per MIL-STD-883 Method 3015.7) . . . . . 2000V

**Thermal Information**

Thermal Resistance (Typical, Note 2)  $\theta_{JA}$  (°C/W)  $\theta_{JC}$  (°C/W)  
 Metal Can Package . . . . . 65 34  
 PDIP Package . . . . . 120 N/A  
 Maximum Junction Temperature (Note 1) . . . . . 175°C  
 Maximum Junction Temperature (Plastic Packages) . . . . . 150°C  
 Maximum Storage Temperature Range . . . . . -65°C to 150°C  
 Maximum Lead Temperature (Soldering 10s) . . . . . 300°C

**Operating Conditions**

Temperature Ranges (Note 3)  
 HA-5033-2 . . . . . -55°C to 125°C  
 HA-5033-5 . . . . . 0°C to 75°C

*CAUTION: Stresses above those listed in "Absolute Maximum Ratings" may cause permanent damage to the device. This is a stress only rating and operation of the device at these or any other conditions above those indicated in the operational sections of this specification is not implied.*

**NOTES:**

1. Maximum power dissipation, including load conditions, must be designed to maintain the maximum junction temperature below 175°C for the metal can package, and below 150°C for the plastic packages (See Figure 5.).
2.  $\theta_{JA}$  is measured with the component mounted on an evaluation PC board in free air.
3. The maximum operating temperature may have to be derated depending on the output load condition. See Figure 5 for more information.

**Electrical Specifications**  $V_{SUPPLY} = \pm 12V$ ,  $R_S = 50\Omega$ ,  $R_L = 100\Omega$ ,  $C_L = 10pF$ , Unless Otherwise Specified

PARAMETER	TEST CONDITIONS	TEMP. (°C)	HA-5033-2			HA-5033-5			UNITS
			MIN	TYP	MAX	MIN	TYP	MAX	
<b>INPUT CHARACTERISTICS</b>									
Offset Voltage		25	-	5	15	-	5	15	mV
		Full	-	6	25	-	6	25	mV
Average Offset Voltage Drift		Full	-	33	-	-	33	-	$\mu V/^\circ C$
Bias Current		25	-	20	35	-	20	35	$\mu A$
		Full	-	30	50	-	30	50	$\mu A$
Input Resistance		25	-	3	-	-	3	-	M $\Omega$
Input Capacitance		25	-	1.6	-	-	1.6	-	pF
Input Noise Voltage	10Hz to 100MHz	25	-	20	-	-	20	-	$\mu V_{P-P}$
<b>TRANSFER CHARACTERISTICS</b>									
Voltage Gain	$R_L = 100\Omega$	25	0.93	-	-	0.93	-	-	V/V
	$R_L = 1k\Omega$	25	0.93	0.99	-	0.93	0.99	-	V/V
	$R_L = 100\Omega$	Full	0.92	-	-	0.92	-	-	V/V
-3dB Bandwidth		25	-	250	-	-	250	-	MHz
<b>OUTPUT CHARACTERISTICS</b>									
Output Voltage Swing	$R_L = 100\Omega$	Full	±8	±10	-	±8	±10	-	V
	$R_L = 1k\Omega, V_S = \pm 15V$	Full	±11	±12	-	±11	±12	-	V
Output Current		25	±80	±100	-	±80	±100	-	mA
Output Resistance		25	-	8	-	-	8	-	$\Omega$
Full Power Bandwidth	$V_{OUT} = 1V_{RMS}, R_L = 1k\Omega$	25	-	146	-	-	146	-	MHz
Full Power Bandwidth (Note 4)		25	15.9	17.5	-	15.9	17.5	-	MHz
<b>TRANSIENT RESPONSE</b>									
Rise Time	$V_{OUT} = 500mV$	25	-	4.6	-	-	4.6	-	ns
Propagation Delay		25	-	1	-	-	1	-	ns

**Electrical Specifications**  $V_{SUPPLY} = \pm 12V$ ,  $R_S = 50\Omega$ ,  $R_L = 100\Omega$ ,  $C_L = 10pF$ , Unless Otherwise Specified (Continued)

PARAMETER	TEST CONDITIONS	TEMP. (°C)	HA-5033-2			HA-5033-5			UNITS
			MIN	TYP	MAX	MIN	TYP	MAX	
Overshoot		25	-	3	-	-	3	-	%
Slew Rate (Note 4)		25	1	1.1	-	1	1.1	-	V/ns
Settling Time to 0.1%		25	-	50	-	-	50	-	ns
Differential Phase Error (Note 5)		25	-	0.02	-	-	0.02	-	Degree
Differential Gain Error (Note 5)		25	-	0.03	-	-	0.03	-	%
<b>POWER SUPPLY CHARACTERISTICS</b>									
Supply Current		25	-	21	25	-	21	25	mA
		Full	-	21	30	-	21	30	mA
Power Supply Rejection Ratio		Full	54	-	-	54	-	-	dB
Harmonic Distortion	$V_{IN} = 1V_{RMS}$ at 100kHz	25	-	<0.1	-	-	<0.1	-	%

NOTES:

- $V_{SUPPLY} = \pm 15V$ ,  $V_{OUT} = \pm 10V$ ,  $R_L = 1k\Omega$ .
- Differential gain and phase error are nonlinear signal distortions found in video systems and are defined as follows: Differential gain error is defined as the change in amplitude at the color subcarrier frequency as the picture signal is varied from blanking to white level. Differential phase error is defined as the change in the phase of the color subcarrier as the picture signal is varied from blanking to white level.  $R_L = 300\Omega$ .

**Test Circuits and Waveforms**

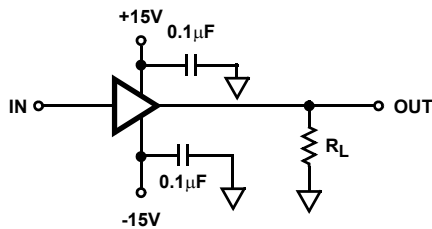

FIGURE 1. SLEW RATE AND SETTLING TIME

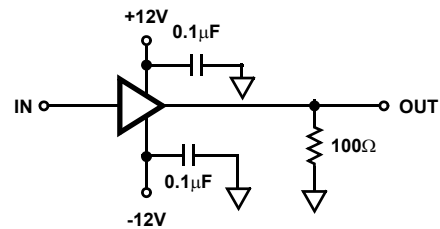

FIGURE 2. TRANSIENT RESPONSE

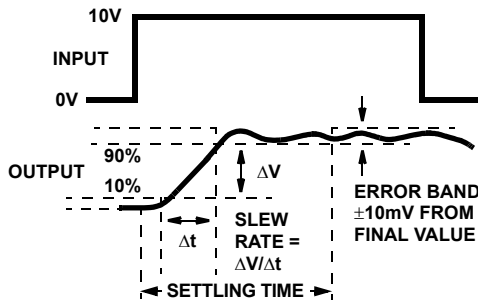

FIGURE 3. SETTLING TIME AND SLEW RATE

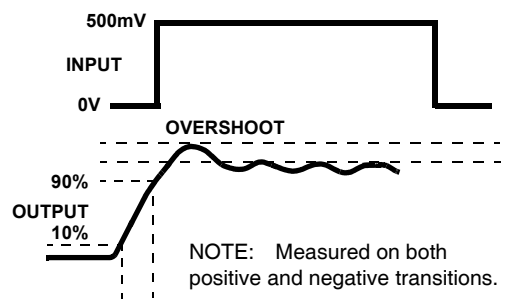
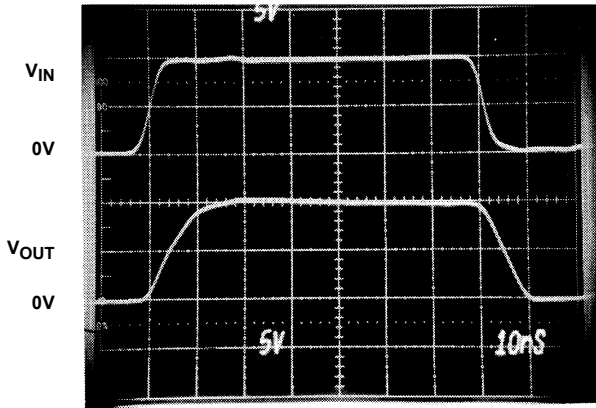

FIGURE 4. RISE TIME AND OVERSHOOT

**Test Circuits and Waveforms** (Continued)



$T_A = 25^\circ\text{C}, R_S = 50\Omega, R_L = 100\Omega$

**+10V RESPONSE**

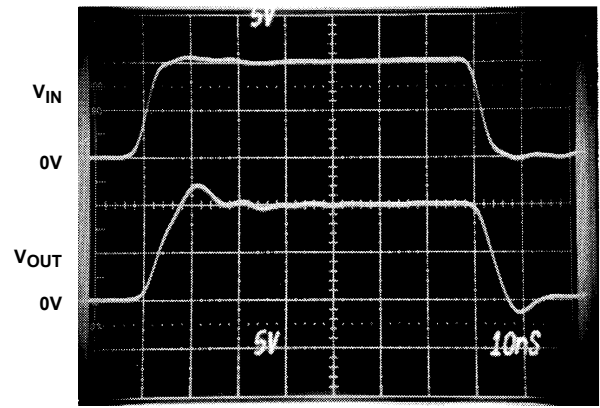

$T_A = 25^\circ\text{C}, R_S = 50\Omega, R_L = 1\text{k}\Omega$

**+10V RESPONSE**

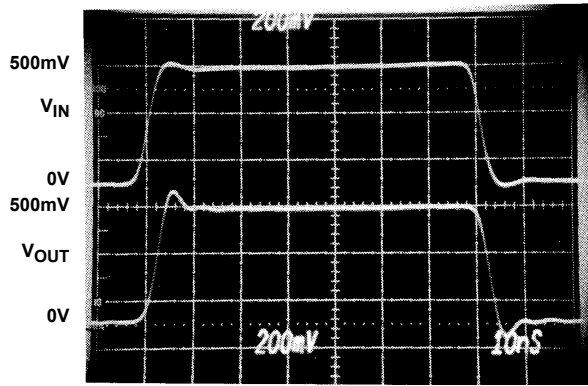

$T_A = 25^\circ\text{C}, R_S = 50\Omega, R_L = 100\Omega$

**PULSE RESPONSE**

**Schematic Diagram**

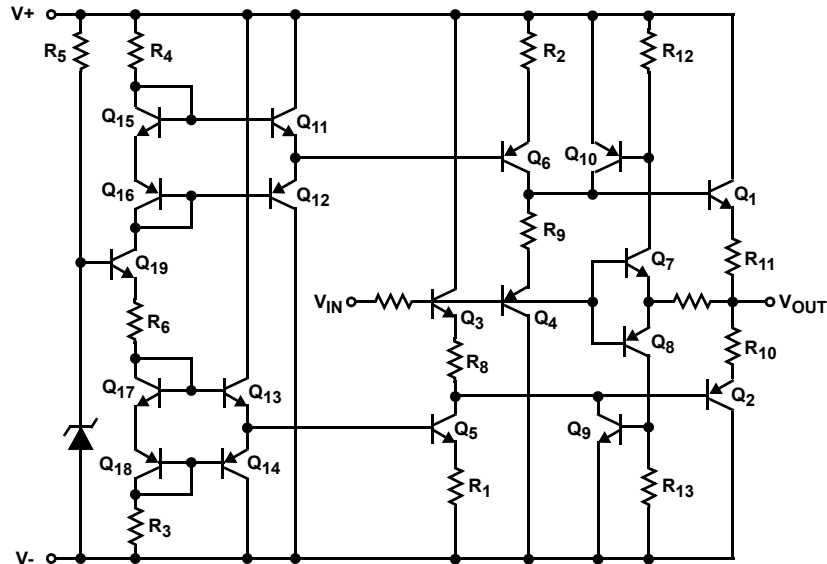

## Application Information

### Layout Considerations

The wide bandwidth of the HA-5033 necessitates that high frequency circuit layout procedures be followed. Failure to follow these guidelines can result in marginal performance.

Probably the most crucial of the RF/video layout rules is the use of a ground plane. A ground plane provides isolation and minimizes distributed circuit capacitance and inductance which will degrade high frequency performance. IC sockets contribute inter-lead capacitance which limits device bandwidth and should be avoided.

Pin 6 can be tied to either supply, grounded, or simply not used. But to optimize device performance and improve isolation, it is recommended that this pin be grounded.

Other considerations are proper power supply bypassing and keeping the input and output connections as short as possible which minimizes distributed capacitance and reduces board space.

### Power Supply Decoupling

For optimum device performance, it is recommended that the positive and negative power supplies be bypassed with capacitors to ground. Ceramic capacitors ranging in value from 0.01µF to 0.1µF will minimize high frequency variations in supply voltage. Solid tantalum capacitors 1µF or larger will optimize low frequency performance.

### Typical Applications (Also see Application Note AN548)

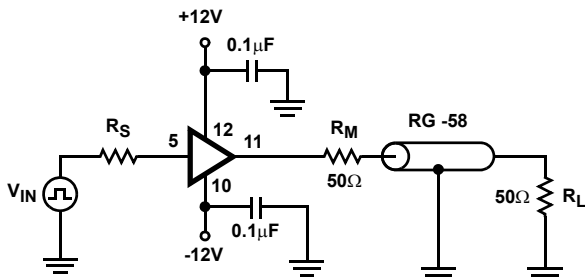

FIGURE 6. VIDEO COAXIAL LINE DRIVER 50Ω SYSTEM

It is also recommended that the bypass capacitors be connected close to the HA-5033 (preferably directly to the supply pins).

Figure 5 is based on:

$$P_{D\text{MAX}} = \frac{T_{J\text{MAX}} - T_A}{\theta_{JA}}$$

Where:  $T_{J\text{MAX}}$  = Maximum Junction Temperature of the Device  
 $T_A$  = Ambient Temperature

$\theta_{JA}$  = Junction to Ambient Thermal Resistance

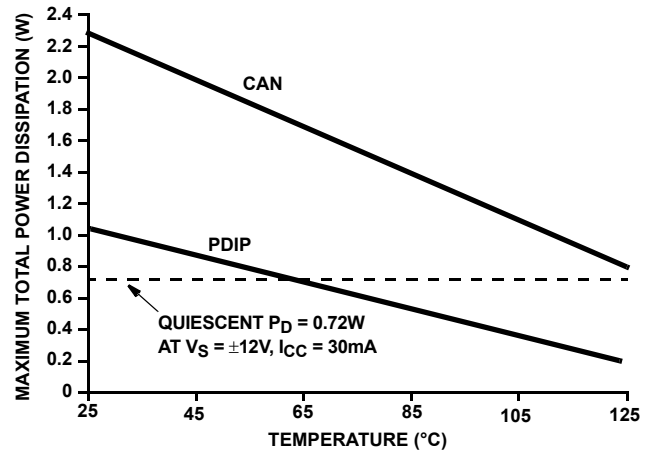

FIGURE 5. MAXIMUM POWER DISSIPATION vs TEMPERATURE

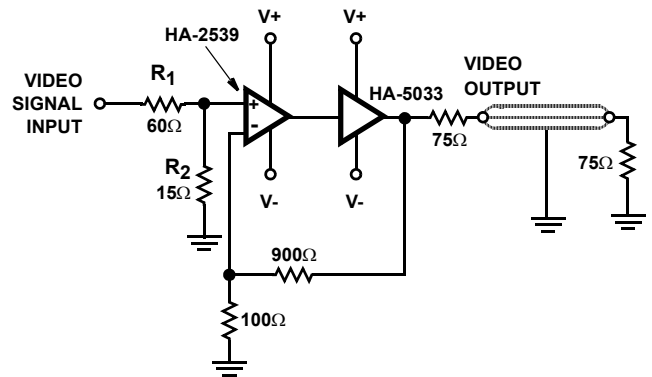
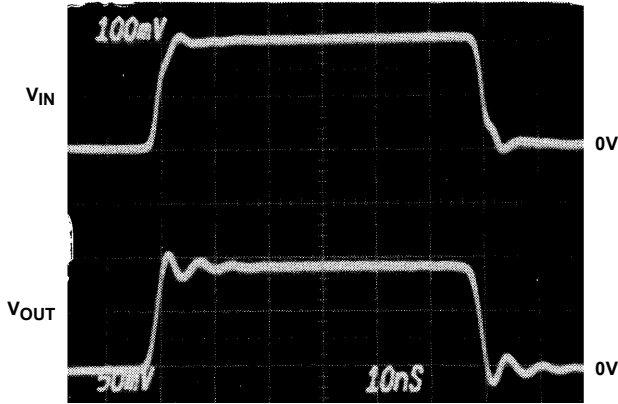

FIGURE 7. VIDEO GAIN BLOCK

**Typical Applications** (Also see Application Note AN548) (Continued)



$T_A = 25^\circ\text{C}, R_S = 50\Omega, R_M = R_L = 50\Omega$

$$V_O = V_{IN} \left[ \frac{R_L}{R_L + R_M} \right] = \left[ \frac{1}{2} \right] V_{IN}$$

**POSITIVE PULSE RESPONSE**

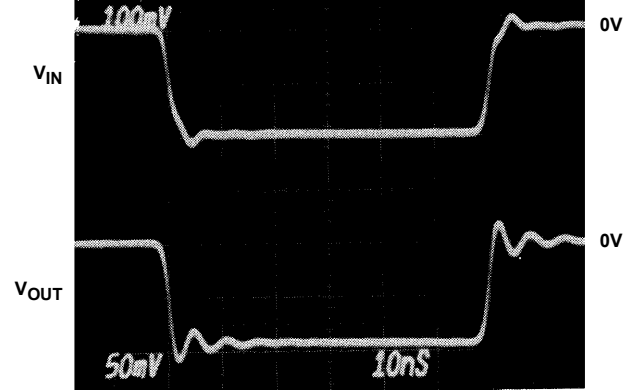

$T_A = 25^\circ\text{C}, R_S = 50\Omega, R_M = R_L = 50\Omega$

$$V_O = V_{IN} \left[ \frac{R_L}{R_L + R_M} \right] = \left[ \frac{1}{2} \right] V_{IN}$$

**NEGATIVE PULSE RESPONSE**

**Typical Performance Curves**

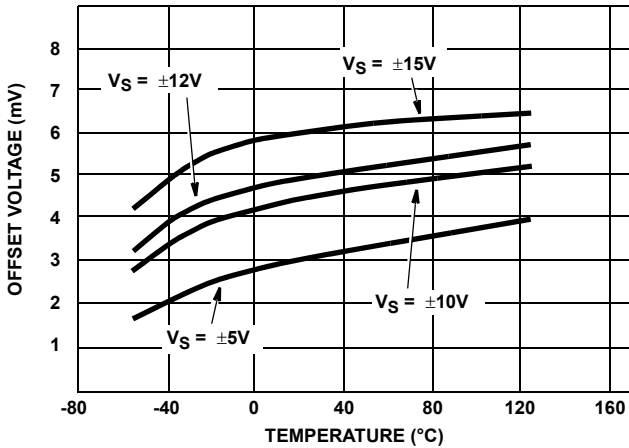

**FIGURE 8. INPUT OFFSET VOLTAGE vs TEMPERATURE**

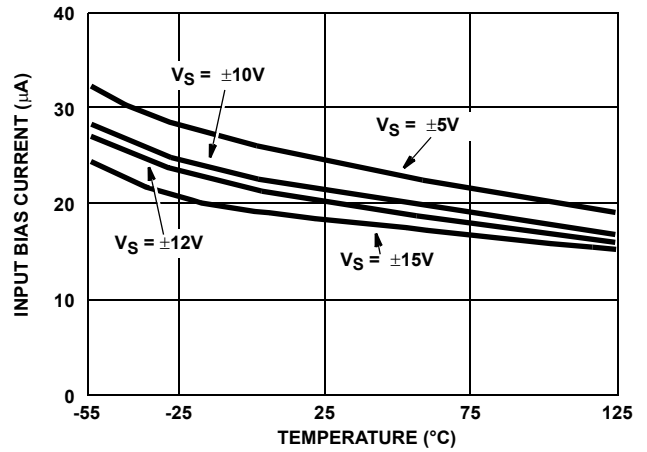

**FIGURE 9. INPUT BIAS CURRENT vs TEMPERATURE**

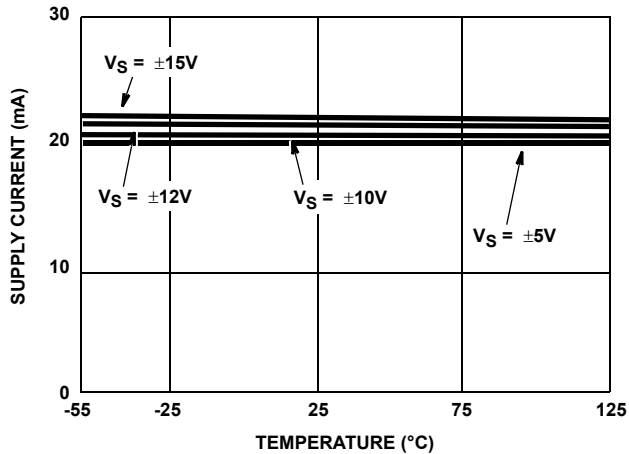

**FIGURE 10. SUPPLY CURRENT vs TEMPERATURE**

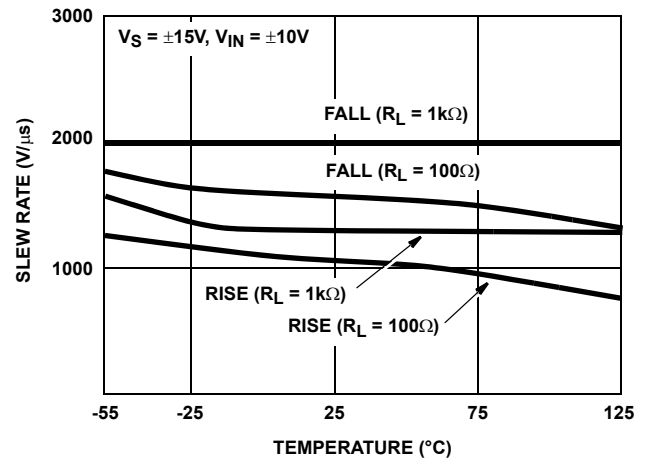

**FIGURE 11. SLEW RATE vs TEMPERATURE**

**Typical Performance Curves** (Continued)

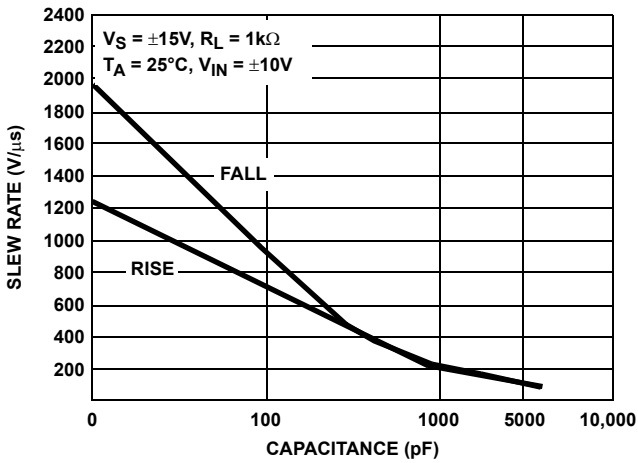

FIGURE 12. SLEW RATE vs LOAD CAPACITANCE

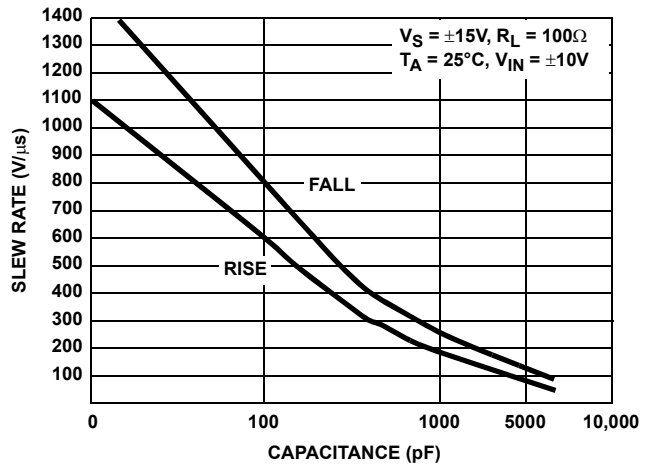

FIGURE 13. SLEW RATE vs LOAD CAPACITANCE

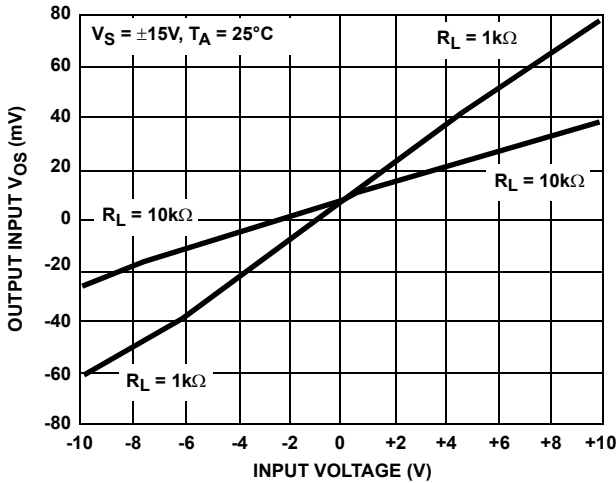

FIGURE 14. GAIN ERROR vs INPUT VOLTAGE

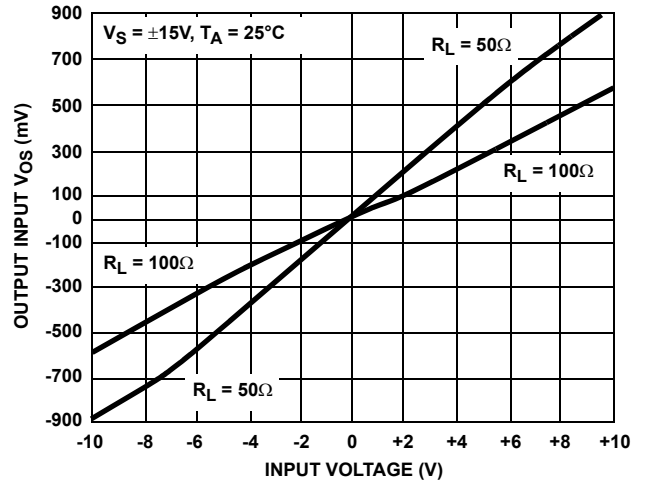

FIGURE 15. GAIN ERROR vs INPUT VOLTAGE

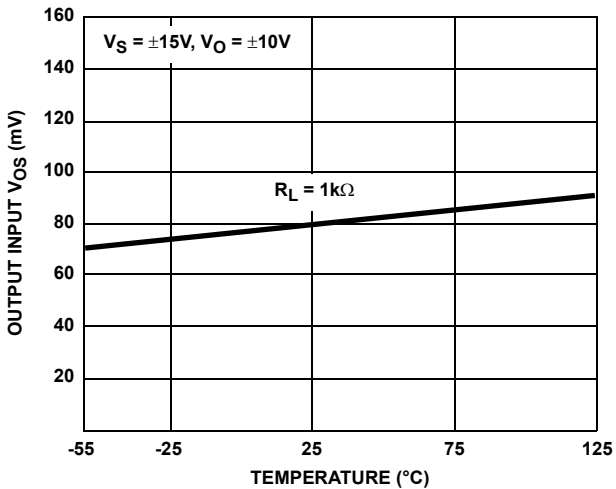

FIGURE 16. GAIN ERROR vs TEMPERATURE

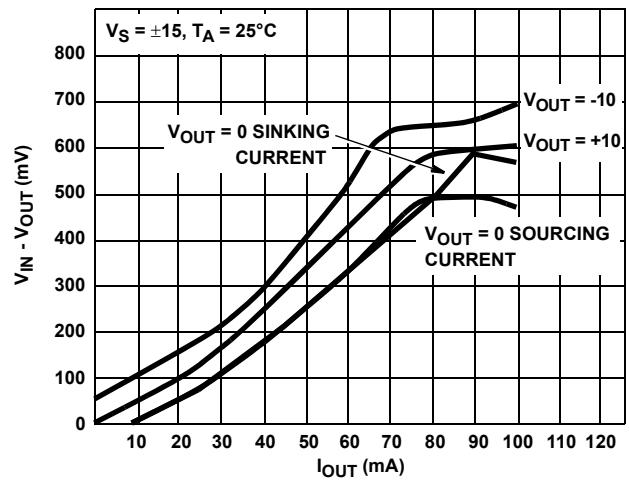

FIGURE 17.  $V_{IN} - V_{OUT}$  vs  $I_{OUT}$

**Typical Performance Curves** (Continued)

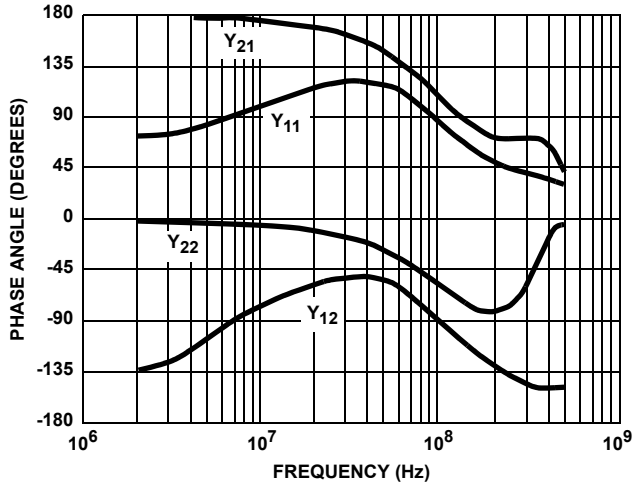

FIGURE 18. Y - PARAMETERS PHASE vs FREQUENCY

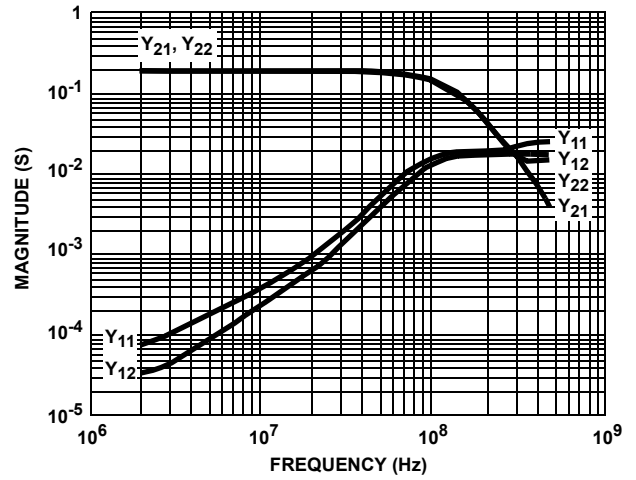

FIGURE 19. Y - PARAMETER MAGNITUDE vs FREQUENCY

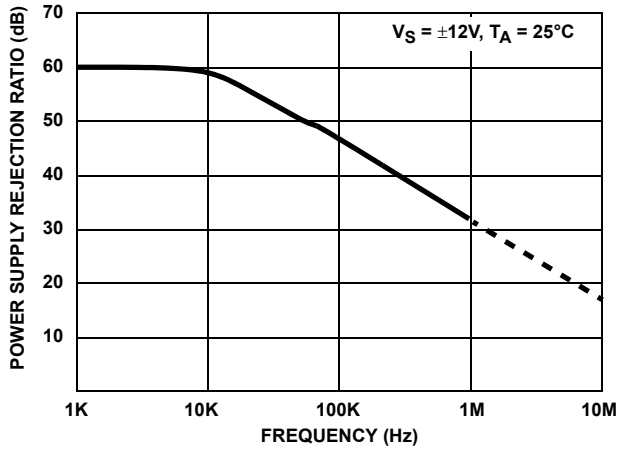

FIGURE 20. POWER SUPPLY REJECTION RATIO vs FREQUENCY

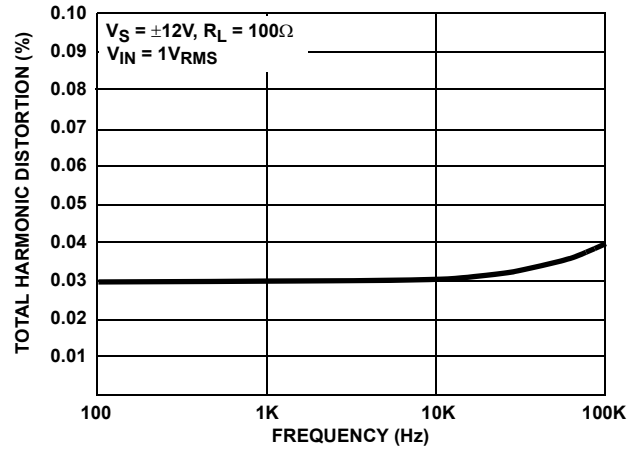

FIGURE 21. TOTAL HARMONIC DISTORTION vs FREQUENCY

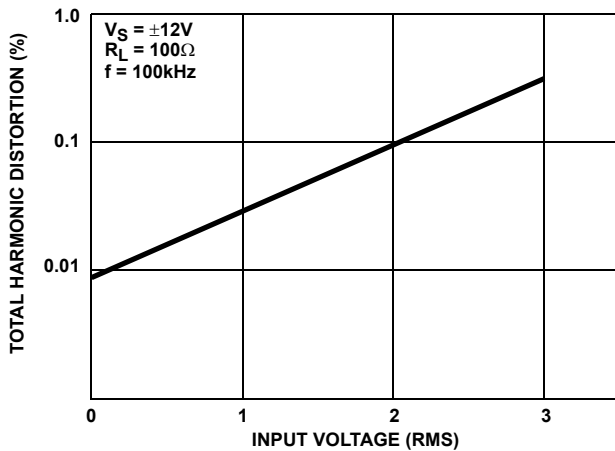

FIGURE 22. TOTAL HARMONIC DISTORTION vs INPUT VOLTAGE

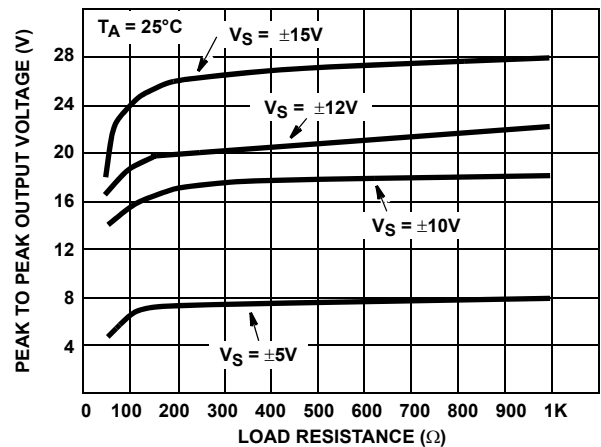
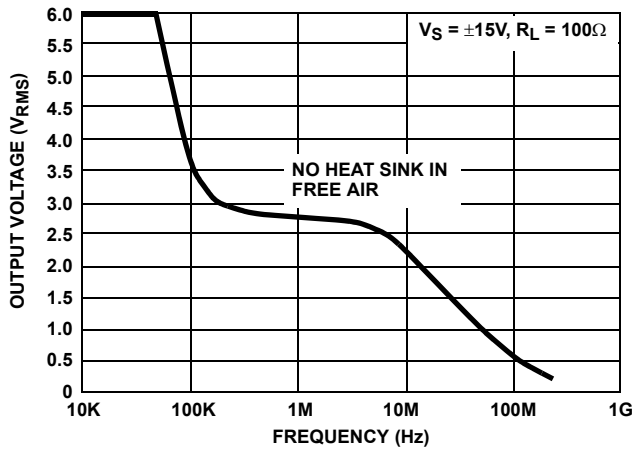

FIGURE 23. OUTPUT VOLTAGE SWING vs LOAD RESISTANCE



**Typical Performance Curves** (Continued)



**FIGURE 24. OUTPUT SWING vs FREQUENCY (NOTE)**

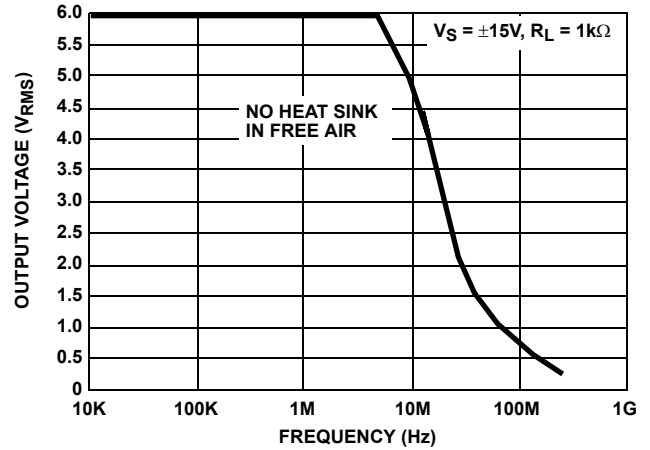

**FIGURE 25. OUTPUT SWING vs FREQUENCY (NOTE)**

**NOTE:**

This curve was obtained by noting the output voltage necessary to produce an observable distortion for a given frequency. If higher distortion is acceptable, then a higher output voltage for a given frequency can be obtained. However, operating the HA-5033 with increased distortion (to the right of curve shown), will also be accompanied by an increase in supply current. The resulting increase in chip temperature must be considered and heat sinking will be necessary to prevent thermal runaway. This characteristic is the result of the output transistor operation. If the signal amplitude or signal frequency or both are increased beyond the curve shown, the NPN, PNP output transistors will approach a condition of being simultaneously on. Under this condition, thermal runaway can occur.

**Die Characteristics**

**SUBSTRATE POTENTIAL (POWERED UP):**

Unbiased

**TRANSISTOR COUNT:**

20

**PROCESS:**

Bipolar Dielectric Isolation

**Metallization Mask Layout**

HA-5033

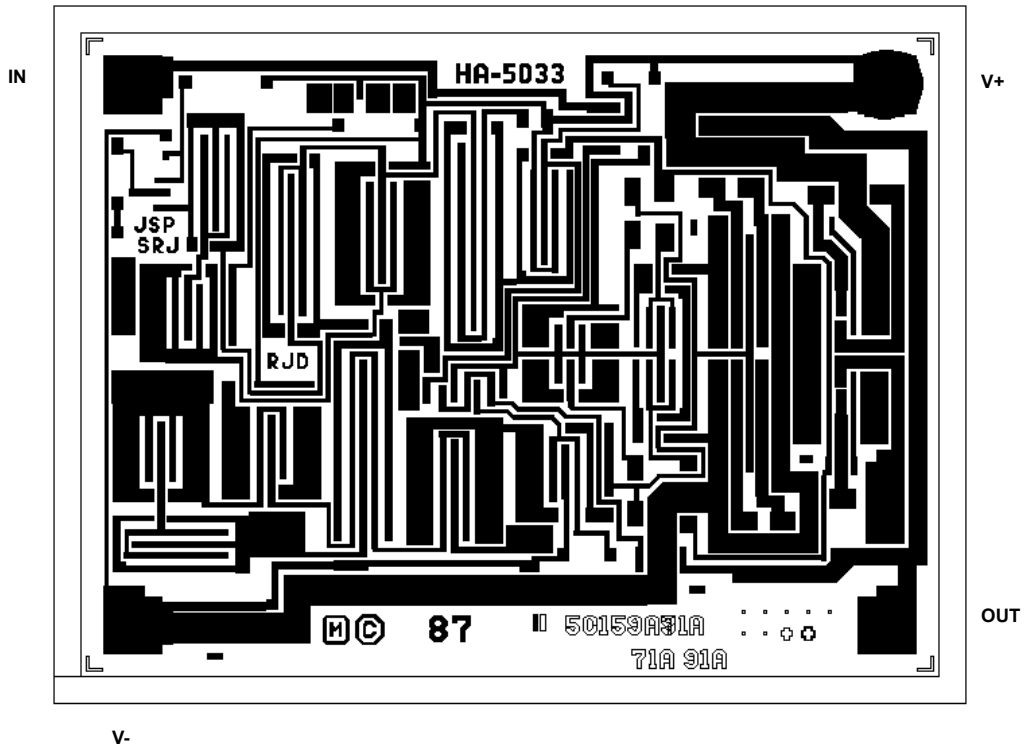

### Metal Can Packages (Can)

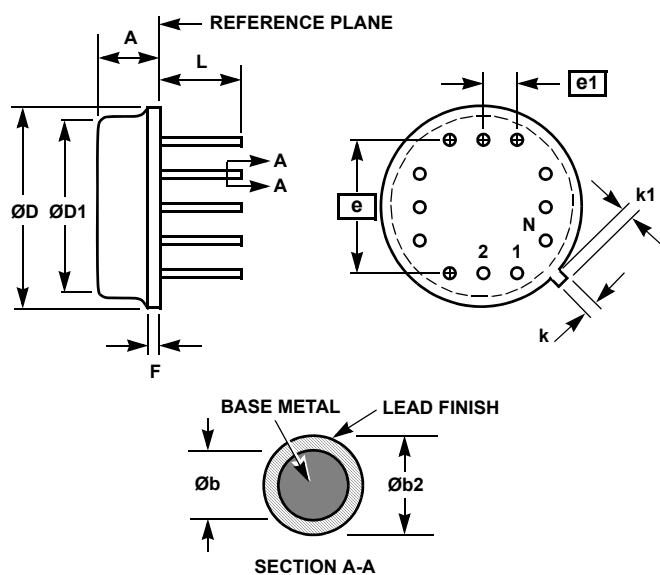

**T12.C**  
12 LEAD METAL CAN PACKAGE

SYMBOL	INCHES		MILLIMETERS		NOTES
	MIN	MAX	MIN	MAX	
A	0.130	0.150	3.30	3.81	-
Øb	0.016	0.019	0.41	0.48	-
Øb2	0.016	0.021	0.41	0.53	-
ØD	0.585	0.615	14.86	15.62	-
ØD1	0.540	0.560	13.72	14.22	-
e	0.400 BSC		10.16 BSC		-
e1	0.100 BSC		2.54 BSC		-
F	0.020	0.040	0.51	1.02	-
k	0.027	0.034	0.69	0.86	-
k1	0.027	0.045	0.69	1.14	2
L	0.500	0.560	12.70	14.22	-
N	12		12		3

Rev. 0 5/18/94

**NOTES:**

1. The reference, base, and seating planes are the same for this variation.
2. Measured from maximum diameter of the product.
3. N is the maximum number of terminal positions.
4. Dimensioning and tolerancing per ANSI Y14.5M - 1982.
5. Controlling dimension: INCH.

## Dual-In-Line Plastic Packages (PDIP)

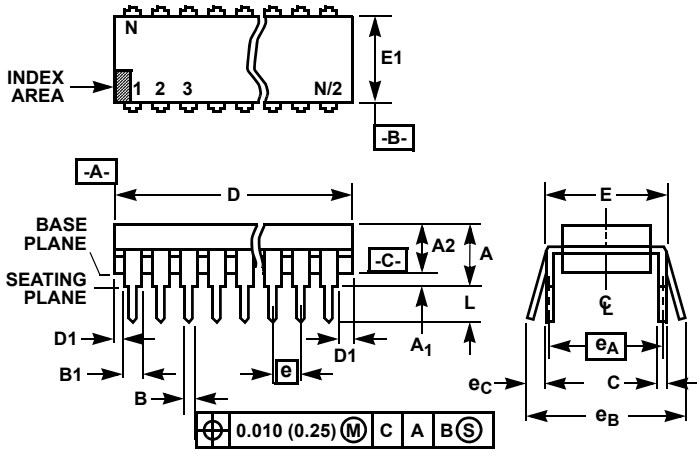

**NOTES:**

1. Controlling Dimensions: INCH. In case of conflict between English and Metric dimensions, the inch dimensions control.
2. Dimensioning and tolerancing per ANSI Y14.5M-1982.
3. Symbols are defined in the "MO Series Symbol List" in Section 2.2 of Publication No. 95.
4. Dimensions A, A1 and L are measured with the package seated in JEDEC seating plane gauge GS-3.
5. D, D1, and E1 dimensions do not include mold flash or protrusions. Mold flash or protrusions shall not exceed 0.010 inch (0.25mm).
6. E and  $e_A$  are measured with the leads constrained to be perpendicular to datum -C-.
7.  $e_B$  and  $e_C$  are measured at the lead tips with the leads unconstrained.  $e_C$  must be zero or greater.
8. B1 maximum dimensions do not include dambar protrusions. Dambar protrusions shall not exceed 0.010 inch (0.25mm).
9. N is the maximum number of terminal positions.
10. Corner leads (1, N, N/2 and N/2 + 1) for E8.3, E16.3, E18.3, E28.3, E42.6 will have a B1 dimension of 0.030 - 0.045 inch (0.76 - 1.14mm).

### E8.3 (JEDEC MS-001-BA ISSUE D) 8 LEAD DUAL-IN-LINE PLASTIC PACKAGE

SYMBOL	INCHES		MILLIMETERS		NOTES
	MIN	MAX	MIN	MAX	
A	-	0.210	-	5.33	4
A1	0.015	-	0.39	-	4
A2	0.115	0.195	2.93	4.95	-
B	0.014	0.022	0.356	0.558	-
B1	0.045	0.070	1.15	1.77	8, 10
C	0.008	0.014	0.204	0.355	-
D	0.355	0.400	9.01	10.16	5
D1	0.005	-	0.13	-	5
E	0.300	0.325	7.62	8.25	6
E1	0.240	0.280	6.10	7.11	5
e	0.100 BSC		2.54 BSC		-
$e_A$	0.300 BSC		7.62 BSC		6
$e_B$	-	0.430	-	10.92	7
L	0.115	0.150	2.93	3.81	4
N	8		8		9

Rev. 0 12/93

© Copyright Intersil Americas LLC 2003-2006. All Rights Reserved.  
All trademarks and registered trademarks are the property of their respective owners.

For additional products, see [www.intersil.com/en/products.html](http://www.intersil.com/en/products.html)

Intersil products are manufactured, assembled and tested utilizing ISO9001 quality systems as noted in the quality certifications found at [www.intersil.com/en/support/qualandreliability.html](http://www.intersil.com/en/support/qualandreliability.html)

Intersil products are sold by description only. Intersil may modify the circuit design and/or specifications of products at any time without notice, provided that such modification does not, in Intersil's sole judgment, affect the form, fit or function of the product. Accordingly, the reader is cautioned to verify that datasheets are current before placing orders. Information furnished by Intersil is believed to be accurate and reliable. However, no responsibility is assumed by Intersil or its subsidiaries for its use; nor for any infringements of patents or other rights of third parties which may result from its use. No license is granted by implication or otherwise under any patent or patent rights of Intersil or its subsidiaries.

For information regarding Intersil Corporation and its products, see [www.intersil.com](http://www.intersil.com)