

# DATA SHEET

## ARRAY CHIP RESISTORS

YC/TC  
5%, 1%

sizes

YC: 102/104/122/124/162/164/248/324/158T/358L/358T

TC: 122/124/164

RoHS compliant





**PHYCOMP BRAND ordering codes**

Both GLOBAL PART NUMBER (preferred) and I2NC (traditional) codes are acceptable to order Phycomp brand products.

**GLOBAL PART NUMBER (PREFERRED)**

For detailed information of GLOBAL PART NUMBER and ordering example, please refer to page 2. TC122 series is supplied and ordered by global part number only.

**I2NC CODE**

TYPE/ 2×0402	2350	XXX XXXXX L				PAPER / PE TAPE ON REEL (units) <sup>(2)</sup>	
	(1)	(2)	(3)	(4)	10,000	50,000	
ARV321	2350	±5%	1 to 1 MΩ		013 11xxx	013 12xxx	
ARV322	2350	±1%	10 to 1 MΩ		013 2xxxx	013 3xxxx	
Jumper	2350	-	0 Ω		013 91001	-	

Last digit of I2NC Resistance decade <sup>(3)</sup>	Last digit
0.01 to 0.0976 Ω	0
0.1 to 0.976 Ω	7
1 to 9.76 Ω	8
10 to 97.6 Ω	9
100 to 976 Ω	1
1 to 9.76 KΩ	2
10 to 97.6 KΩ	3
100 to 976 KΩ	4
1 to 9.76 MΩ	5
10 to 97.6 MΩ	6

- (1) The resistors have a 12-digit ordering code starting with 2350.
- (2) The subsequent 4 or 5 digits indicate the resistor tolerance and packaging.
- (3) The remaining 4 or 3 digits represent the resistance value with the last digit indicating the multiplier as shown in the table of "Last digit of I2NC".
- (4) "L" is optional symbol <sup>(Note)</sup>.

Example:

0.02 Ω	=	0200 or 200
0.3 Ω	=	3007 or 307
1 Ω	=	1008 or 108
33 KΩ	=	3303 or 333
10 MΩ	=	1006 or 106

**ORDERING EXAMPLE**

The ordering code of a ARV321 resistor, value 1,000Ω with ±5% tolerance, supplied in tape of 10,000 units per reel is: 235001311102(L) or YC122-JR-071KL.

**NOTE**

- 1. All our RSMD products are RoHS compliant. "LFP" of the internal 2D reel label mentions "Lead Free Process"
- 2. On customized label, "LFP" or specific symbol printed and the optional "L" at the end of GLOBAL PART NUMBER / I2NC can be added (both are on customer request)

**MARKING**

**YC102**

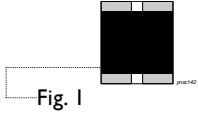

No marking

**YC122**

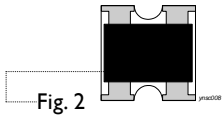

No marking

**YC104**

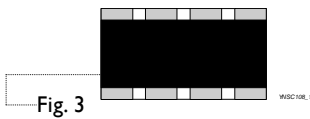

No marking

**YC124 / 162 / 164 / 324**

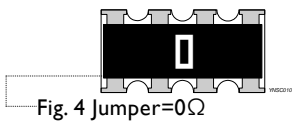

I-Digit marking

Fig. 4 Jumper=0Ω

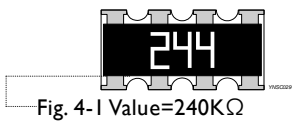

E-24 series: 3 digits, 5%  
First two digits for significant figure and 3rd digit for number of zeros

Fig. 4-I Value=240KΩ

**YC248**

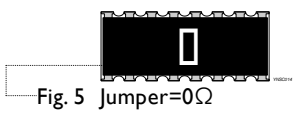

I-Digit marking

Fig. 5 Jumper=0Ω

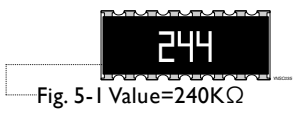

E-24 series: 3 digits, 5%  
First two digits for significant figure and 3rd digit for number of zeros

Fig. 5-I Value=240KΩ

**YC158T/358L/358T**

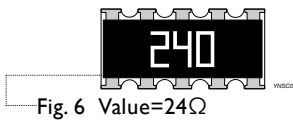

Fig. 6 Value=24Ω

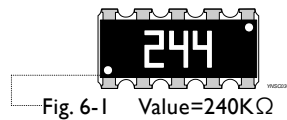
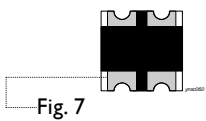

Fig. 6-I Value=240KΩ

E-24 series: 3 digits  
First two digits for significant figure and 3rd digit for number of zeros

**TC122**



No marking

Fig. 7

**TC124**

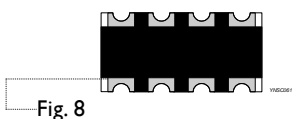

No marking

Fig. 8

TCI64



I-Digit marking

Fig. 9 Jumper=0Ω



E-24 series: 3 digits, 5%  
First two digits for significant figure and 3rd digit for number of zeros

Fig. 9-1 Value=240KΩ

For further marking information, please refer to data sheet “Chip resistors marking”.

**CONSTRUCTION**

The resistor is constructed on top of a high-grade ceramic body. Internal metal electrodes are added on each end to make the contacts to the thick film resistive element. The composition of the resistive element is a noble metal imbedded into a glass and covered by a second glass to prevent environment influences. The resistor is laser trimmed to the rated resistance value. The resistor is covered with a protective epoxy coat, finally the two external terminations (matte tin on Ni-barrier) are added as shown in Fig.9.

**OUTLINES**

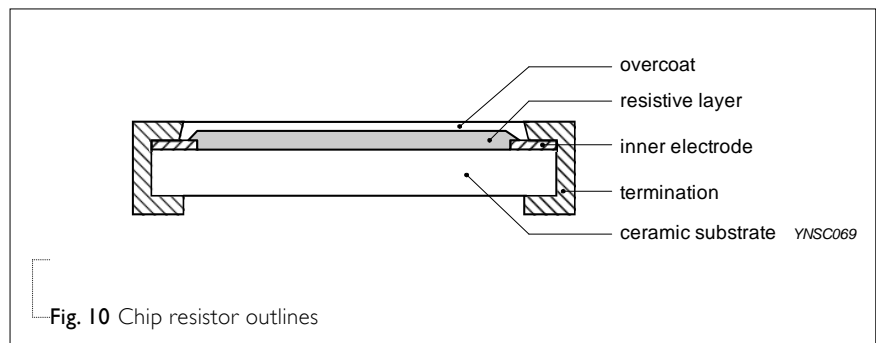

**SCHEMATIC**

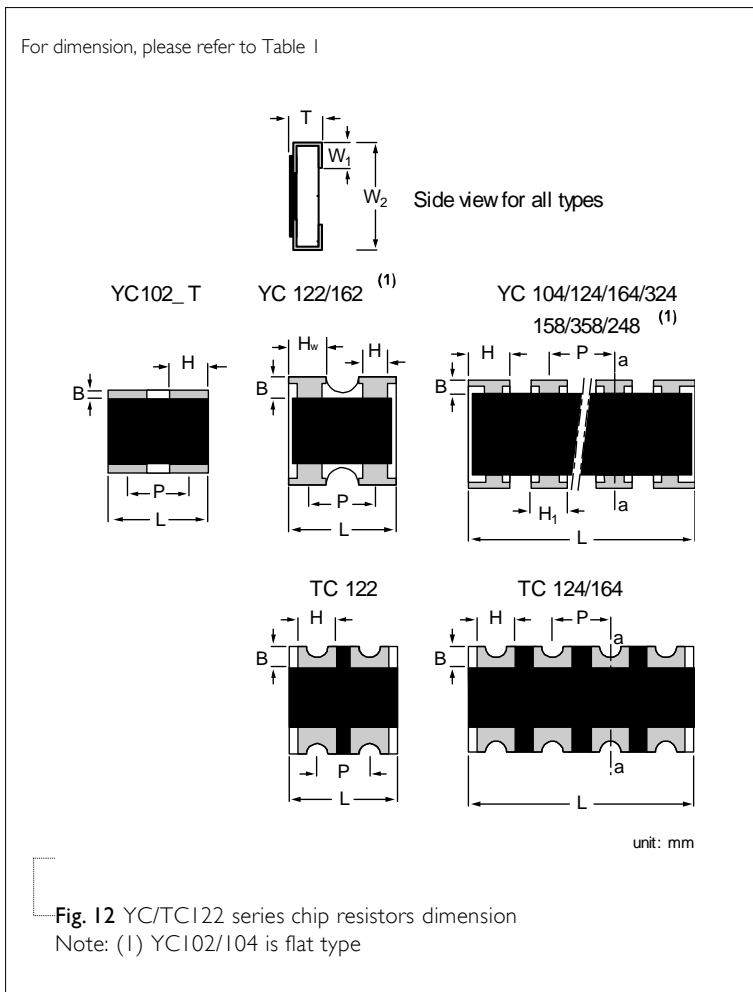
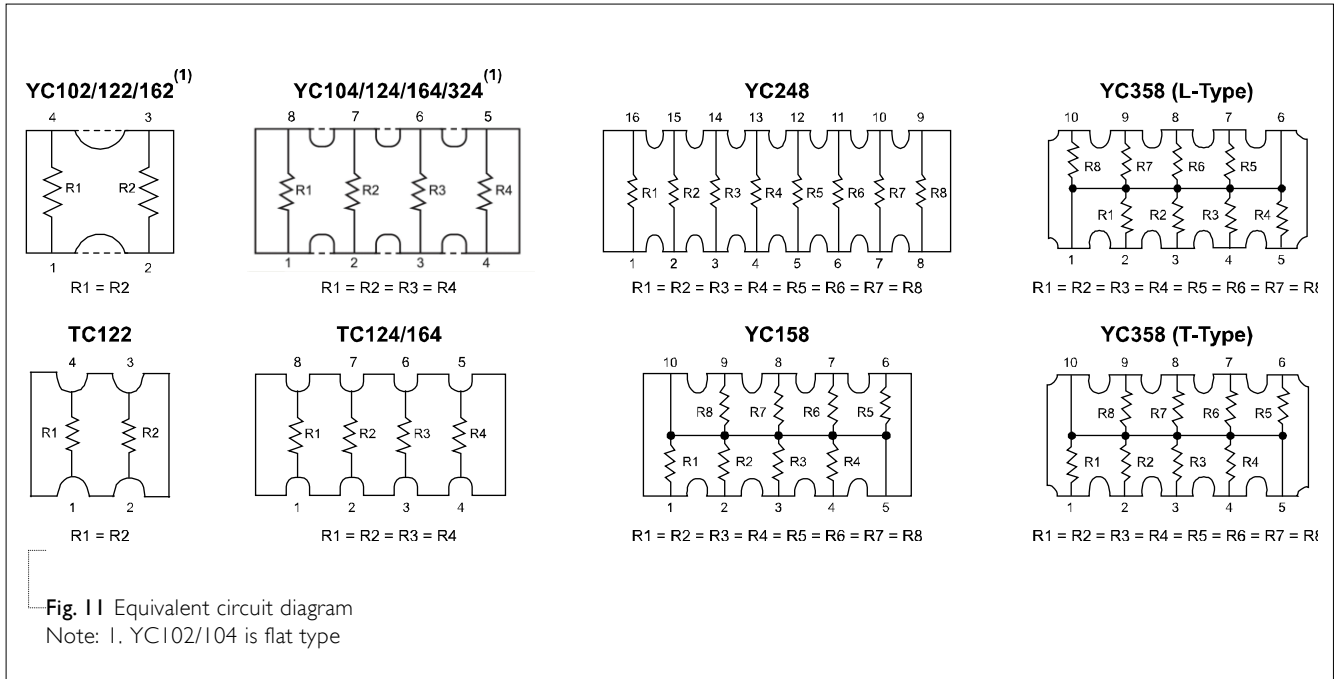

**DIMENSIONS**

Table I

TYPE	H / H <sub>I</sub> / H <sub>W</sub>	B	P	L	T	W1	W2
YC102	H: 0.25 ± 0.10	0.15 ± 0.10	0.55 ± 0.10	0.80 ± 0.10	0.35 ± 0.10	0.15 ± 0.10	0.60 ± 0.10
YC104	H: 0.20 ± 0.10	0.15 ± 0.05	0.40 ± 0.10	1.40 ± 0.10	0.35 ± 0.10	0.15 ± 0.10	0.60 ± 0.10
YC122	H: 0.21+0.10 / -0.05 H <sub>W</sub> : 0.35 ± 0.10	0.20 ± 0.10	0.67 ± 0.05	1.00 ± 0.10	0.30 ± 0.10	0.25 ± 0.10	1.00 ± 0.10
YC124	H: 0.40 ± 0.15 H <sub>I</sub> : 0.30 ± 0.05	0.20 ± 0.15	0.50 ± 0.05	2.00 ± 0.10	0.45 ± 0.10	0.30 ± 0.15	1.00 ± 0.10
YC162	H: 0.30 ± 0.10 H <sub>W</sub> : 0.65 ± 0.15	0.30 ± 0.10	0.80 ± 0.05	1.60 ± 0.10	0.40 ± 0.10	0.30 ± 0.10	1.60 ± 0.10
YC164	H: 0.65 ± 0.05 H <sub>I</sub> : 0.50 ± 0.15	0.30 ± 0.15	0.80 ± 0.05	3.20 ± 0.15	0.60 ± 0.10	0.30 ± 0.15	1.60 ± 0.15
YC248	H: 0.45 ± 0.05 H <sub>I</sub> : 0.30 ± 0.05	0.30 ± 0.15	0.50 ± 0.05	4.00 ± 0.20	0.45 ± 0.10	0.40 ± 0.15	1.60 ± 0.15
YC324	H: 1.10 ± 0.15 H <sub>I</sub> : 0.90 ± 0.15	0.50 ± 0.20	1.27 ± 0.05	5.08 ± 0.20	0.60 ± 0.10	0.50 ± 0.15	3.20 ± 0.20
TC122	H: 0.30 ± 0.05	0.25 ± 0.15	0.50 ± 0.05	1.00 ± 0.10	0.30 ± 0.10	0.25 ± 0.15	1.00 ± 0.10
TC124	H: 0.30 ± 0.10	0.20 ± 0.10	0.50 ± 0.05	2.00 ± 0.10	0.40 ± 0.10	0.25 ± 0.10	1.00 ± 0.10
TC164	H: 0.50 ± 0.15	0.30 ± 0.15	0.80 ± 0.05	3.20 ± 0.15	0.60 ± 0.10	0.30 ± 0.15	1.60 ± 0.15
YC158T	H: 0.45 ± 0.05 H <sub>I</sub> : 0.32 ± 0.05	0.30 ± 0.15	0.64 ± 0.05	3.20 ± 0.20	0.60 ± 0.10	0.35 ± 0.15	1.60 ± 0.15
YC358L	H: 1.10 ± 0.15	0.50 ± 0.15	1.27 ± 0.05	6.40 ± 0.20	0.60 ± 0.10	0.50 ± 0.15	3.20 ± 0.20
YC358T	H <sub>I</sub> : 0.90 ± 0.15						

**ELECTRICAL CHARACTERISTICS**

Table 2

TYPE	POWER P <sub>70</sub>	OPERATING TEMP. RANGE	MWV	RCOV	DWV	RESISTANCE RANGE & TOLERANCE	T. C. R.	Jumper criteria (unit: A)
YC102	1/32W	-55°C to +125°C	15V	30V	30V	E24 ±5% 10Ω ≤ R ≤ 1MΩ E24/E96 ±1% 10Ω ≤ R ≤ 1MΩ Jumper < 0.05Ω	±200 ppm/°C	Rated current 0.5 Max. current 1.0
YC104	1/32W	-55°C to +125°C	12.5V	25V	25V	E24 ±5% 10Ω ≤ R ≤ 1MΩ E24/E96 ±1% 10Ω ≤ R ≤ 1MΩ Jumper < 0.05Ω		Rated current 0.5 Max. current 1.0
YC122	1/16W	-55°C to +155°C	50V	100V	100V	E24 ±5% 1Ω ≤ R ≤ 1MΩ E24/E96 ±1% 1Ω ≤ R ≤ 1MΩ Jumper < 0.05Ω	1Ω ≤ R ≤ 10Ω ±250 ppm/°C 10Ω ≤ R ≤ 1MΩ ±200 ppm/°C	Rated current 0.5 Max. current 1.0
YC124	1/16W	-55°C to +155°C	25V	50V	100V	E24 ±5% 1Ω ≤ R ≤ 1MΩ E24/E96 ±1% 1Ω ≤ R ≤ 1MΩ Jumper < 0.05Ω		Rated current 1.0 Max. current 2.0
YC162	1/16W	-55°C to +155°C	50V	100V	100V	E24 ±5% 1Ω ≤ R ≤ 1MΩ E24/E96 ±1% 1Ω ≤ R ≤ 1MΩ Jumper < 0.05Ω	±200 ppm/°C	Rated current 1.0 Max. current 2.0
YC164	1/16W	-55°C to +155°C	50V	100V	100V	E24 ±5% 1Ω ≤ R ≤ 1MΩ E24/E96 ±1% 1Ω ≤ R ≤ 1MΩ Jumper < 0.05Ω		Rated current 1.0 Max. current 2.0
YC248	1/16W	-55°C to +155°C	50V	100V	100V	E24 ±5% 10Ω ≤ R ≤ 1MΩ E24/E96 ±1% 10Ω ≤ R ≤ 1MΩ Jumper < 0.05Ω	±200 ppm/°C	Rated current 2.0 Max. current 10.0
YC324	1/8W	-55°C to +155°C	200V	500V	500V	E24 ±5% 10Ω ≤ R ≤ 1MΩ E24/E96 ±1% 10Ω ≤ R ≤ 1MΩ		---
TC122	1/16W	-55°C to +125°C	50V	100V	100V	E24 ±5% 10Ω ≤ R ≤ 1MΩ E24/E96 ±1% 10Ω ≤ R ≤ 1MΩ Jumper < 0.05Ω	±200 ppm/°C	Rated current 1.0 Max. current 1.5
TC124	1/16W	-55°C to +125°C	50V	100V	100V	E24 ±5% 10Ω ≤ R ≤ 1MΩ E24/E96 ±1% 10Ω ≤ R ≤ 1MΩ Jumper < 0.05Ω		Rated current 1.0 Max. current 1.5
TC164	1/16W	-55°C to +155°C	50V	100V	100V	E24 ±5% 10Ω ≤ R ≤ 1MΩ E24/E96 ±1% 10Ω ≤ R ≤ 1MΩ Jumper < 0.05Ω	±200 ppm/°C	Rated current 1.0 Max. current 2.0
YC158T	1/16W	-55°C to +155°C	25V	50V	50V	E24 ±5% 10Ω ≤ R ≤ 100KΩ		---
YC358L YC358T	1/16W	-55°C to +155°C	50V	100V	100V	E24 ±5% 10Ω ≤ R ≤ 330KΩ	---	---

**FOOTPRINT AND SOLDERING PROFILES**

For recommended footprint and soldering profiles, please refer to data sheet “Chip resistors mounting”.

**PACKING STYLE AND PACKAGING QUANTITY**

Table 3 Packing style and packaging quantity

PACKING STYLE	PACKING STYLE	YC102/ 104	YC/TC 122	YC/TC 124	YC162	YC/TC 164	YC248	YC324	YC158T	YC358L YC358T
Paper taping reel ( R )	7" (178mm)	10,000	10,000	10,000	5,000	5,000	5,000	---	5,000	---
	13" (254mm)	50,000	50,000	40,000	---	20,000	---	---	20,000	---
Embossed taping reel ( K )	7" (178mm)	---	---	---	---	---	4,000	4,000	---	4,000

**NOTE**

I. For tape and reel specification/dimensions, please refer to data sheet “Chip resistors packing”.



**FUNCTIONAL DESCRIPTION**

**OPERATING TEMPERATURE RANGE**

YC102/104, TC122/124 Range:

-55°C to +125°C (Fig.13)

YC122/124/162/164/248/324/158T/358L/358T, TC164

Range:

-55°C to +155°C(Fig.14)

**POWER RATING**

Each type rated power at 70°C

YC102/104 = 1/32 W

YC122/124/162/164/248/158T/358L/358T = 1/16 W

YC324 = 1/8 W

TC122/124/164 = 1/16 W

**RATED VOLTAGE**

The DC or AC (rms) continuous working voltage corresponding to the rated power is determined by the following formula:

$$V = \sqrt{P \times R}$$

or max. working voltage whichever is less

Where

V=Continuous rated DC or AC (rms) working voltage (V)

P=Rated power (W)

R=Resistance value ( $\Omega$ )

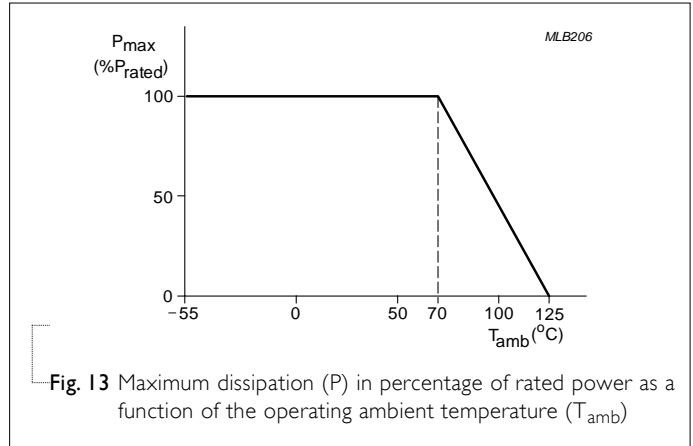

**TESTS AND REQUIREMENTS**
**Table 4** Test condition, procedure and requirements

TEST	TEST METHOD	PROCEDURE	REQUIREMENTS
Life/ Operational Life/ Endurance	MIL-STD-202-method 108	1,000 hours at 70±5 °C applied RCWV	±(2%+0.05 Ω)
	IEC 60115-1 4.25.1	1.5 hours on, 0.5 hour off, still air required	<100 mΩ for Jumper
	JIS C 5202-7.10		
High Temperature Exposure/ Endurance at Upper Category Temperature	MIL-STD-202-method 108	1,000 hours at maximum operating	±(1%+0.05 Ω)
	IEC 60115-1 4.25.3	temperature depending on specification, unpowered	<50 mΩ for Jumper
	JIS C 5202-7.11	No direct impingement of forced air to the parts Tolerances: 125±3 °C	
Moisture Resistance	MIL-STD-202-method 106	Each temperature / humidity cycle is defined at	±(2%+0.05 Ω)
	IEC 60115-1 4.24.2	8 hours (method 106F), 3 cycles / 24 hours for 10d with 25 °C / 65 °C 95% R.H, without steps 7a & 7b, unpowered	<100 mΩ for Jumper
		Parts mounted on test-boards, without condensation on parts Measurement at 24±2 hours after test conclusion	
Thermal Shock	MIL-STD-202-method 107	-55/+125 °C	±(1%+0.05 Ω)
		Note: Number of cycles required is 300. Devices mounted	<50 mΩ for Jumper
		Maximum transfer time is 20 seconds. Dwell time is 15 minutes. Air – Air	
Short Time Overload	MIL-R-55342-para 4.7.5	2.5 times RCWV or maximum overload	±(2%+0.05 Ω)
	IEC60115-1 4.13	voltage whichever is less for 5 sec at room temperature	<50 mΩ for Jumper No visible damage
Board Flex/ Bending	IEC60115-1 4.33	Device mounted on PCB test board as described, only 1 board bending required	±(1%+0.05 Ω)
		3 mm bending	<50 mΩ for Jumper
		Bending time: 60±5 seconds Ohmic value checked during bending	No visible damage

TEST	TEST METHOD	PROCEDURE	REQUIREMENTS
Solderability - Wetting	J-STD-002 test	Electrical Test not required	Well tinned ( $\geq 95\%$ covered) No visible damage
		Magnification 50X SMD conditions: 1 <sup>st</sup> step: method B, aging 4 hours at 155 °C dry heat 2 <sup>nd</sup> step: leadfree solder bath at 245±3 °C Dipping time: 3±0.5 seconds	
- Leaching	J-STD-002 test	Leadfree solder, 260 °C, 30 seconds immersion time	No visible damage
- Resistance to Soldering Heat	MIL-STD-202-method 210	Condition B, no pre-heat of samples Leadfree solder, 260 °C, 10 seconds immersion time Procedure 2 for SMD: devices fluxed and cleaned with isopropanol	±(1%+0.05 Ω) <50 mΩ for Jumper No visible damage
Biased Humidity	AEC-Q200 Test 7	1,000 hours; 85 °C / 85% RH 10% of operating power Measurement at 24± 4 hours after test conclusion.	± (5.0%+0.05 Ω)
	MIL-STD-202-Method 103		

**REVISION HISTORY**

REVISION	DATE	CHANGE NOTIFICATION	DESCRIPTION
Version 9	Feb.19, 2019	-	- Update H dimension for YC124
Version 8	Dec. 24, 2018	-	- Update AEC-Q200 qualified
Version 7	Aug. 22, 2017	-	- Correct the typo for YC158T/358L/358T, Marking, "240" is 24ohm
Version 6	Jun. 1, 2017	-	- Update ordering information for networks YC158T/YC358L/YC358T
Version 5	Feb. 14, 2017	-	- Update YC158 and 358 part number to YC158T , YC358L and YC358T
Version 4	Dec. 22, 2016	-	- Delete YC102 default code L type
Version 3	Apr. 29, 2016	-	- Update YC series and TC164 dimension
Version 2	Dec. 11, 2015	-	- Update Operating Temperature
Version 1	Feb. 04, 2015	-	- Update YC102 to flat type
Version 0	Nov. 14, 2014	-	- First issue of this specification

*“ Yageo reserves all the rights for revising the content of this datasheet without further notification, as long as the products itself are unchanged. Any product change will be announced by PCN.”*