

Low Dropout Regulator, Ultra High Accuracy, Low I_q, 500 mA with Power Good

NCP3337

The NCP3337 is a high performance, low dropout regulator. With accuracy of $\pm 0.9\%$ over line and load and ultra-low quiescent current and noise it encompasses all of the necessary features required by today's consumer electronics. This unique device is guaranteed to be stable without a minimum load current requirement and stable with any type of capacitor as small as 1.0 μF . The NCP3337 also comes equipped with sense and noise reduction pins to increase the overall utility of the device. The NCP3337 offers reverse bias protection.

Features

- High Accuracy Over Line and Load ($\pm 0.9\%$ at 25°C)
- Ultra-Low Dropout Voltage at Full Load (260 mV typ)
- No Minimum Output Current Required for Stability
- Low Noise (33 μVrms w/10 nF C_{nr} and 52 μVrms w/out C_{nr})
- Low Shutdown Current (< 1 mA)
- Reverse Bias Protected
- 2.9 V to 12 V Supply Range
- Thermal Shutdown Protection
- Current Limitation
- Requires Only 1.0 μF Output Capacitance for Stability
- Stable with Any Type of Capacitor (including MLCC)
- Available in 1.8 V, 2.5 V, 3.3 V, 5.0 V and Adjustable Output Voltages
- Power Good Output
- These are Pb-Free Devices

Applications

- PCMCIA Card
- Cellular Phones
- Camcorders and Cameras
- Networking Systems, DSL/Cable Modems
- Cable Set-Top Box
- MP3/CD Players
- DSP Supply
- Displays and Monitors



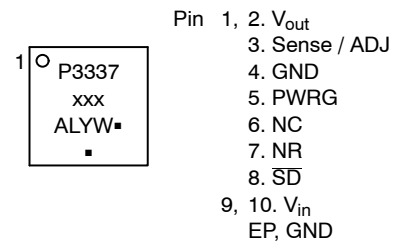
ON Semiconductor®

www.onsemi.com



DFN10
MN SUFFIX
CASE 485C

MARKING DIAGRAM



xxx = Specific Device Marking
A = Assembly Location
L = Wafer Lot
Y = Year
W = Work Week
▪ = Pb-Free Package

(Note: Microdot may be in either location)

ORDERING INFORMATION

See detailed ordering, marking and shipping information in the package dimensions section on page 15 of this data sheet.

NCP3337

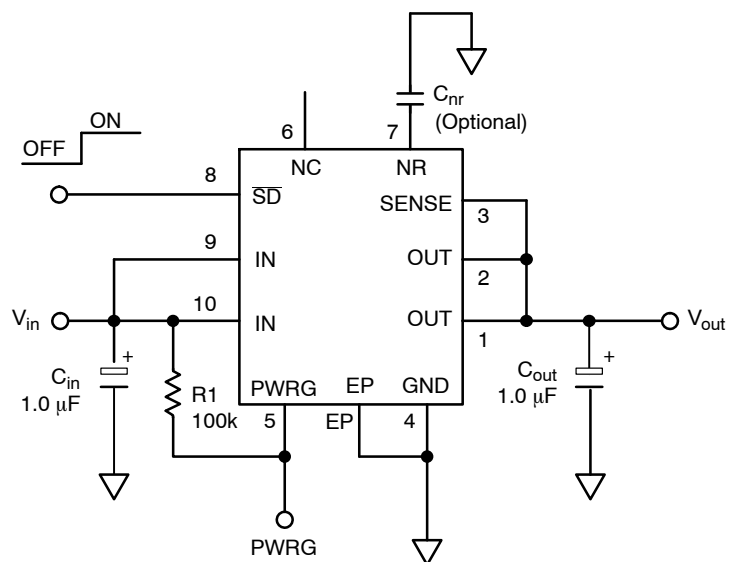


Figure 1. Typical Fixed Version Application Schematic

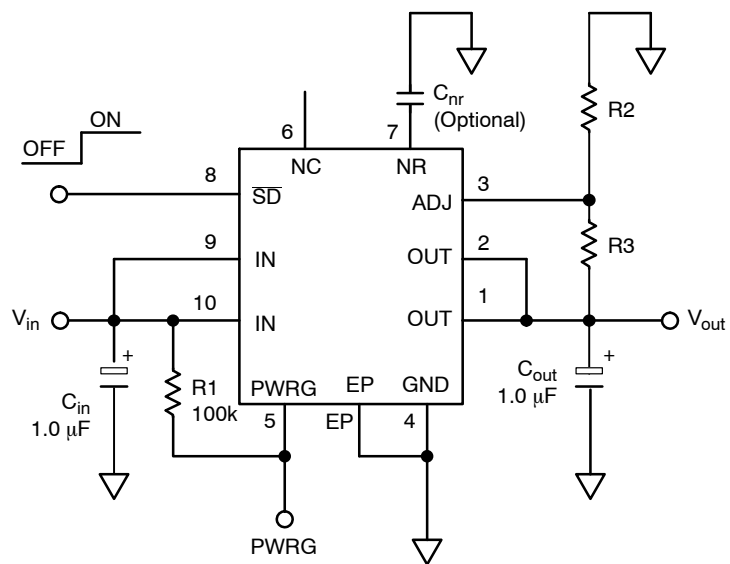


Figure 2. Typical Adjustable Version Application Schematic

NCP3337

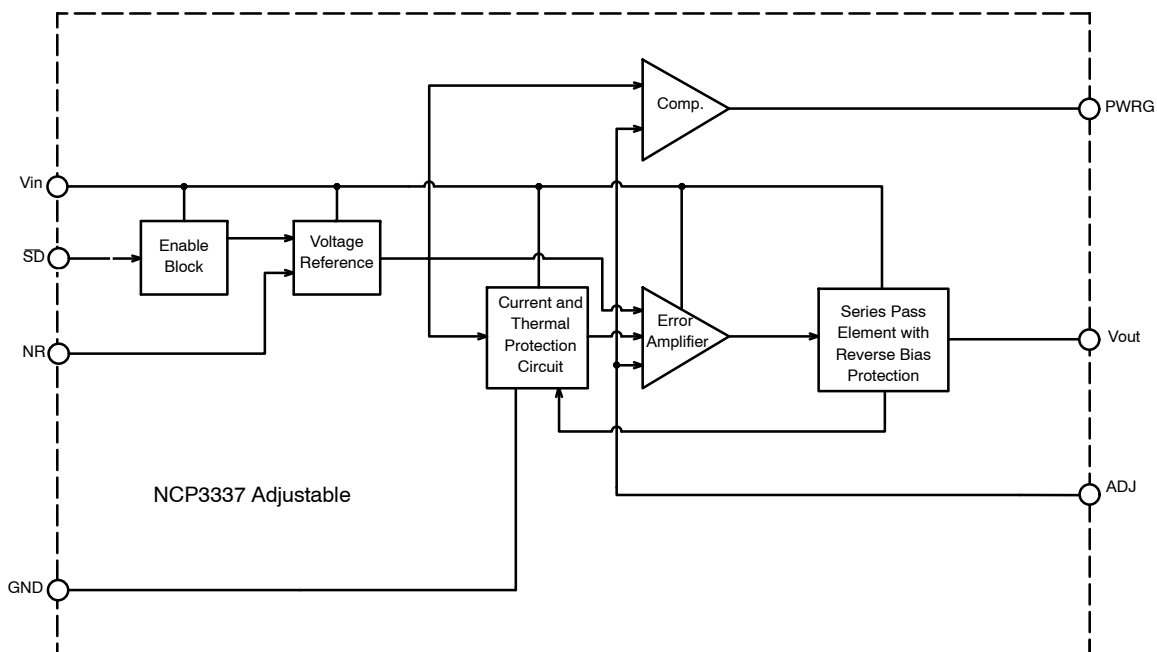


Figure 3. Block Diagram, Adjustable Output Version

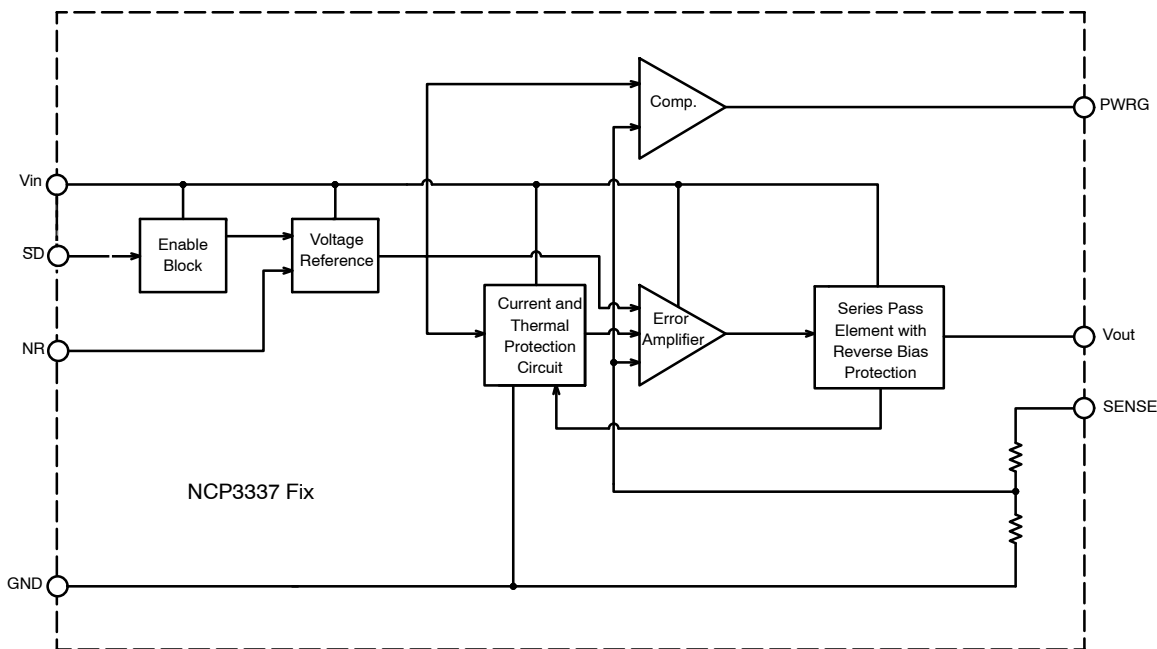


Figure 4. Block Diagram, Fixed Output Version

NCP3337

PIN FUNCTION DESCRIPTION

| Pin No. | Pin Name | Description |
|---------|------------------|---|
| 1, 2 | V _{out} | Regulated output voltage. Bypass to ground with C _{out} ≥ 1.0 μF |
| 3 | SENSE/ADJ | For output voltage sensing, connect to Pins 1 and 2. at Fixed output Voltage version Adjustable pin at Adjustable output version |
| 4 | GND | Power Supply Ground |
| 5 | PWRG | Power Good |
| 6 | NC | Not Connected |
| 7 | NR | Noise Reduction Pin. This is an optional pin used to further reduce noise. |
| 8 | \overline{SD} | Shutdown pin. When not in use, this pin should be connected to the input pin. |
| 9, 10 | V _{in} | Power Supply Input Voltage |
| EPAD | EPAD | Exposed thermal pad should be connected to ground. |

MAXIMUM RATINGS

| Rating | Symbol | Value | Unit |
|----------------------------|-------------------|---------------------------------------|------|
| Input Voltage | V _{in} | -0.3 to +16 | V |
| Output Voltage | V _{out} | -0.3 to V _{in} +0.3 or 10 V* | V |
| PWRG Pin Voltage | V _{PWRG} | -0.3 to +16 | V |
| Shutdown Pin Voltage | V _{sh} | -0.3 to +16 | V |
| Junction Temperature Range | T _J | -40 to +150 | °C |
| Storage Temperature Range | T _{stg} | -50 to +150 | °C |

Stresses exceeding those listed in the Maximum Ratings table may damage the device. If any of these limits are exceeded, device functionality should not be assumed, damage may occur and reliability may be affected.

NOTE: This device series contains ESD protection and exceeds the following tests:

Human Body Model (HBM) JESD 22-A114-B

Machine Model (MM) JESD 22-A115-A

*Which ever is less. Reverse bias protection feature valid only if (V_{out} - V_{in}) ≤ 7 V.

THERMAL CHARACTERISTICS

| Characteristic | Test Conditions (Typical Value) | | Unit |
|----------------------------------|---------------------------------|-----------------------|------|
| | Min Pad Board (Note 1) | 1" Pad Board (Note 1) | |
| Junction-to-Air, θ _{JA} | 215 | 66 | °C/W |
| Junction-to-Pin, J-L4 | 58 | 18 | °C/W |

1. As mounted on a 35 x 35 x 1.5 mm FR4 Substrate, with a single layer of a specified copper area of 2 oz (0.07 mm thick) copper traces and heat spreading area. JEDEC 51 specifications for a low and high conductivity test board recommend a 2 oz copper thickness. Test conditions are under natural convection or zero air flow.

NCP3337

ELECTRICAL CHARACTERISTICS – 5 V ($V_{out} = 5.0$ V typical, $V_{in} = 5.4$ V, $T_A = -40^{\circ}\text{C}$ to $+85^{\circ}\text{C}$, unless otherwise noted, Note 2)

| Characteristic | Symbol | Min | Typ | Max | Unit |
|--|--|-----------------|----------------------|-------------------------------------|---|
| Output Voltage (Accuracy) $V_{in} = 5.4$ V to 7.3 V, $I_{load} = 0.1$ mA to 500 mA, $T_A = 25^{\circ}\text{C}$ | V_{out} | -0.90% 4.955 | 5 | 0.90% 5.045 | V |
| Output Voltage (Accuracy) $V_{in} = 5.4$ V to 7.3 V, $I_{load} = 0.1$ mA to 500 mA, $T_A = 0^{\circ}\text{C}$ to $+85^{\circ}\text{C}$ | V_{out} | -1.40% 4.930 | 5 | 1.40% 5.070 | V |
| Output Voltage (Accuracy) $V_{in} = 5.4$ V to 7.3 V, $I_{load} = 0.1$ mA to 500 mA, $T_A = -40^{\circ}\text{C}$ to $+125^{\circ}\text{C}$ | V_{out} | -1.50% 4.925 | 5 | 1.50% 5.075 | V |
| Line Regulation $V_{in} = 5.4$ V to 12 V, $I_{load} = 0.1$ mA | LineReg | | 0.04 | | mV/V |
| Load Regulation $V_{in} = 5.4$ V, $I_{load} = 0.1$ mA to 500 mA | LoadReg | | 0.04 | | mV/mA |
| Dropout Voltage (See Application Note) $I_{load} = 500$ mA $I_{load} = 300$ mA $I_{load} = 50$ mA $I_{load} = 0.1$ mA | V_{DO} | | | 340 230 110 10 | mV |
| Peak Output Current (See Figure 14) | I_{pk} | 500 | 700 | 830 | mA |
| Short Output Current (See Figure 14) $V_{in} < 7$ V, $T_A = 25^{\circ}\text{C}$ | I_{sc} | | | 930 | mA |
| Thermal Shutdown / Hysteresis | T_J | | 160/10 | | $^{\circ}\text{C}$ |
| Ground Current In Regulation $I_{load} = 500$ mA (Note 4) $I_{load} = 300$ mA (Note 4) $I_{load} = 50$ mA $I_{load} = 0.1$ mA In Dropout $V_{in} = 3.2$ V, $I_{load} = 0.1$ mA In Shutdown $V_{SD} = 0$ V | I_{GND} I_{GNDsh} | | 9 4.6 0.8 - | 14 7.5 2.5 220 500 1 | mA μA |
| Output Noise $C_{nr} = 0$ nF, $I_{load} = 500$ mA, $f = 10$ Hz to 100 kHz, $C_{out} = 10$ μF $C_{nr} = 10$ nF, $I_{load} = 500$ mA, $f = 10$ Hz to 100 kHz, $C_{out} = 10$ μF | V_{noise} | | 93 58 | | μVrms |
| Power Good Voltage Low Threshold Hysteresis High Threshold | V_{elft} | 93 | 95 2 97 | 99 | % of V_{out} |
| Power Good Pin Voltage Saturation ($I_{ef} = 1.0$ mA) | V_{efdo} | | 200 | | mV |
| Power Good Pin Leakage | I_{efleak} | | 1 | | μA |
| Power Good Blanking Time (Note 3) | t_{ef} | | 50 | | μs |
| Shutdown Threshold Voltage ON Threshold Voltage OFF | V_{SD} | 2 | | 0.4 | V |
| SD Input Current, $V_{SD} = 0$ V to 0.4 V or $V_{SD} = 2.0$ V to V_{in} | I_{SD} | | 0.07 | 1 | μA |
| Output Current In Shutdown Mode, $V_{out} = 0$ V | I_{OSD} | | 0.07 | 1 | μA |
| Reverse Bias Protection, Current Flowing from the Output Pin to GND ($V_{in} = 0$ V, $V_{out_forced} = 5$ V) | I_{OUTR} | | 10 | | μA |

- Performance guaranteed over the operating temperature range by design and/or characterization, production tested at $T_J = T_A = 25^{\circ}\text{C}$. Low duty cycle pulse techniques are used during testing to maintain the junction temperature as close to ambient as possible.
- Can be disabled per customer request.
- T_A must be greater than 0°C .

NCP3337

ELECTRICAL CHARACTERISTICS – 3.3 V ($V_{out} = 3.3\text{ V}$ typical, $V_{in} = 3.7\text{ V}$, $T_A = -40^\circ\text{C}$ to $+85^\circ\text{C}$, unless otherwise noted, Note 5)

| Characteristic | Symbol | Min | Typ | Max | Unit |
|---|--|-----------------|-------------------------|---|---|
| Output Voltage (Accuracy) $V_{in} = 3.7\text{ V}$ to 7.3 V , $I_{load} = 0.1\text{ mA}$ to 500 mA , $T_A = 25^\circ\text{C}$ | V_{out} | -0.90% 3.270 | 3.3 | 0.90% 3.330 | V |
| Output Voltage (Accuracy) $V_{in} = 3.7\text{ V}$ to 7.3 V , $I_{load} = 0.1\text{ mA}$ to 500 mA , $T_A = 0^\circ\text{C}$ to $+85^\circ\text{C}$ | V_{out} | -1.40% 3.254 | 3.3 | 1.40% 3.346 | V |
| Output Voltage (Accuracy) $V_{in} = 3.7\text{ V}$ to 7.3 V , $I_{load} = 0.1\text{ mA}$ to 500 mA , $T_A = -40^\circ\text{C}$ to $+125^\circ\text{C}$ | V_{out} | -1.50% 3.250 | 3.3 | 1.50% 3.350 | V |
| Line Regulation $V_{in} = 3.7\text{ V}$ to 12 V , $I_{load} = 0.1\text{ mA}$ | LineReg | | 0.04 | | mV/V |
| Load Regulation $V_{in} = 3.7\text{ V}$, $I_{load} = 0.1\text{ mA}$ to 500 mA | LoadReg | | 0.04 | | mV/mA |
| Dropout Voltage (See Application Note) $I_{load} = 500\text{ mA}$ $I_{load} = 300\text{ mA}$ $I_{load} = 50\text{ mA}$ $I_{load} = 0.1\text{ mA}$ | V_{DO} | | 340 230 110 10 | | mV |
| Peak Output Current (See Figure 14) | I_{pk} | 500 | 700 | 800 | mA |
| Short Output Current (See Figure 14) $V_{in} < 7\text{ V}$, $T_A = 25^\circ\text{C}$ | I_{sc} | | | 900 | mA |
| Thermal Shutdown / Hysteresis | T_J | | 160/10 | | $^\circ\text{C}$ |
| Ground Current In Regulation $I_{load} = 500\text{ mA}$ (Note 7) $I_{load} = 300\text{ mA}$ $I_{load} = 50\text{ mA}$ $I_{load} = 0.1\text{ mA}$ In Dropout $V_{in} = 3.7\text{ V}$, $I_{load} = 0.1\text{ mA}$ In Shutdown $V_{SD} = 0\text{ V}$ | I_{GND} I_{GNDsh} | | 9 4.6 0.8 - | 14 7.5 2.5 220 500 1 | mA μA μA μA |
| Output Noise $C_{nr} = 0\text{ nF}$, $I_{load} = 500\text{ mA}$, $f = 10\text{ Hz}$ to 100 kHz , $C_{out} = 10\text{ }\mu\text{F}$ $C_{nr} = 10\text{ nF}$, $I_{load} = 500\text{ mA}$, $f = 10\text{ Hz}$ to 100 kHz , $C_{out} = 10\text{ }\mu\text{F}$ | V_{noise} | | 69 46 | | μVrms |
| Power Good Voltage Low Threshold Hysteresis High Threshold | V_{elft} | 93 | 95 2 97 | 99 | % of V_{out} |
| Power Good Pin Voltage Saturation ($I_{ef} = 1.0\text{ mA}$) | V_{efdo} | | 200 | | mV |
| Power Good Pin Leakage | I_{efleak} | | 1 | | μA |
| Power Good Blanking Time (Note 6) | t_{ef} | | 50 | | μs |
| Shutdown Threshold Voltage ON Threshold Voltage OFF | V_{SD} | 2 | | 0.4 | V |
| SD Input Current, $V_{SD} = 0\text{ V}$ to 0.4 V or $V_{SD} = 2.0\text{ V}$ to V_{in} | I_{SD} | | 0.07 | 1 | μA |
| Output Current In Shutdown Mode, $V_{out} = 0\text{ V}$ | I_{OSD} | | 0.07 | 1 | μA |
| Reverse Bias Protection, Current Flowing from the Output Pin to GND ($V_{in} = 0\text{ V}$, $V_{out_forced} = 3.3\text{ V}$) | I_{OUTR} | | 10 | | μA |

5. Performance guaranteed over the operating temperature range by design and/or characterization, production tested at $T_J = T_A = 25^\circ\text{C}$. Low duty cycle pulse techniques are used during testing to maintain the junction temperature as close to ambient as possible.
6. Can be disabled per customer request.
7. T_A must be greater than 0°C .

NCP3337

ELECTRICAL CHARACTERISTICS – 2.5 V ($V_{out} = 2.5$ V typical, $V_{in} = 2.9$ V, $T_A = -40^{\circ}\text{C}$ to $+85^{\circ}\text{C}$, unless otherwise noted, Note 8)

| Characteristic | Symbol | Min | Typ | Max | Unit |
|--|--|----------------|-------------------------|-------------------------|---|
| Output Voltage (Accuracy) $V_{in} = 2.9$ V to 6.5 V, $I_{load} = 0.1$ mA to 500 mA, $T_A = 25^{\circ}\text{C}$ | V_{out} | -0.9% 2.477 | 2.5 | +0.9% 2.523 | V |
| Output Voltage (Accuracy) $V_{in} = 2.9$ V to 6.5 V, $I_{load} = 0.1$ mA to 500 mA, $T_A = 0^{\circ}\text{C}$ to $+85^{\circ}\text{C}$ | V_{out} | -1.4% 2.465 | 2.5 | +1.4% 2.535 | V |
| Output Voltage (Accuracy) $V_{in} = 2.9$ V to 6.5 V, $I_{load} = 0.1$ mA to 500 mA, $T_A = -40^{\circ}\text{C}$ to $+125^{\circ}\text{C}$ | V_{out} | -1.5% 2.462 | 2.5 | +1.5% 2.538 | V |
| Minimum Input Voltage | V_{inmin} | | 2.9 | | V |
| Line Regulation $V_{in} = 2.9$ V to 12 V, $I_{load} = 0.1$ mA | LineReg | | 0.04 | | mV/V |
| Load Regulation $V_{in} = 2.9$ V, $I_{load} = 0.1$ mA to 500 mA | LoadReg | | 0.04 | | mV/mA |
| Dropout Voltage (See Figure 10) $I_{load} = 500$ mA (Note 9) $I_{load} = 300$ mA (Note 9) $I_{load} = 50$ mA $I_{load} = 0.1$ mA | V_{DO} | | 340 230 110 10 | | mV |
| Peak Output Current (See Figures 14 and 18) | I_{pk} | 500 | 700 | 800 | mA |
| Short Output Current (See Figure 14) $V_{in} < 7$ V, $T_A = 25^{\circ}\text{C}$ | I_{sc} | | | 900 | mA |
| Thermal Shutdown / Hysteresis | T_J | | 160/10 | | $^{\circ}\text{C}$ |
| Ground Current In Regulation $I_{load} = 500$ mA (Note 9) $I_{load} = 300$ mA (Note 9) $I_{load} = 50$ mA $I_{load} = 0.1$ mA In Dropout $V_{in} = 2.4$ V, $I_{load} = 0.1$ mA In Shutdown $V_{SD} = 0$ V | I_{GND} I_{GNDsh} | | 9.0 4.6 0.8 – | 14 7.5 2.5 220 | mA μA |
| Output Noise $C_{nr} = 0$ nF, $I_{load} = 500$ mA, $f = 10$ Hz to 100 kHz, $C_{out} = 10$ μF $C_{nr} = 10$ nF, $I_{load} = 500$ mA, $f = 10$ Hz to 100 kHz, $C_{out} = 10$ μF | V_{noise} | | 56 35 | | μVrms μVrms |
| Power Good Voltage Low Threshold Hysteresis High Threshold | V_{elft} | 93 | 95 2 97 | 99 | % of V_{out} |
| Power Good Pin Voltage Saturation ($I_{ef} = 1.0$ mA) | V_{efdo} | | 200 | | mV |
| Power Good Pin Leakage | I_{efleak} | | 1.0 | | μA |
| Power Good Blanking Time (Note 10) | t_{ef} | | 50 | | μs |
| Shutdown Threshold Voltage ON Threshold Voltage OFF | V_{SD} | 2.0 | | 0.4 | V V |
| S_D Input Current, $V_{SD} = 0$ V to 0.4 V or $V_{SD} = 2.0$ V to V_{in} | I_{SD} | | 0.07 | 1.0 | μA |
| Output Current In Shutdown Mode, $V_{out} = 0$ V | I_{OSD} | | 0.07 | 1.0 | μA |
| Reverse Bias Protection, Current Flowing from the Output Pin to GND ($V_{in} = 0$ V, $V_{out_forced} = 2.5$ V) | I_{OUTR} | | 10 | | μA |

8. Performance guaranteed over the operating temperature range by design and/or characterization, production tested at $T_J = T_A = 25^{\circ}\text{C}$. Low duty cycle pulse techniques are used during testing to maintain the junction temperature as close to ambient as possible.

9. T_A must be greater than 0°C .

10. Can be disabled per customer request.

NCP3337

ELECTRICAL CHARACTERISTICS – 1.8 V ($V_{out} = 1.8$ V typical, $V_{in} = 2.9$ V, $T_A = -40^{\circ}\text{C}$ to $+85^{\circ}\text{C}$, unless otherwise noted, Note 11)

| Characteristic | Symbol | Min | Typ | Max | Unit |
|--|--|----------------|------------------------|-------------------------|---|
| Output Voltage (Accuracy) $V_{in} = 2.9$ V to 5.8 V, $I_{load} = 0.1$ mA to 500 mA, $T_A = 25^{\circ}\text{C}$ | V_{out} | -0.9% 1.783 | 1.8 | +0.9% 1.817 | V |
| Output Voltage (Accuracy) $V_{in} = 2.9$ V to 5.8 V, $I_{load} = 0.1$ mA to 500 mA, $T_A = 0^{\circ}\text{C}$ to $+85^{\circ}\text{C}$ | V_{out} | -1.4% 1.774 | 1.8 | +1.4% 1.826 | V |
| Output Voltage (Accuracy) $V_{in} = 2.9$ V to 5.8 V, $I_{load} = 0.1$ mA to 500 mA, $T_A = -40^{\circ}\text{C}$ to $+125^{\circ}\text{C}$ | V_{out} | -1.5% 1.773 | 1.8 | +1.5% 1.827 | V |
| Minimum Input Voltage | V_{inmin} | | 2.9 | | V |
| Line Regulation $V_{in} = 2.9$ V to 12 V, $I_{load} = 0.1$ mA | LineReg | | 0.04 | | mV/V |
| Load Regulation $V_{in} = 2.9$ V, $I_{load} = 0.1$ mA to 500 mA | LoadReg | | 0.04 | | mV/mA |
| Dropout Voltage (See Figure 9) $I_{load} = 500$ mA (Notes 12, 13) $I_{load} = 300$ mA (Notes 12, 13) $I_{load} = 50$ mA (Notes 12, 13) | V_{DO} | | 620 230 95 | | mV |
| Peak Output Current (See Figures 14 and 17) | I_{pk} | 500 | 700 | 830 | mA |
| Short Output Current (See Figure 14) $V_{in} < 7$ V, $T_A = 25^{\circ}\text{C}$ | I_{sc} | | | 900 | mA |
| Thermal Shutdown / Hysteresis | T_J | | 160/10 | | $^{\circ}\text{C}$ |
| Ground Current In Regulation $I_{load} = 500$ mA (Note 12) $I_{load} = 300$ mA (Note 12) $I_{load} = 50$ mA $I_{load} = 0.1$ mA In Dropout $V_{in} = 2.2$ V, $I_{load} = 0.1$ mA In Shutdown $V_{SD} = 0$ V | I_{GND} I_{GNDsh} | | 9.0 4.6 0.8 – | 14 7.5 2.5 220 | mA μA |
| Output Noise $C_{nr} = 0$ nF, $I_{load} = 500$ mA, $f = 10$ Hz to 100 kHz, $C_{out} = 10$ μF $C_{nr} = 10$ nF, $I_{load} = 500$ mA, $f = 10$ Hz to 100 kHz, $C_{out} = 10$ μF | V_{noise} | | 52 33 | | μVrms μVrms |
| Power Good Voltage Low Threshold Hysteresis High Threshold | V_{elft} | 93 | 95 2 97 | 99 | % of V_{out} |
| Power Good Pin Voltage Saturation ($I_{ef} = 1.0$ mA) | V_{efdo} | | 200 | | mV |
| Power Good Pin Leakage | I_{efleak} | | 1.0 | | μA |
| Power Good Blanking Time (Note 10) | t_{ef} | | 50 | | μs |
| Shutdown Threshold Voltage ON Threshold Voltage OFF | V_{SD} | 2.0 | | 0.4 | V V |
| SD Input Current, $V_{SD} = 0$ V to 0.4 V or $V_{SD} = 2.0$ V to V_{in} | I_{SD} | | 0.07 | 1.0 | μA |
| Output Current In Shutdown Mode, $V_{out} = 0$ V | I_{OSD} | | 0.07 | 1.0 | μA |
| Reverse Bias Protection, Current Flowing from the Output Pin to GND ($V_{in} = 0$ V, $V_{out_forced} = 1.8$ V) | I_{OUTR} | | 10 | | μA |

11. Performance guaranteed over the operating temperature range by design and/or characterization, production tested at $T_J = T_A = 25^{\circ}\text{C}$. Low duty cycle pulse techniques are used during testing to maintain the junction temperature as close to ambient as possible.

12. T_A must be greater than 0°C .

13. Maximum dropout voltage is limited by minimum input voltage $V_{in} = 2.9$ V recommended for guaranteed operation.

NCP3337

ELECTRICAL CHARACTERISTICS – ADJUSTABLE ($V_{out} = 1.25$ V typical, $V_{in} = 2.9$ V, $T_A = -40^{\circ}\text{C}$ to $+85^{\circ}\text{C}$, unless otherwise noted, Note 14)

| Characteristic | Symbol | Min | Typ | Max | Unit |
|---|--|-----------------|-------------------------|---|--|
| Reference Voltage (Accuracy) $V_{in} = 2.9$ V to $V_{out} + 4.0$ V, $I_{load} = 0.1$ mA to 500 mA, $T_A = 25^{\circ}\text{C}$ | V_{ref} | -0.90% 1.239 | 1.25 | 0.90% 1.261 | V |
| Reference Voltage (Accuracy) $V_{in} = 2.9$ V to $V_{out} + 4.0$ V, $I_{load} = 0.1$ mA to 500 mA, $T_A = 0^{\circ}\text{C}$ to $+85^{\circ}\text{C}$ | V_{ref} | -1.40% 1.233 | 1.25 | 1.40% 1.268 | V |
| Reference Voltage (Accuracy) (Note 18) $V_{in} = 2.9$ V to $V_{out} + 4.0$ V, $I_{load} = 0.1$ mA to 500 mA, $T_A = -40^{\circ}\text{C}$ to $+125^{\circ}\text{C}$ | V_{ref} | -1.50% 1.231 | 1.25 | 1.50% 1.269 | V |
| Line Regulation $V_{in} = 2.9$ V to 12 V, $I_{load} = 0.1$ mA | $Line_{Reg}$ | | 0.04 | | mV/V |
| Load Regulation $V_{in} = 2.9$ V to 12 V, $I_{load} = 0.1$ mA to 500 mA | $Load_{Reg}$ | | 0.04 | | mV/mA |
| Dropout Voltage (See Application Note) ($V_{out} = 2.5$ V – 10 V) $I_{load} = 500$ mA (Note 16) $I_{load} = 300$ mA $I_{load} = 50$ mA $I_{load} = 0.1$ mA | V_{DO} | | 340 230 110 10 | | mV |
| Peak Output Current (See Figure 14) | I_{pk} | 500 | 700 | 830 | mA |
| Short Output Current (See Figure 14) $V_{in} < 7$ V, $T_A = 25^{\circ}\text{C}$ $V_{out} \leq 3.3$ V $V_{out} > 3.3$ V | I_{sc} | | | 900 930 | mA |
| Thermal Shutdown / Hysteresis | T_J | | 160/ 10 | | $^{\circ}\text{C}$ |
| Ground Current In Regulation $I_{load} = 500$ mA (Note 16) $I_{load} = 300$ mA (Note 16) $I_{load} = 50$ mA $I_{load} = 0.1$ mA In Dropout $V_{in} = V_{out} + 0.1$ V or 2.9 V (whichever is higher), $I_{load} = 0.1$ mA In Shutdown $V_{SD} = 0$ V | I_{GND} I_{GNDsh} | | 9 4.6 0.8 | 14 7.5 2.5 220 500 1 | mA μA μA |
| Output Noise $C_{nr} = 0$ nF, $I_{load} = 500$ mA, $f = 10$ Hz to 100 kHz, $C_{out} = 10$ μF $C_{nr} = 10$ nF, $I_{load} = 500$ mA, $f = 10$ Hz to 100 kHz, $C_{out} = 10$ μF | V_{noise} | | 69 46 | | μV_{rms} |
| Power Good Voltage Low Threshold Hysteresis High Threshold | V_{elft} | 93 | 95 2 97 | 99 | % of V_{out} |
| Power Good Pin Voltage Saturation ($I_{ef} = 1.0$ mA) | V_{efdo} | | 200 | | mV |
| Power Good Pin Leakage | I_{efleak} | | 1 | | μA |
| Power Good Pin Blanking Time (Note 15) | t_{ef} | | 50 | | μs |
| Shutdown Threshold Voltage ON Threshold Voltage OFF | V_{SD} | 2 | | 0.4 | V |
| SD Input Current, $V_{SD} = 0$ V to 0.4 V or $V_{SD} = 2.0$ V to V_{in} $V_{in} \leq 5.4$ V $V_{in} > 5.4$ V | I_{SD} | | 0.07 | 1 5 | μA |
| Output Current In Shutdown Mode, $V_{out} = 0$ V | I_{OSD} | | 0.07 | 1 | μA |
| Reverse Bias Protection, Current Flowing from the Output Pin to GND ($V_{in} = 0$ V, $V_{out_forced} = V_{out(nom)} \leq 7$ V) (Note 17) | I_{OUTR} | | 1 | | μA |

14. Performance guaranteed over the operating temperature range by design and/or characterization, production tested at $T_J = T_A = 25^{\circ}\text{C}$. Low duty cycle pulse techniques are used during testing to maintain the junction temperature as close to ambient as possible.

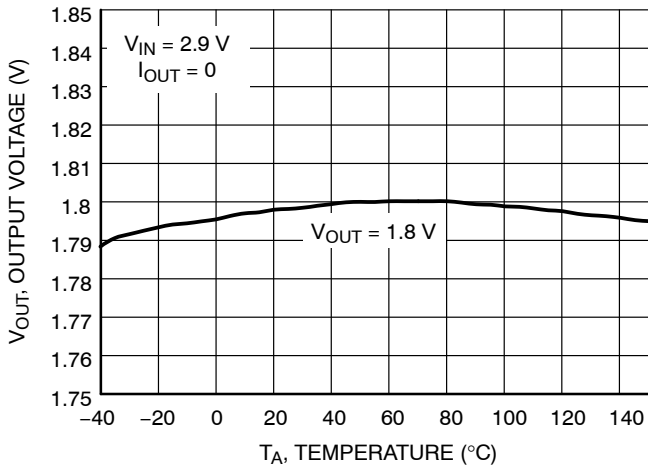
15. Can be disabled per customer request.

16. T_A must be greater than 0°C .

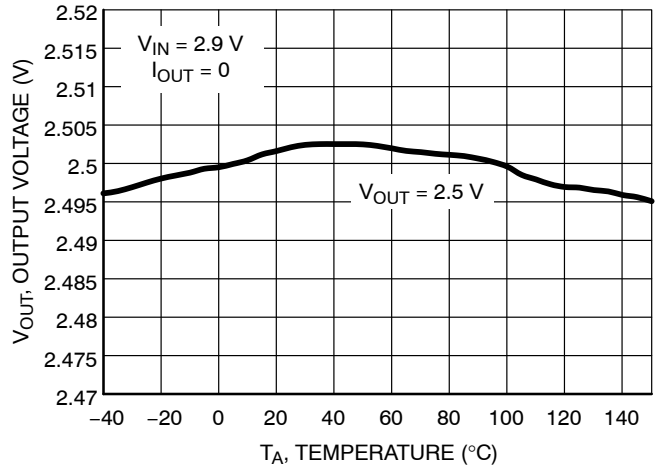
17. Reverse bias protection feature valid only if $V_{out} - V_{in} \leq 7$ V.

18. For output current capability for $T_A < 0^{\circ}\text{C}$, please refer to Figures 17 and 18.

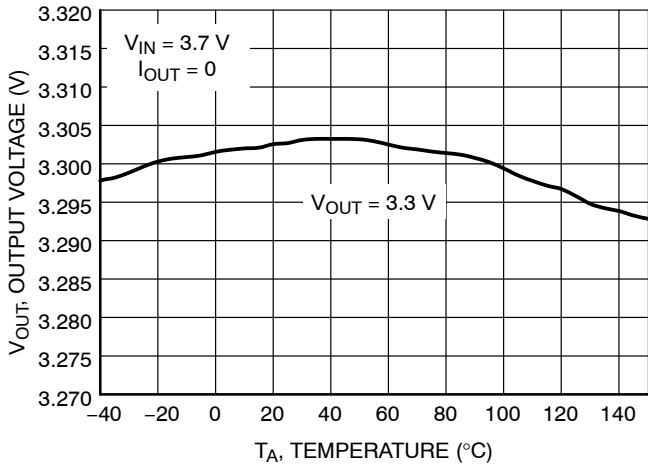
NCP3337



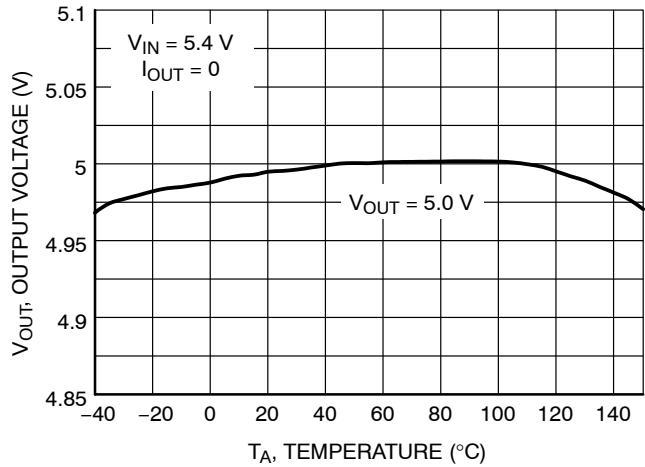
**Figure 5. Output Voltage vs. Temperature
1.8 V Version**



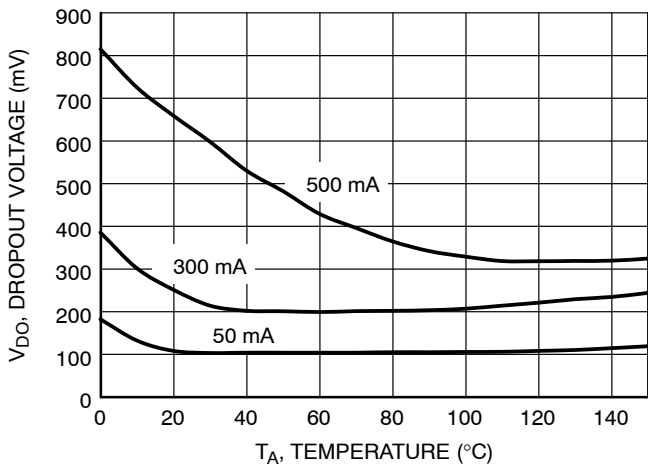
**Figure 6. Output Voltage vs. Temperature
2.5 V Version**



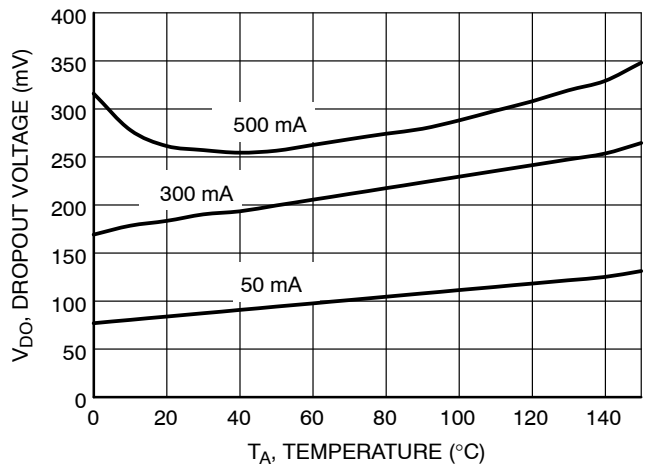
**Figure 7. Output Voltage vs. Temperature
3.3 V Version**



**Figure 8. Output Voltage vs. Temperature
5.0 V Version**

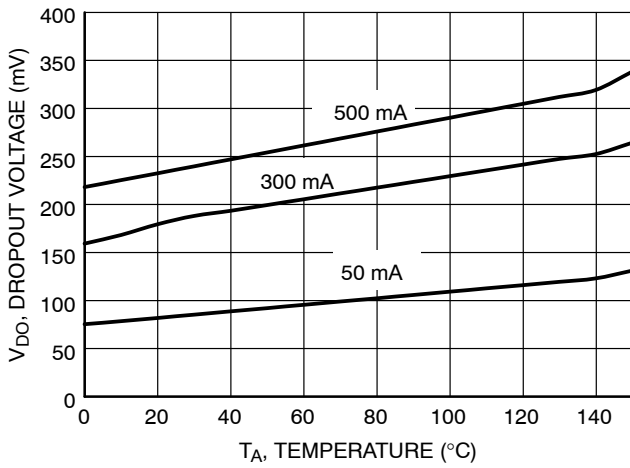


**Figure 9. Dropout Voltage vs. Temperature
1.8 V Version**

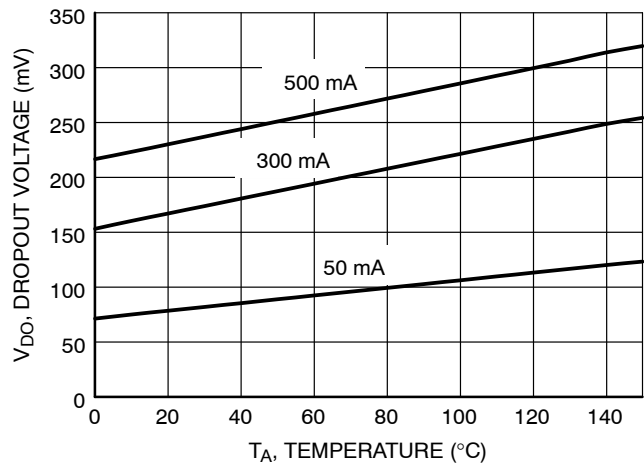


**Figure 10. Dropout Voltage vs. Temperature
2.5 V Version**

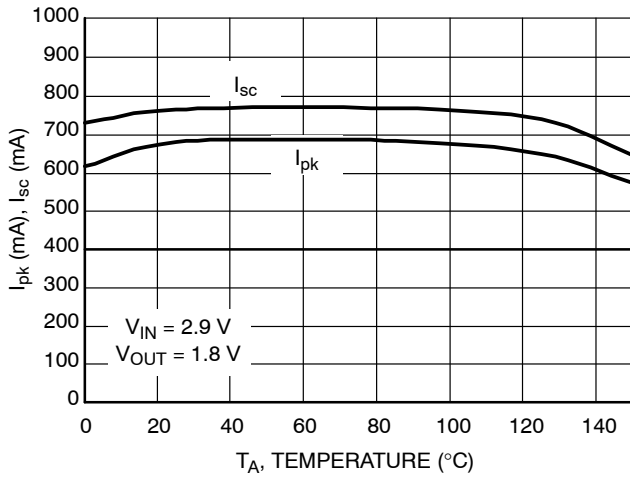
NCP3337



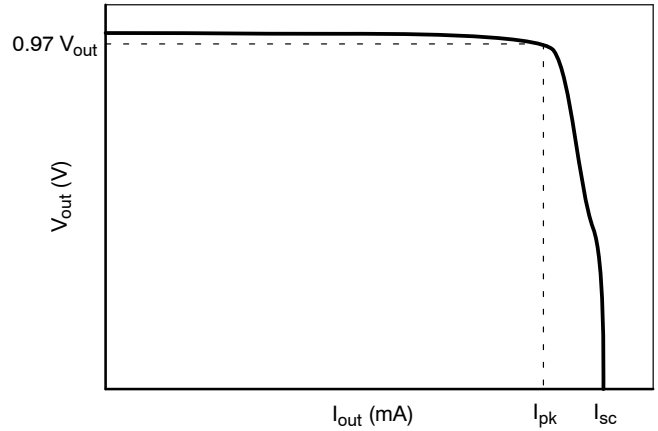
**Figure 11. Dropout Voltage vs. Temperature
3.3 V Version**



**Figure 12. Dropout Voltage vs. Temperature
5.0 V Version**



**Figure 13. Peak and Short Current
vs. Temperature**



(For specific values of I_{pk} and I_{sc} , please refer to Figure 13)

Figure 14. Output Voltage vs. Output Current

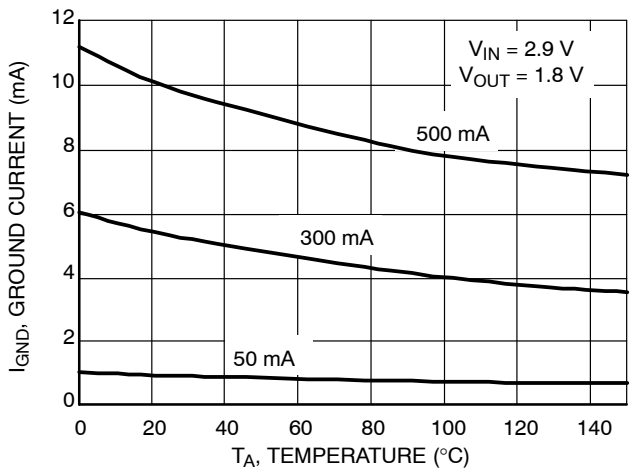


Figure 15. Ground Current vs. Temperature

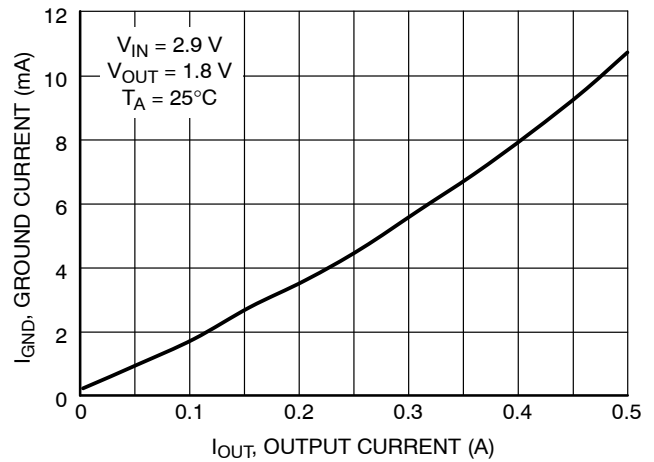


Figure 16. Ground Current vs. Output Current

NCP3337

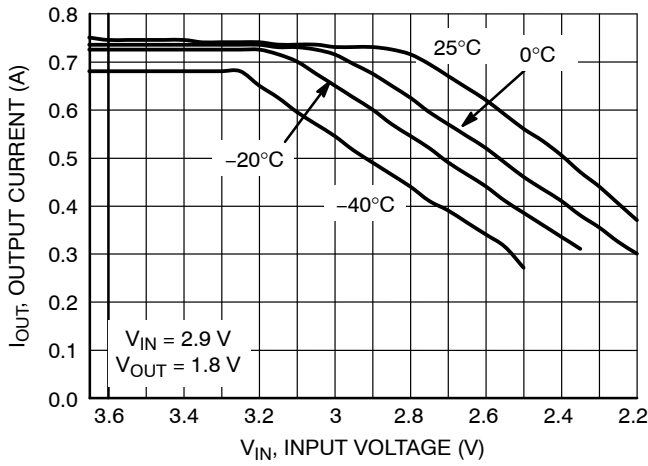


Figure 17. Output Current Capability for the 1.8 V Version

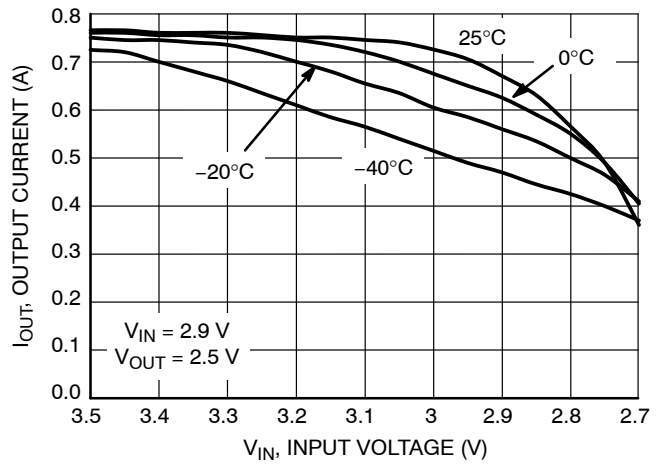


Figure 18. Output Current Capability for the 2.5 V Version

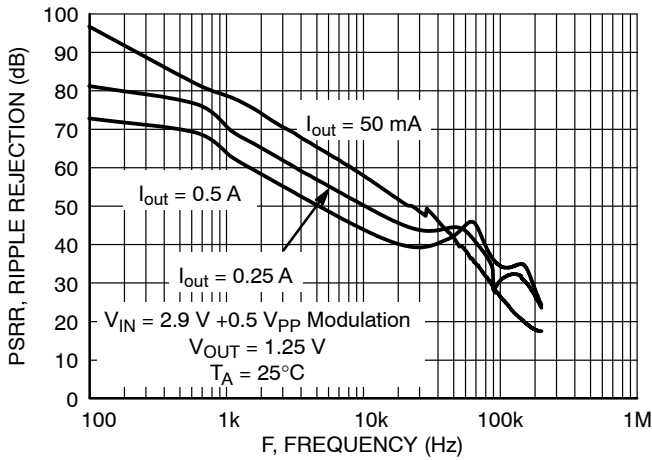


Figure 20. PSRR vs. Frequency Adjustable Version

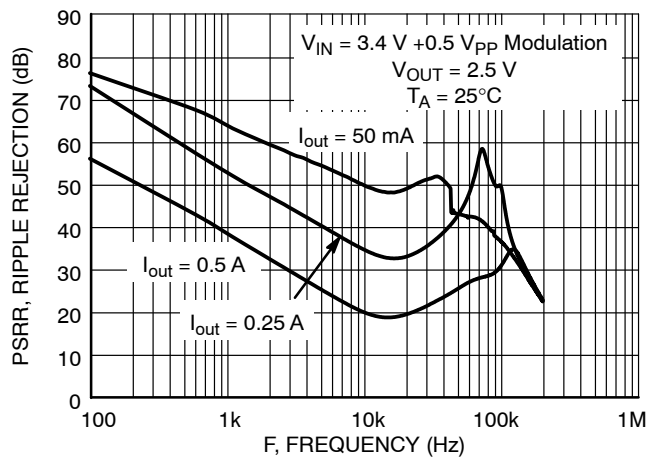


Figure 21. PSRR vs. Frequency 2.5 V Version

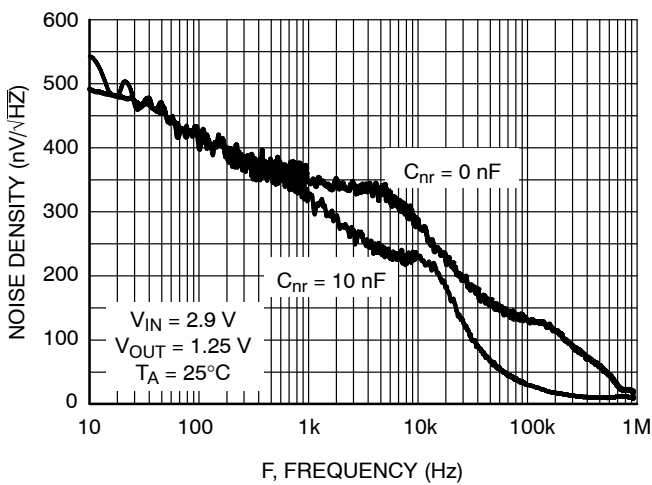


Figure 22. Output Noise Density Adjustable Version

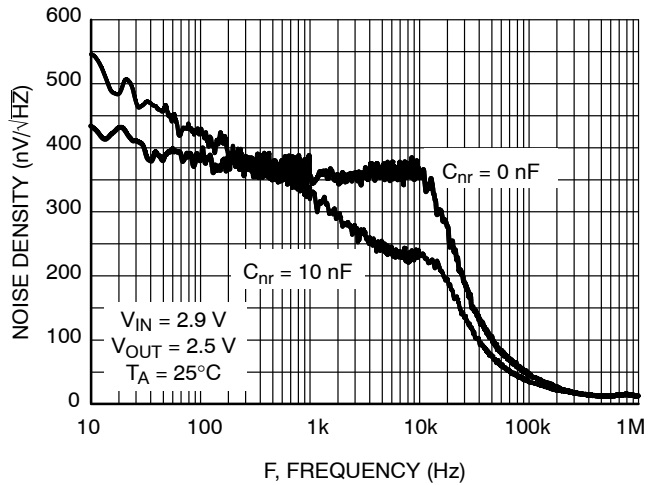


Figure 23. Output Noise Density 2.5 V Version

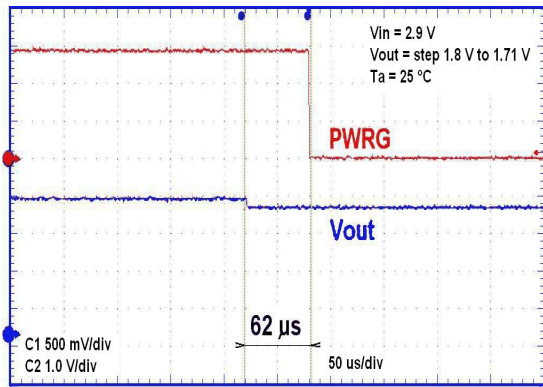


Figure 24. Power Good Activation

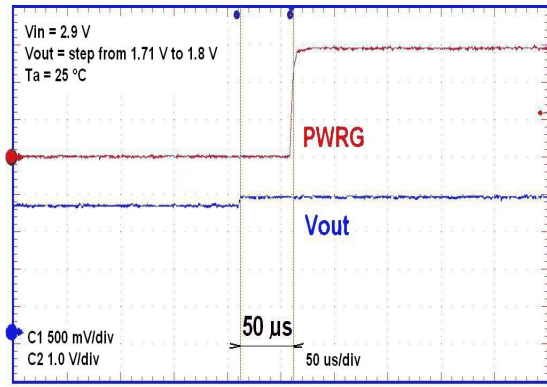


Figure 25. Power Good Inactivation

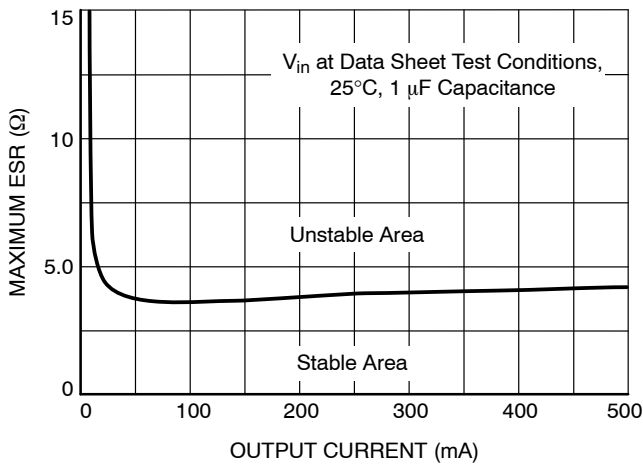


Figure 26. Stability with ESR vs. Output Current

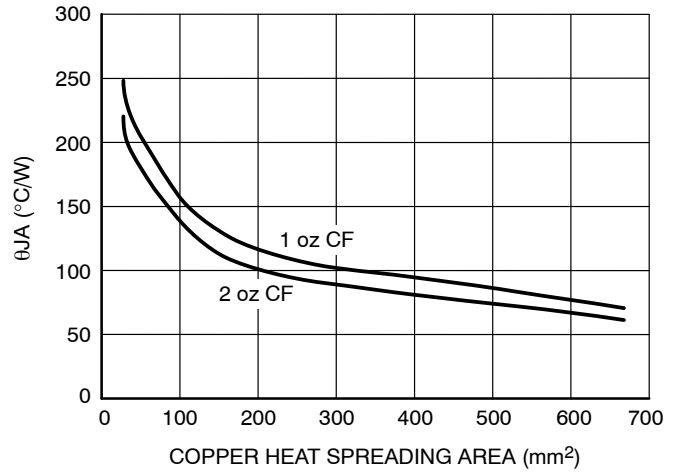


Figure 27. DFN10 Self-Heating Thermal Characteristics as a Function of Copper Area on the PCB

NOTE: Typical characteristics were measured with the same conditions as electrical characteristics.

APPLICATIONS INFORMATION

Reverse Bias Protection

Reverse bias is a condition caused when the input voltage goes to zero, but the output voltage is kept high either by a large output capacitor or another source in the application which feeds the output pin.

Normally in a bipolar LDO all the current will flow from the output pin to input pin through the PN junction with limited current capability and with the potential to destroy the IC.

Due to an improved architecture, the NCP3337 can withstand up to 7.0 V on the output pin with virtually no current flowing from output pin to input pin, and only negligible amount of current (tens of μA) flowing from the output pin to ground for infinite duration.

Input Capacitor

An input capacitor of at least 1.0 μF , any type, is recommended to improve the transient response of the regulator and/or if the regulator is located more than a few inches from the power source. It will also reduce the circuit's sensitivity to the input line impedance at high frequencies. The capacitor should be mounted with the shortest possible track length directly across the regulator's input terminals.

Output Capacitor

The NCP3337 remains stable with any type of capacitor as long as it fulfills its 1.0 μF requirement. There are no constraints on the minimum ESR and it will remain stable up to an ESR of 5.0 Ω . Larger capacitor values will improve the noise rejection and load transient response.

Noise Reduction Pin

Output noise can be greatly reduced by connecting a 10 nF capacitor (C_{nr}) between the noise reduction pin and ground (see Figure 1). In applications where very low noise is not required, the noise reduction pin can be left unconnected.

Dropout Voltage

The voltage dropout is measured at 97% of the nominal output voltage.

Thermal Considerations

Internal thermal limiting circuitry is provided to protect the integrated circuit in the event that the maximum junction

temperature is exceeded. This feature provides protection from a catastrophic device failure due to accidental overheating. This protection feature is not intended to be used as a substitute to heat sinking. The maximum power that can be dissipated, can be calculated with the equation below:

$$P_D = \frac{T_{J(\max)} - T_A}{R_{\theta JA}} \quad (\text{eq. 1})$$

For improved thermal performance, contact the factory for the DFN package option. The DFN package includes an exposed metal pad that is specifically designed to reduce the junction to air thermal resistance, $R_{\theta JA}$.

Adjustable Operation

The output voltage can be set by using a resistor divider as shown in Figure 2 with a range of 1.25 to 10 V. The appropriate resistor divider can be found by solving the equation below. The recommended current through the resistor divider is from 10 μA to 100 μA . This can be accomplished by selecting resistors in the $\text{k}\Omega$ range. As result, the $I_{\text{adj}} * R_2$ becomes negligible in the equation and can be ignored.

$$V_{\text{out}} = 1.25 * (1 + R_3/R_2) + I_{\text{adj}} * R_2 \quad (\text{eq. 2})$$

Power Good Operation

The Power Good pin on the NCP3337 will produce a logic Low when it drops below the nominal output voltage. Refer to the electrical characteristics for the threshold values at which point the Power Good goes Low. When the NCP3337 is above the nominal output voltage, the Power Good will remain at logic High.

The external pullup resistor needs to be connected between V_{in} and the Power Good pin. A resistor of approximately 100 $\text{k}\Omega$ is recommended to minimize the current consumption. No pullup resistor is required if the Power Good output is not being used. The Power Good does not function during thermal shutdown and when the part is disabled.

NCP3337

ORDERING INFORMATION

| Device | Nominal Output Voltage | Marking | Package | Shipping† |
|-----------------|------------------------|-----------|--------------------|--------------------|
| NCP3337MN180R2G | 1.8 V | P3337 180 | DFN10 (Pb-Free) | 3000 / Tape & Reel |
| NCP3337MN250R2G | 2.5 V | P3337 250 | DFN10 (Pb-Free) | 3000 / Tape & Reel |
| NCP3337MN330R2G | 3.3 V | P3337 330 | DFN10 (Pb-Free) | 3000 / Tape & Reel |
| NCP3337MN500R2G | 5.0 V | P3337 500 | DFN10 (Pb-Free) | 3000 / Tape & Reel |
| NCP3337MNADJR2G | Adj | P3337 ADJ | DFN10 (Pb-Free) | 3000 / Tape & Reel |

†For information on tape and reel specifications, including part orientation and tape sizes, please refer to our Tape and Reel Packaging Specifications Brochure, BRD8011/D.

*Please contact factory for other voltage options.

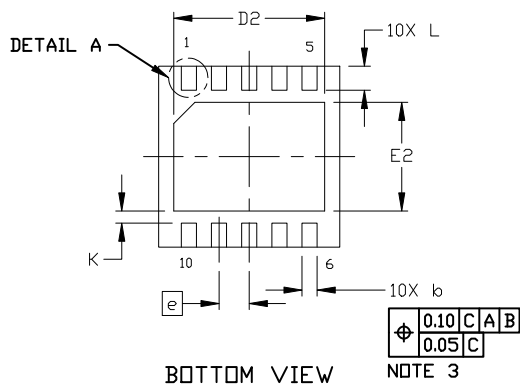
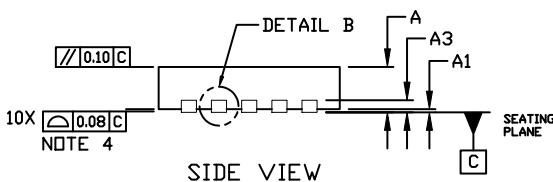
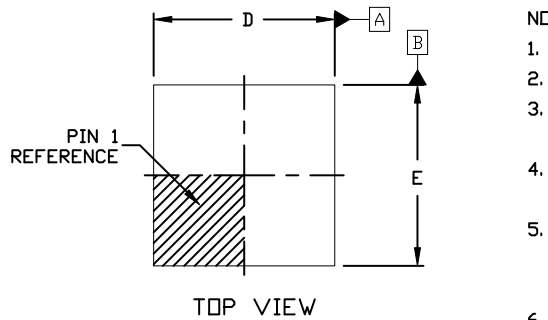
MECHANICAL CASE OUTLINE PACKAGE DIMENSIONS



SCALE 2:1

DFN10, 3x3, 0.5P CASE 485C ISSUE F

DATE 16 DEC 2021



GENERIC MARKING DIAGRAM*

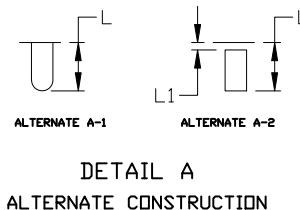
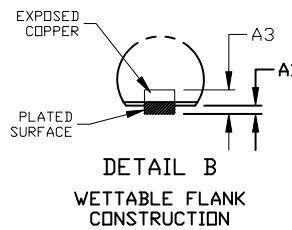
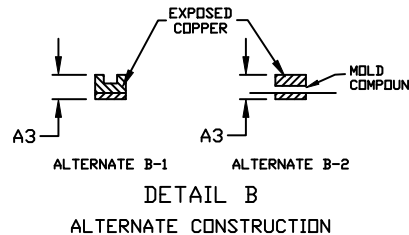


- XXXXX = Specific Device Code
- A = Assembly Location
- L = Wafer Lot
- Y = Year
- W = Work Week
- = Pb-Free Package

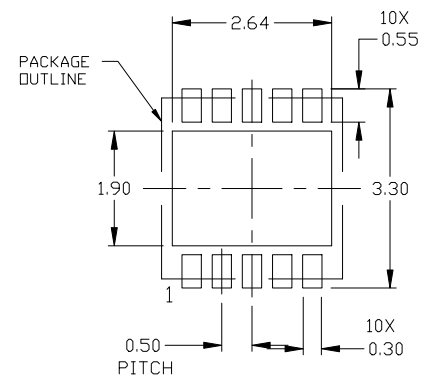
(Note: Microdot may be in either location)

NOTES:

1. DIMENSION AND TOLERANCING PER ASME Y14.5, 2009.
2. CONTROLLING DIMENSION: MILLIMETERS
3. DIMENSION *b* APPLIES TO PLATED TERMINAL AND IS MEASURED BETWEEN 0.15 AND 0.30 MM FROM THE TERMINAL TIP.
4. COPLANARITY APPLIES TO THE EXPOSED PAD AS WELL AS THE TERMINALS.
5. TERMINAL *b* MAY HAVE MOLD COMPOUND MATERIAL ALONG SIDE EDGE. MOLD FLASH MAY NOT EXCEED 30 MICRONS ONTO BOTTOM SURFACE OF TERMINAL.
6. FOR DEVICE OPN CONTAINING W OPTION, DETAIL A AND DETAIL B ALTERNATE CONSTRUCTIONS ARE NOT APPLICABLE. WETTABLE FLANK CONSTRUCTION IS DETAIL B AS SHOWN ON SIDE VIEW OF PACKAGE.



| DIM | MILLIMETERS | | |
|----------|-------------|------|------|
| | MIN. | NOM. | MAX. |
| A | 0.80 | 0.90 | 1.00 |
| A1 | 0.00 | --- | 0.05 |
| A3 | 0.20 REF | | |
| <i>b</i> | 0.18 | 0.23 | 0.30 |
| D | 2.90 | 3.00 | 3.10 |
| D2 | 2.40 | 2.50 | 2.60 |
| E | 2.90 | 3.00 | 3.10 |
| E2 | 1.70 | 1.80 | 1.90 |
| <i>e</i> | 0.50 BSC | | |
| K | 0.20 REF | | |
| L | 0.30 | 0.40 | 0.50 |
| L1 | --- | --- | 0.03 |



RECOMMENDED MOUNTING FOOTPRINT

For additional information on our Pb-Free strategy and soldering details, please download the ON Semiconductor Soldering and Mounting Techniques Reference Manual, SOLDERRM/D.

*This information is generic. Please refer to device data sheet for actual part marking. Pb-Free indicator, "G" or microdot "▪", may or may not be present. Some products may not follow the Generic Marking.

| | | |
|------------------|-----------------------------|--|
| DOCUMENT NUMBER: | 98AON03161D | Electronic versions are uncontrolled except when accessed directly from the Document Repository. Printed versions are uncontrolled except when stamped "CONTROLLED COPY" in red. |
| DESCRIPTION: | DFN10, 3X3 MM, 0.5 MM PITCH | PAGE 1 OF 1 |

onsemi and ONSEMI are trademarks of Semiconductor Components Industries, LLC dba onsemi or its subsidiaries in the United States and/or other countries. onsemi reserves the right to make changes without further notice to any products herein. onsemi makes no warranty, representation or guarantee regarding the suitability of its products for any particular purpose, nor does onsemi assume any liability arising out of the application or use of any product or circuit, and specifically disclaims any and all liability, including without limitation special, consequential or incidental damages. onsemi does not convey any license under its patent rights nor the rights of others.

onsemi, **Onsemi**, and other names, marks, and brands are registered and/or common law trademarks of Semiconductor Components Industries, LLC dba "**onsemi**" or its affiliates and/or subsidiaries in the United States and/or other countries. **onsemi** owns the rights to a number of patents, trademarks, copyrights, trade secrets, and other intellectual property. A listing of **onsemi**'s product/patent coverage may be accessed at www.onsemi.com/site/pdf/Patent-Marking.pdf. **onsemi** reserves the right to make changes at any time to any products or information herein, without notice. The information herein is provided "as-is" and **onsemi** makes no warranty, representation or guarantee regarding the accuracy of the information, product features, availability, functionality, or suitability of its products for any particular purpose, nor does **onsemi** assume any liability arising out of the application or use of any product or circuit, and specifically disclaims any and all liability, including without limitation special, consequential or incidental damages. Buyer is responsible for its products and applications using **onsemi** products, including compliance with all laws, regulations and safety requirements or standards, regardless of any support or applications information provided by **onsemi**. "Typical" parameters which may be provided in **onsemi** data sheets and/or specifications can and do vary in different applications and actual performance may vary over time. All operating parameters, including "Typicals" must be validated for each customer application by customer's technical experts. **onsemi** does not convey any license under any of its intellectual property rights nor the rights of others. **onsemi** products are not designed, intended, or authorized for use as a critical component in life support systems or any FDA Class 3 medical devices or medical devices with a same or similar classification in a foreign jurisdiction or any devices intended for implantation in the human body. Should Buyer purchase or use **onsemi** products for any such unintended or unauthorized application, Buyer shall indemnify and hold **onsemi** and its officers, employees, subsidiaries, affiliates, and distributors harmless against all claims, costs, damages, and expenses, and reasonable attorney fees arising out of, directly or indirectly, any claim of personal injury or death associated with such unintended or unauthorized use, even if such claim alleges that **onsemi** was negligent regarding the design or manufacture of the part. **onsemi** is an Equal Opportunity/Affirmative Action Employer. This literature is subject to all applicable copyright laws and is not for resale in any manner.

PUBLICATION ORDERING INFORMATION

LITERATURE FULFILLMENT:

Email Requests to: orderlit@onsemi.com

onsemi Website: www.onsemi.com

TECHNICAL SUPPORT

North American Technical Support:

Voice Mail: 1 800-282-9855 Toll Free USA/Canada

Phone: 011 421 33 790 2910

Europe, Middle East and Africa Technical Support:

Phone: 00421 33 790 2910

For additional information, please contact your local Sales Representative