



规格书
SPECIFICATIONS

规格书编号/ID: M13521271510A
物料描述/
Product Description: 13.52127M 15PF 10PPM
料号/
Part Number: S47SMD13.52127M15PF10R30B3
制作人/
Approved by: 莫平会
审核人/
Checked by: 陈晓群
日期/ 盖章/
Date: 2022-12-30 Stamp: _____

客户签署/
Customer signature required

公司名称/
Company: _____

客户料号/
Customer Part Number: _____

承认人/
Approved by: _____

批准人/
Confirmed by: _____

日期/
Date: _____

盖章/
Stamp: _____



四川索斯特电子有限公司
Sichuan Source-Set Electronics Co., Ltd
石英晶体规格书



CRYSTAL UNIT SPECIFICATIONS

一、电性能参数 ELECTRICAL PARAMETERS:

No.	特性 Characteristic	范围 Limits	备注 Remark
1	产品型号 Ackage Type	SST-M49SSMD	
2	标称频率 Nominal Frequency	13.52127MHz	
3	振动模式 Mode of Vibration	AT—Fund (基频)	
4	常温频差 Frequency Tolerance	±10ppm	25±3℃ 测试 Measure at 25℃±3℃
5	工作温度范围 Operating Temperature Range	-20℃~+70℃	
6	频率稳定度 Frequency Stability	±30ppm	
7	储存温度范围 Storage Temperature Range	-40℃~+85℃	
8	负载电容 Load capacitance	15pF	
9	谐振电阻 Equivalent Series Resistance	50 Ω max	
10	激励功率 Drive Level	100 μ W max	
11	绝缘电阻 Insulation Resistance	500M Ω	At 250V _{DC}
12	静电容 Shunt Capacitance	5pF max	
13	年老化率 Aging Per Year	±5ppm	
14			
15			
16			
17			
18			

CRYSTAL UNIT SPECIFICATIONS

二、可靠性试验 Reliability test

No.	测试项目 Item	测试条件 Test Conditions	判定标准 Basis of Verdict
1	跌落冲击 Drop	75cm 高度自由下落到 3cm 厚度的硬质木板 3 次 3 Times Free Fall from 75cm height table to 3cm thickness hard wood board	$\Delta FL \leq \pm 5\text{ppm}$, $\Delta R \leq 5\text{ohm or } \leq 10\%$
2	模拟回流焊 Reflow	$240^{\circ}\text{C} \leq T \leq 265^{\circ}\text{C}$ $t=60 \pm 30\text{s}$ $T=260^{\circ}\text{C} \pm 5^{\circ}\text{C}$ $t=40 \pm 10\text{s}$ $T(\text{max}) = 265^{\circ}\text{C}$	$\Delta FL \leq \pm 5\text{ppm}$, $\Delta R \leq 5\text{ohm or } \leq 10\%$
3	可焊性 Solder	$260^{\circ}\text{C} \pm 5^{\circ}\text{C}$ 焊锡槽浸润 3 ± 0.5 秒 Temperature: $260^{\circ}\text{C} \pm 5^{\circ}\text{C}$ Time: 3 ± 0.5 Seconds	新锡覆盖率 $\geq 90\%$ the solder immersion surface $\geq 90\%$
4	耐焊接热 Solder Heating	$280^{\circ}\text{C} \pm 5^{\circ}\text{C}$ 焊锡槽浸润 10 ± 1 秒 Temperature: $280^{\circ}\text{C} \pm 5^{\circ}\text{C}$ Time: 10 ± 1 Seconds	$\Delta FL \leq \pm 5\text{ppm}$, $\Delta R \leq 5\text{ohm or } \leq 10\%$
5	高温储存 High temperature storage	$100^{\circ}\text{C} \pm 2^{\circ}\text{C}$ 烘箱中烘烤 96 ± 1 小时 Temperature: $100^{\circ}\text{C} \pm 5^{\circ}\text{C}$ Time: 96 ± 1 Hours	$\Delta FL \leq \pm 5\text{ppm}$, $\Delta R \leq 5\text{ohm or } \leq 10\%$
6	高温老化 High temperature ageing	$85^{\circ}\text{C} \pm 5^{\circ}\text{C}$ 之烘箱中烘烤 30 天 Temperature: $85^{\circ}\text{C} \pm 5^{\circ}\text{C}$, Time: 30days	$\Delta FL \leq \pm 5\text{ppm}$, $\Delta R \leq 5\text{ohm or } \leq 10\%$
7	低温储存 Low temperature storage	$-40^{\circ}\text{C} \pm 2^{\circ}\text{C}$ 环境中保持 96 ± 1 小时 Temperature: $-40^{\circ}\text{C} \pm 2^{\circ}\text{C}$ Time: 96 ± 1 Hours	$\Delta FL \leq \pm 5\text{ppm}$, $\Delta R \leq 5\text{ohm or } \leq 10\%$
8	恒温恒湿 Humidity	在湿度为 90~95%, 温度为 $40 \pm 2^{\circ}\text{C}$ 环境中保持 96 小时 Temp: $40^{\circ}\text{C} \pm 2^{\circ}\text{C}$, Humidity: 90~95% Times: 96 Hours	$\Delta FL \leq \pm 5\text{ppm}$, $\Delta R \leq 5\text{ohm or } \leq 10\%$
9	振动 Vibration	频率: $10 \sim 50\text{Hz}$, 幅度: 0.75mm 频率: $50\text{Hz} \sim 500\text{Hz}$, 加速度幅度: 98m/s^2 周期: $10-500-10\text{Hz}$, 15min 振动方向: X、Y、Z 振动时间: 每个方向 2 小时 Frequency: $10 \sim 50\text{Hz}$, Amplitude: 0.75mm Frequency: $50 \sim 500\text{Hz}$, Amplitude: 98m/s^2 Cycle time: $10-500-10\text{H}$, 15min Direction: X、Y、Z Duration: 2 Hours /direction	$\Delta FL \leq \pm 5\text{ppm}$, $\Delta R \leq 5\text{ohm or } \leq 10\%$

CRYSTAL UNIT SPECIFICATIONS

三、外形尺寸 Outline Dimensions (unit: mm)



NO.	规格	H
1.	M49S -SMD	2.3Max

四、印字 Marking

当前字样:

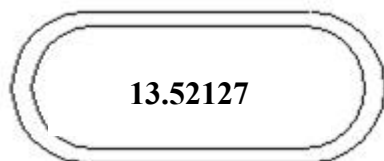

CRYSTAL UNIT SPECIFICATIONS

五、包装方式 Packing

T/R: 3000pcs/ REEL

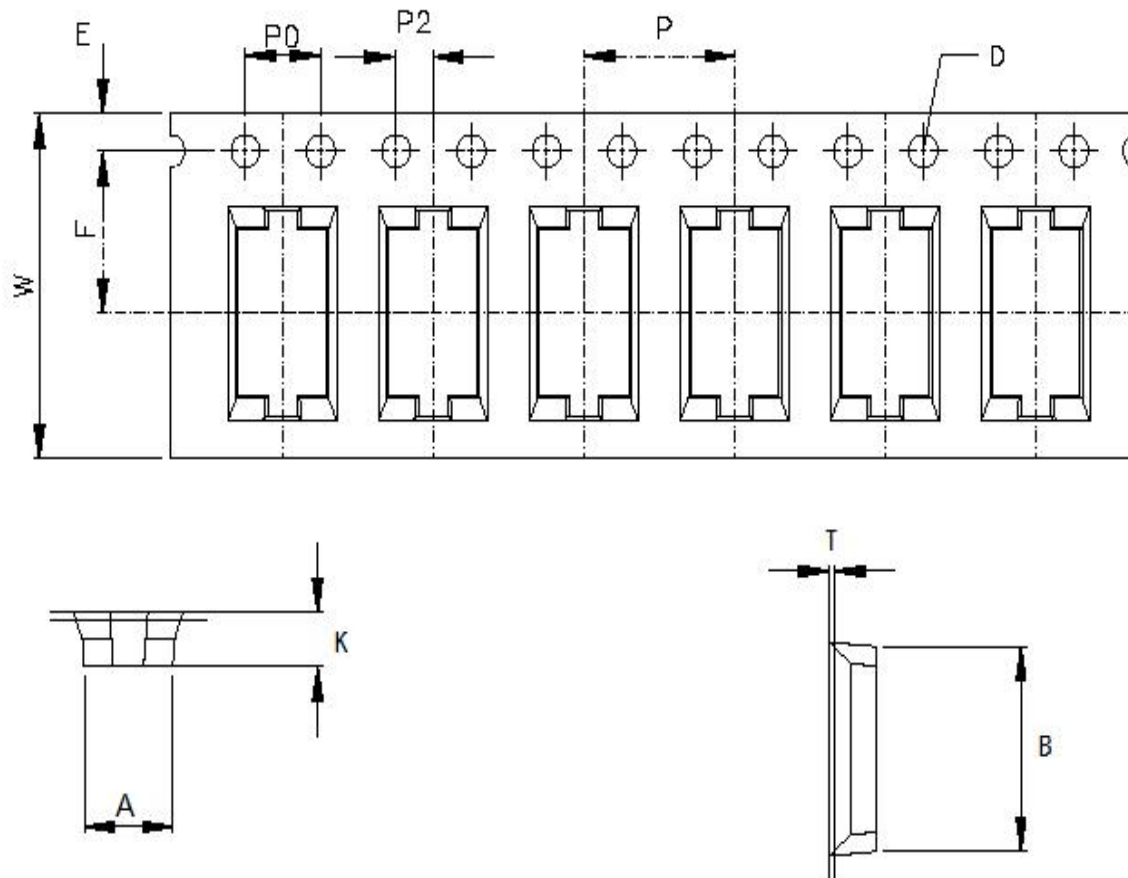

单位 units : mm:

Model	A	B	D	E	F	P	P0	T	W
SST-47SMD	4.7±0.1	9.5±0.1	Φ1.5	1.75±0.1	7.5±0.1	8.0±0.1	4.0±0.1	0.3±0.05	16±0.3

CRYSTAL UNIT SPECIFICATIONS

SPEC 1	12	16	24	32	44	56	72	88
C1±1	330	330	330	330	330	330	330	330
A±0.2	2.3	2.3	2.3	2.3	2.3	2.3	2.3	2.3
B±0.2	10.0	10.0	10.0	10.0	10.0	10.0	10.0	10.0
H+2.0	12.5	16.5	24.5	32.5	44.5	56.5	72.5	88.5
T±0.2	2.1	2.1	2.1	2.1	2.1	2.1	2.1	2.1
D±0.5	∅100	∅100	∅100	∅100	∅100	∅100	∅100	∅100

