

AX88772C Product Introduction

Revision 1.10
May 15th, 2013

Revision History

Revision	Date	Description
V0.10	2013/03/27	Preliminary release
V1.00	2013/05/08	1. Modified some descriptions in Section 1, 3, 8.
V1.10	2013/05/15	1. Modified some descriptions in Section 3, 4.

Table of Contents

1. Introduction	4
2. Block Diagram	5
2-1. <i>Typical System Block Diagrams</i>	<i>6</i>
3. Selection Guide	8
4. Ordering Information	9
5. Target Applications	10
6. Mass Production Solutions	11
6-1. <i>Windows SROM Programming Tool</i>	<i>11</i>
6-2. <i>Windows Production Test Tool</i>	<i>12</i>
7. AX88772C Demo Boards	13
7-1. <i>AX88772C USB to 100Base-TX Ethernet Demo Board</i>	<i>13</i>
7-2. <i>AX88772C USB to 100Base-TX Ethernet (with RMII) Demo Board</i>	<i>14</i>
7-3. <i>AX88772C USB to 100Base-FX 1x9 SC Ethernet Demo Board</i>	<i>15</i>
7-4. <i>AX88772C USB to 100Base-FX POF Ethernet Demo Board</i>	<i>16</i>
8. Related Technical Archives	18

List of Figures

Figure 1. Block Diagram	5
Figure 2. Selection Guide	8
Figure 3. Ordering Information	9
Figure 4. Target Applications	10
Figure 5. Windows SROM Programming Tool	11
Figure 6. Windows Production Test Tool	12
Figure 7. AX88772C USB to 100Base-TX Ethernet Demo Board	13
Figure 8. AX88772C USB to 100Base-TX Ethernet (with RMII) Demo Board	14
Figure 9. AX88772C USB to 100Base-FX 1x9 SC Ethernet Demo Board	15
Figure 10. AX88772C USB to 100Base-FX POF Ethernet Demo Board	16
Figure 11. AX88772C USB to 100Base-TX/FX Ethernet with RMII Demo Boards Jumper Setting Table	17
Figure 12. Related Technical Archives	19
Figure 13. Technical Archives Availability Type	19

1. Introduction

The AX88772C USB 2.0 to 10/100M Fast Ethernet controller with Microsoft AOAC(Always On Always Connected) support is a high performance and highly integrated ASIC which enables a low cost, small form factor, and simple plug-and-play Fast Ethernet network connection capability for desktops, notebook PCs, Ultrabooks, cradles/port replicators/docking stations, game consoles, digital-home appliances, and any embedded system using a standard USB port.

The AX88772C can be used in any embedded system with a USB host microcontroller requiring a twisted pair physical network connection. Featuring a USB interface (compliant with USB specification V2.0 and V1.1) to communicate with a USB Host Controller, the AX88772C also integrates on-chip Ethernet MAC and PHY (IEEE802.3 and IEEE802.3u compatible) and embedded memory. Additionally, the AX88772C needs only a single 25MHz crystal to drive both the USB and Ethernet PHYs.

The AX88772C offers a wide array of features including IPv4/IPv6 checksum offload engine, Protocol Offload(ARP & NS), HP Auto-MDIX, and IEEE 802.3x and back-pressure flow control. The AX88772C also offers multiple power management Wake-on-LAN features, including Magic Packet, Microsoft Wakeup Frame, Link Status Change, 32 Microsoft Wakeup Patterns and Wakeup Packet Indication that allows the AOAC platform to enter a low-power “Connected Standby” state and wake on a desired network pattern.

The AX88772C provides an optional Multi-Function-Bus portion A and B (MFA and MFB) for external PHY or external MAC for different application purposes. The MFA/MFB can be a reduce-media-independent interface (RMII) for implementing HomePlug, HomePNA, etc. functions. The MFA/MFB can also be a Reverse Reduced-MII (Reverse-RMII) for glueless MAC-to-MAC connections to any MCU with Ethernet MAC RMII interface. In addition, the MFA/MFB can be configured as general purpose I/O.

The following URL provides detailed online resources of ASIX Electronics high-speed USB-to-LAN solutions:

(Refer to <http://www.asix.com.tw/products.php?op=ProductList&PLine=71>)

USB 2.0 to 10/100M Fast Ethernet Controller with Microsoft AOAC Support

[AX88772C](#) -- USB 2.0 to 10/100M Fast Ethernet Controller with Microsoft AOAC Support

This document provides an overview of AX88772C USB 2.0 to 10/100M Fast Ethernet Controller with Microsoft AOAC Support product.

2. Block Diagram

The following is AX88772C block diagram,

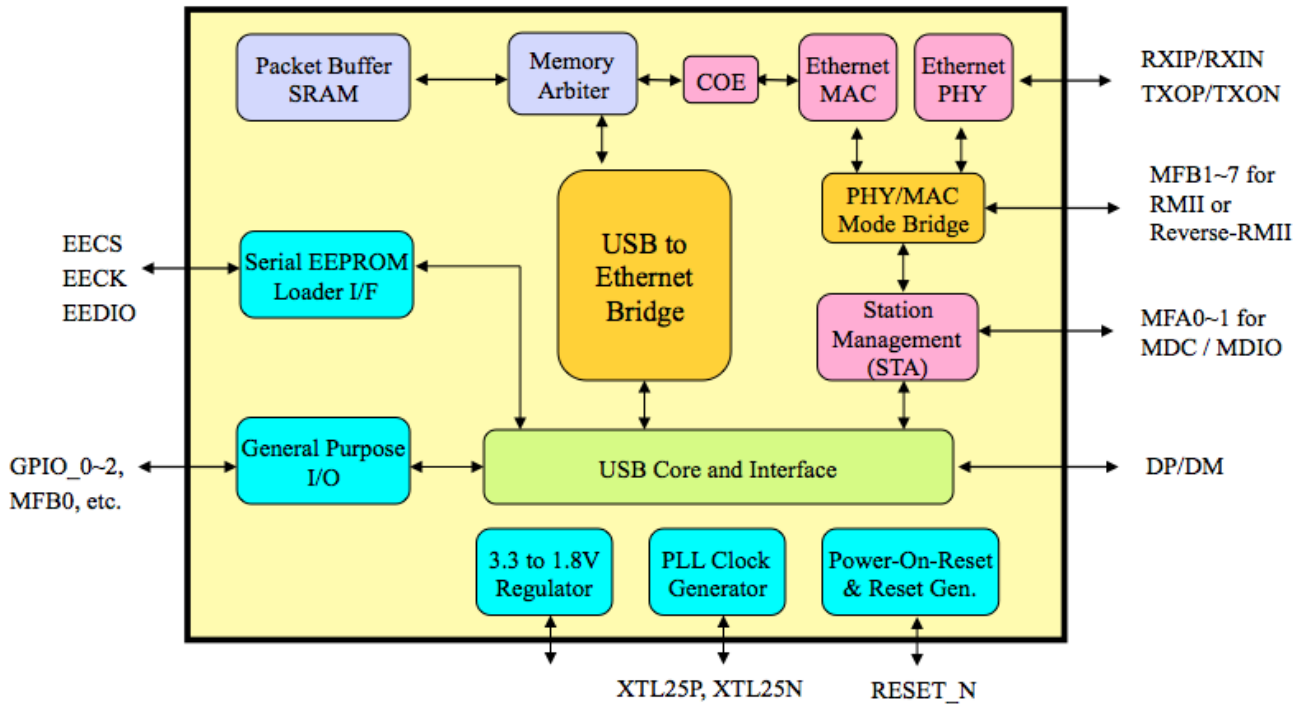

Figure 1. Block Diagram

2-1. Typical System Block Diagrams

- Hosted by USB to operate with internal Ethernet PHY only

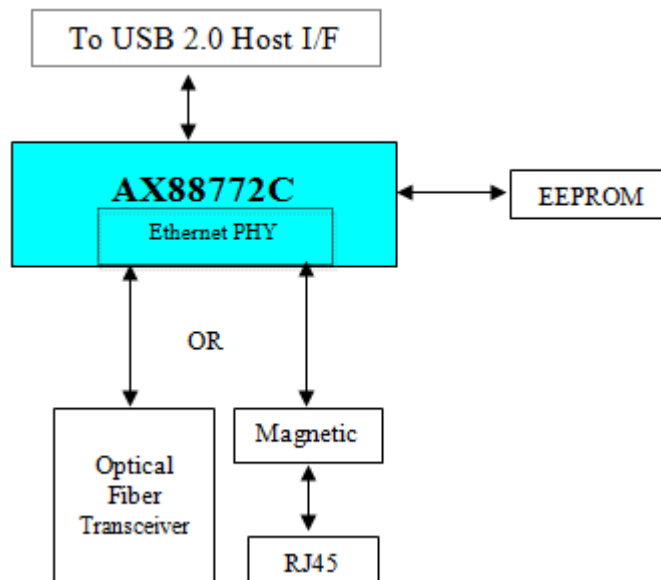

Figure 2 : USB 2.0 to LAN Adaptor (MAC mode)

- Hosted by USB to operate with either internal Ethernet PHY or RMII (in MAC mode)

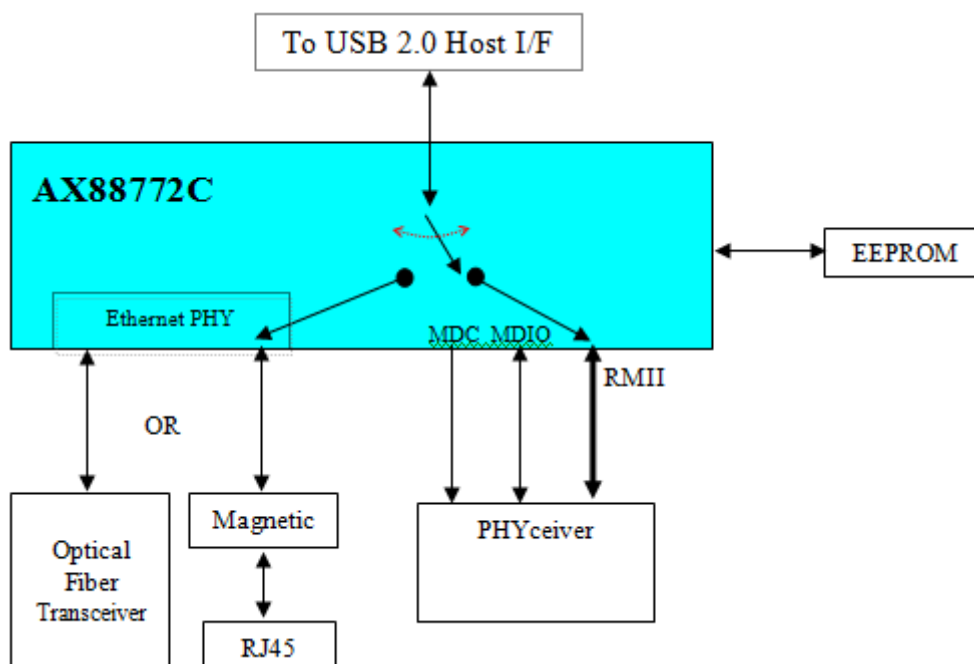

Figure 3 : USB 2.0 to Fast Ethernet and external PHYceiver Combo (MAC mode)

- Hosted by USB to operate with either internal Ethernet PHY (in MAC mode) or Reverse-RMII (in PHY mode)

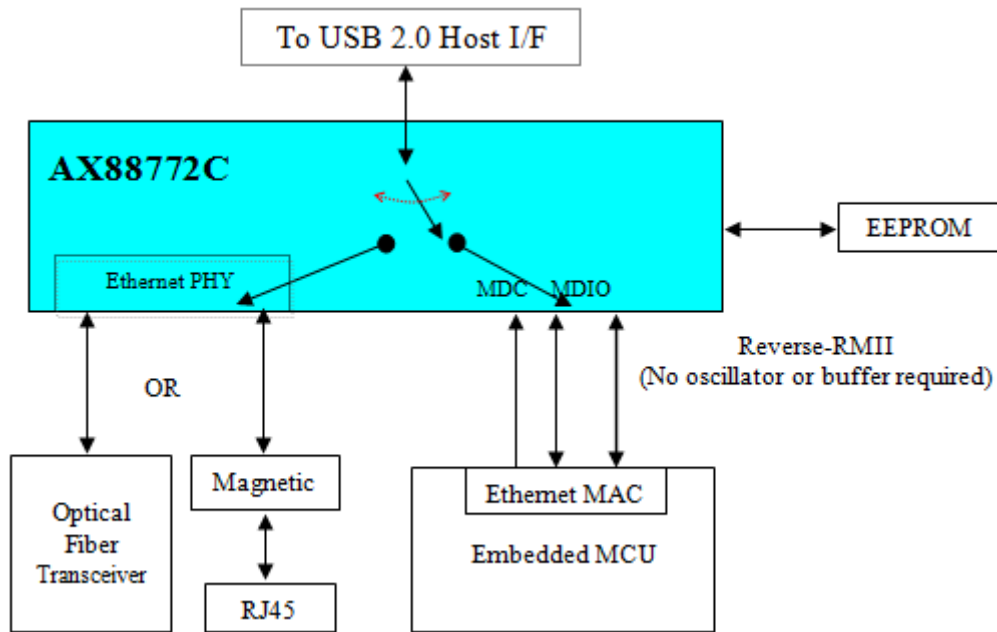

Figure 4 : Bridging Embedded MCU to USB 2.0 Host Interface (PHY mode)

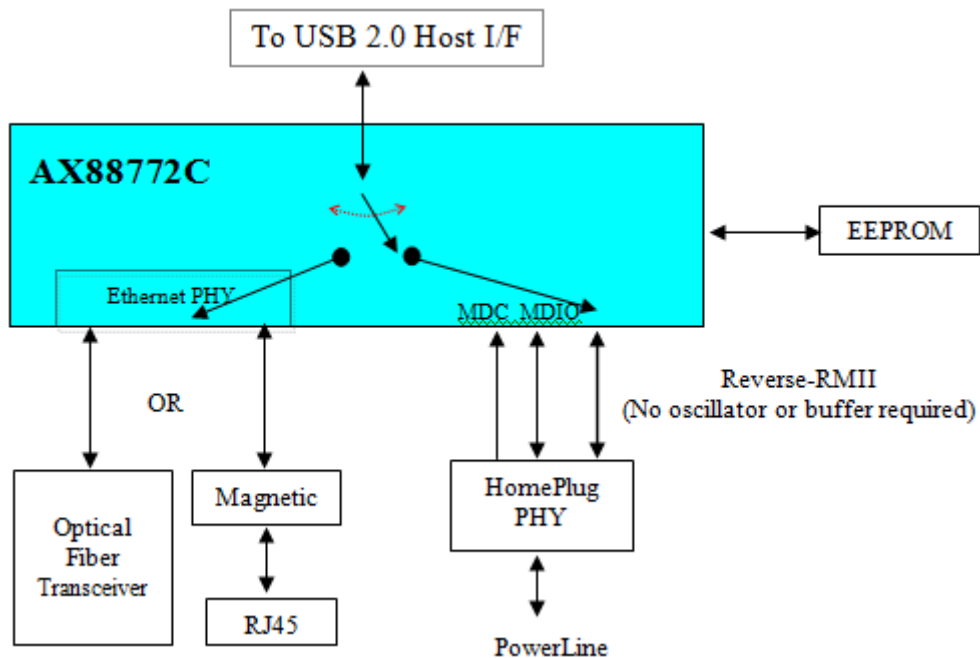

Figure 5 : USB 2.0 to HomePlug Adaptor (PHY mode)

3. Selection Guide

The following is the selection guide of ASIX Electronics USB to Ethernet family for different requirement applications. Please visit ASIX Electronics' High-Speed USB-to-LAN product web page (<http://www.asix.com.tw/products.php?PLine=71>) and contact ASIX's Sales (sales@asix.com.tw) for details.

Part No.	USB Speed	USB Hub	Ethernet MAC/PHY (Mbps)	Microsoft AOAC	MAC Interface	Crossover Detection and Auto-correction
AX88179	Super (3.0)	-	10/100/1000	-	-	v
AX88178A	High (2.0)	-	10/100/1000	-	-	v
AX88178	High (2.0)	-	10/100/1000 (MAC only)	-	MII/GMII/RGMII	-
AX88772C	High (2.0)	-	10/100	v	RMII/Rev-RMII(Optional)	v
AX88772B	High (2.0)	-	10/100	-	RMII/Rev-RMII(Optional)	v
AX88772A	High (2.0)	-	10/100	-	-	v
AX88172A	High (2.0)	-	10/100	-	(Rev-)MII/Rev-RMII	v
AX88772	High (2.0)	-	10/100	-	MII	-
AX88760	High (2.0)	3-Port	10/100	-	-	v

Part No.	IP/TCP/UDP Checksum	Wake-on-LAN	Serial Interface	Temperature Range (°C)	Package
AX88179	v	v	-	0 ~ +70	QFN-68
AX88178A	v	v	-	0 ~ +70	QFN-68
AX88178	-	v	-	0 ~ +70	LQFP-128
AX88772C	v	v	-	0 ~ +70	LQFP-64
AX88772B	v	v	-	0 ~ +70/ -45 ~ +85	LQFP-64
AX88772A	-	v	I ² C, SPI UART	0 ~ +70	LQFP-64
AX88172A	-	v	I ² C, SPI UART	0 ~ +70	TQFP-80
AX88772	-	v	-	0 ~ +70	LQFP-128
AX88760	-	v	-	0 ~ +70	LQFP-100

Figure 2. Selection Guide

4. Ordering Information

The following are the ordering information of AX88772C silicon and AX88772C demo boards. Please contact ASIX's Sales (sales@asix.com.tw) for more details.

Part Number	Description
AX88772CLF	64 PIN, LQFP Package, Commercial grade 0°C to +70 °C (Green, Lead-Free)

AX88772C Demo Boards	Description
AX88772C USB to 100Base-TX Ethernet Demo Board	This is a USB dongle for AX88772C USB to 100Base-TX Ethernet application
AX88772C USB to 100Base-TX Ethernet (with RMII) Demo Board	This is a general-purpose demo board for AX88772C USB to 100Base-TX Ethernet (with optional RMII/Rev-RMII interface) application
AX88772C USB to 100Base-FX 1x9 SC Ethernet Demo Board	This is a general-purpose demo board for AX88772C USB to 100Base-FX 1x9 SC Fiber Ethernet (with optional RMII/Rev-RMII interface) application
AX88772C USB to 100Base-FX POF Ethernet Demo Board	This is a general-purpose demo board for AX88772C USB to 100Base-FX POF (Plastic Optical Fiber) Fiber Ethernet (with optional RMII/Rev-RMII interface) application

Figure 3. Ordering Information

5. Target Applications

The following are some PC/Internet and consumer electronics target applications for your reference.

PC/Internet



Consumer Electronics



Figure 4. Target Applications

6. Mass Production Solutions

To support the mass production for those products using AX88772C chip, ASIX provides the Windows SROM Programming Tool and Windows Production Test Tool solutions for AX88772C customers. This chapter provides a brief introduction for both solutions. Please refer to “AX88772C EEPROM User Guide” for details.

6-1. Windows SROM Programming Tool

ASIX Electronics provides a Windows SROM Programming tool for users to easily program the Serial EEPROM of AX88772C on a typical Windows PC. This AX88772C Windows SROM Programming Tool supports to customize the MAC address, Serial Number, Vendor ID and Product ID, etc. for AX88772C based application systems in mass production.

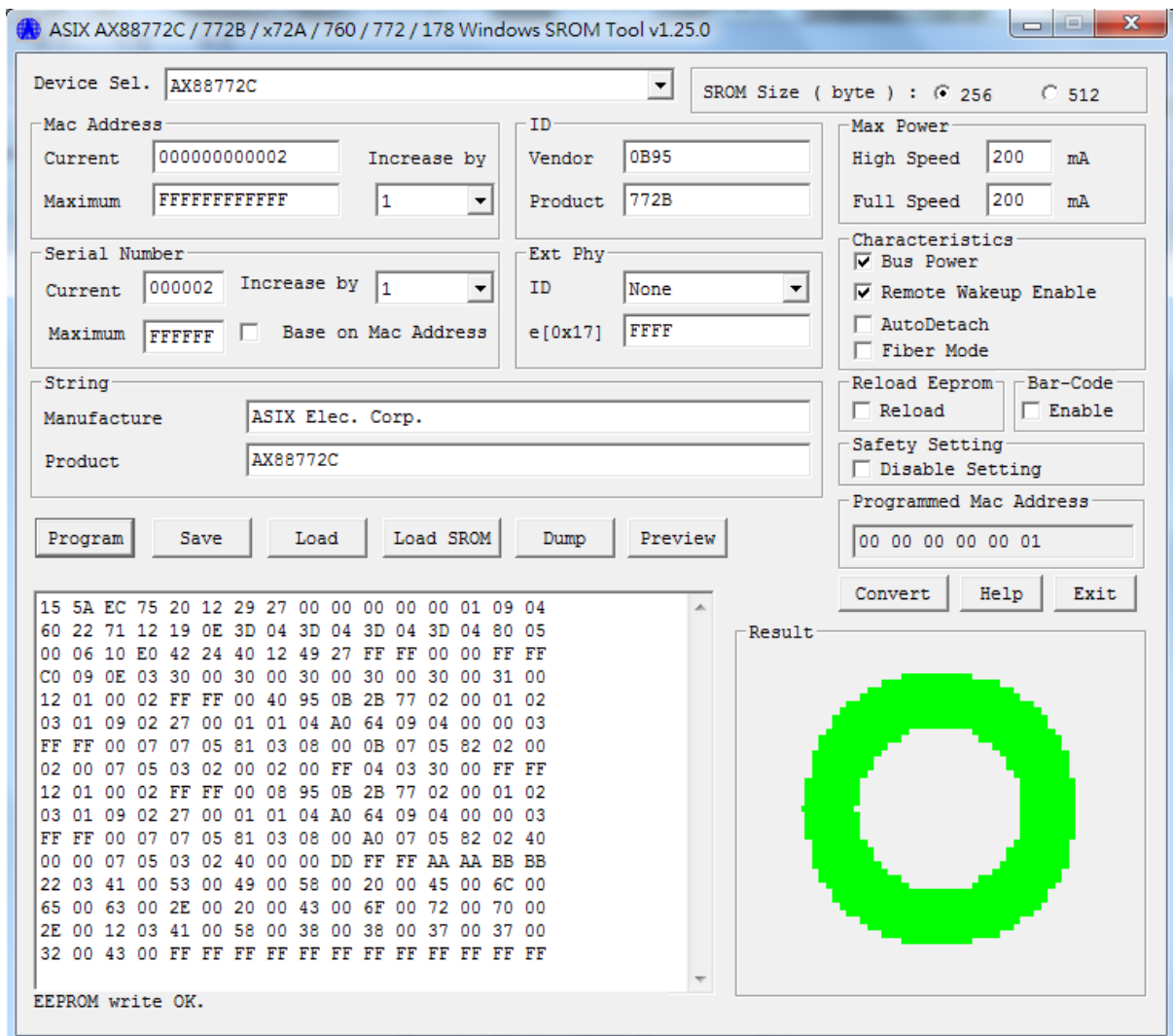

Figure 5. Windows SROM Programming Tool

6-2. Windows Production Test Tool

ASIX Electronics provides a Windows Production Test tool for users to run some basic network function tests and program the EEPROM of their AX88772C based application systems during production. This tool is used for testing the USB to Ethernet Network Adapter product that uses ASIX AX88772C chip.

This tool supports to send/receive packets in different Ethernet speed modes, and program EEPROM. This tool can be run on a Windows PC, which installs the special AX88772C Windows test driver. This tool also needs a separate server PC to run the test server tool. The test server tool on server PC can receive packets from the “device under test” product, and then reply back.

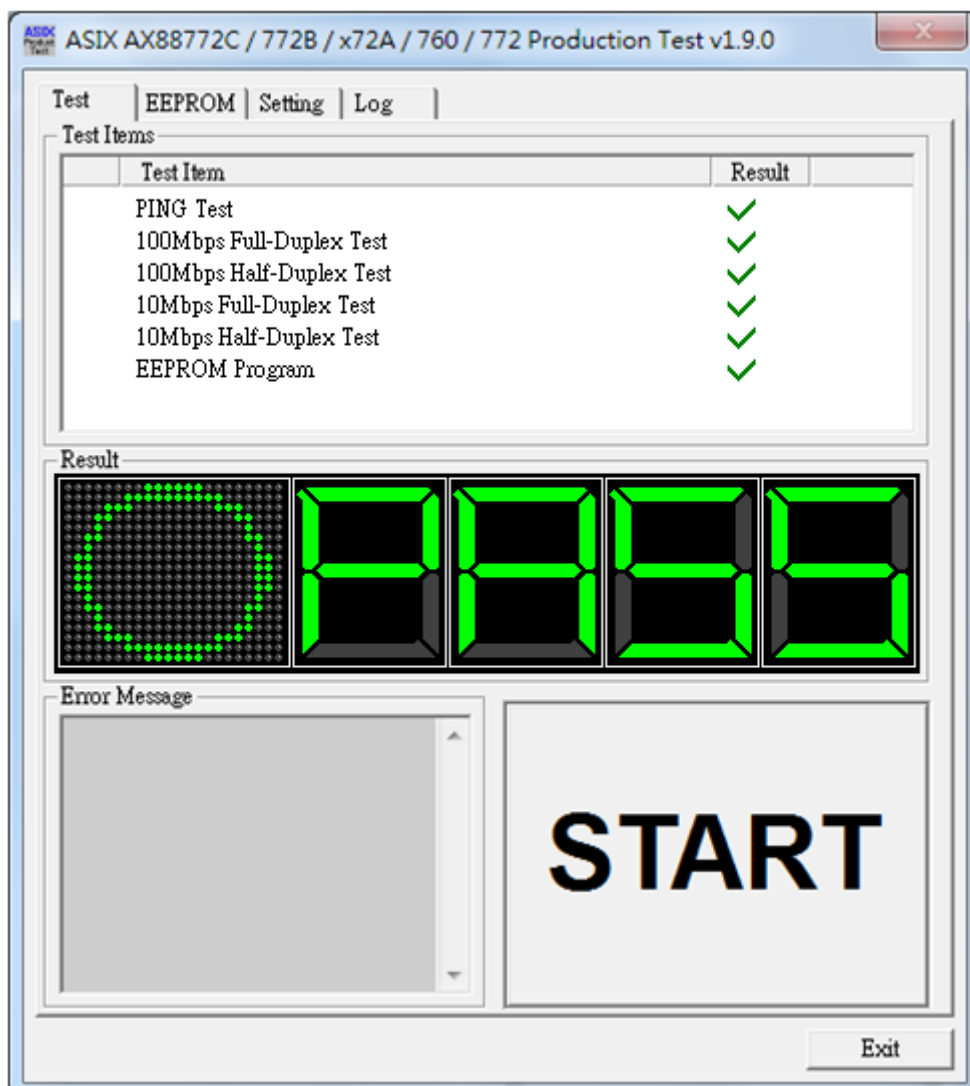

Figure 6. Windows Production Test Tool

7. AX88772C Demo Boards

ASIX Electronics provides several AX88772C demo boards for users to evaluate the basic functions of AX88772C on different target applications. If you need to purchase the AX88772C demo boards, please contact ASIX's Sales (sales@asix.com.tw) for more details.

7-1. AX88772C USB to 100Base-TX Ethernet Demo Board

The following is the picture of AX88772C USB to 100Base-TX Ethernet demo board for your reference.

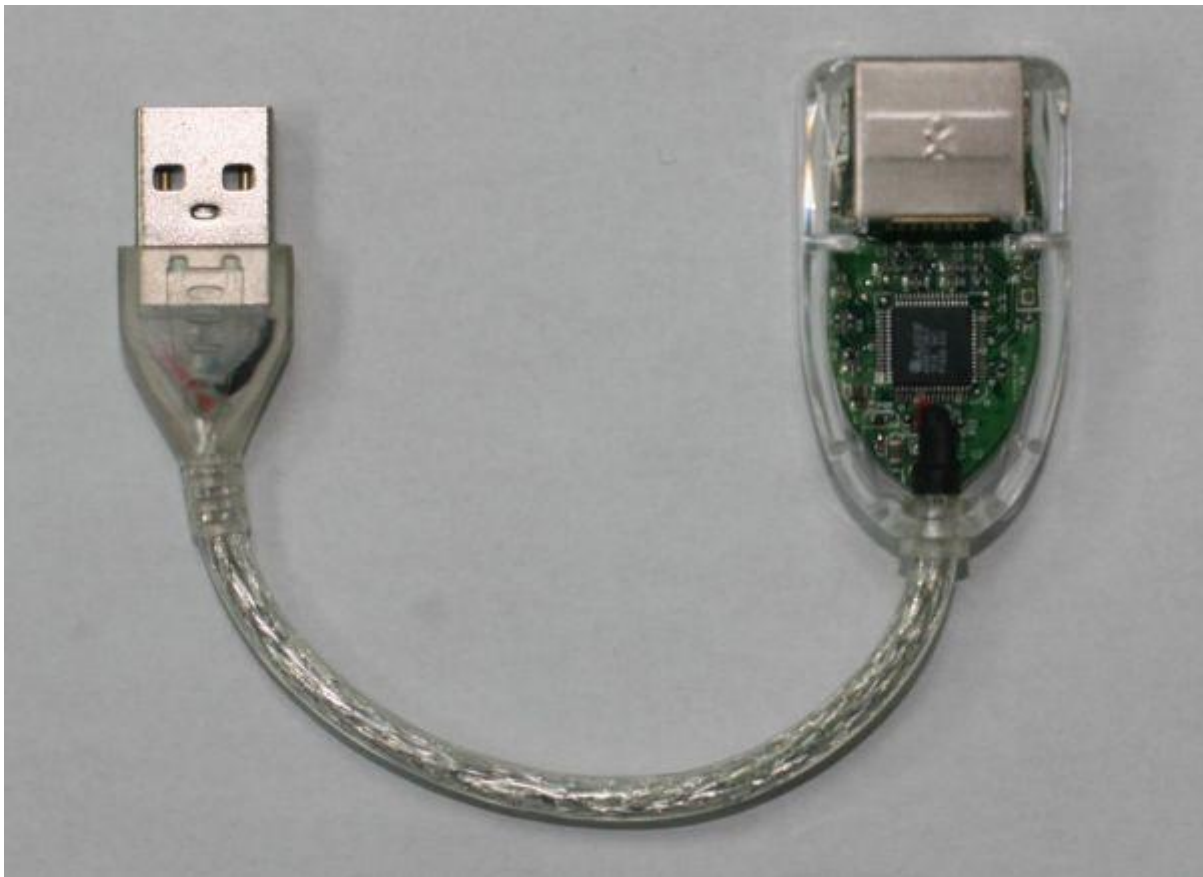

Figure 7. AX88772C USB to 100Base-TX Ethernet Demo Board

7-2. AX88772C USB to 100Base-TX Ethernet (with RMI) Demo Board

The following is the picture of AX88772C USB to 100Base-TX Ethernet (with RMI) demo board for your reference.

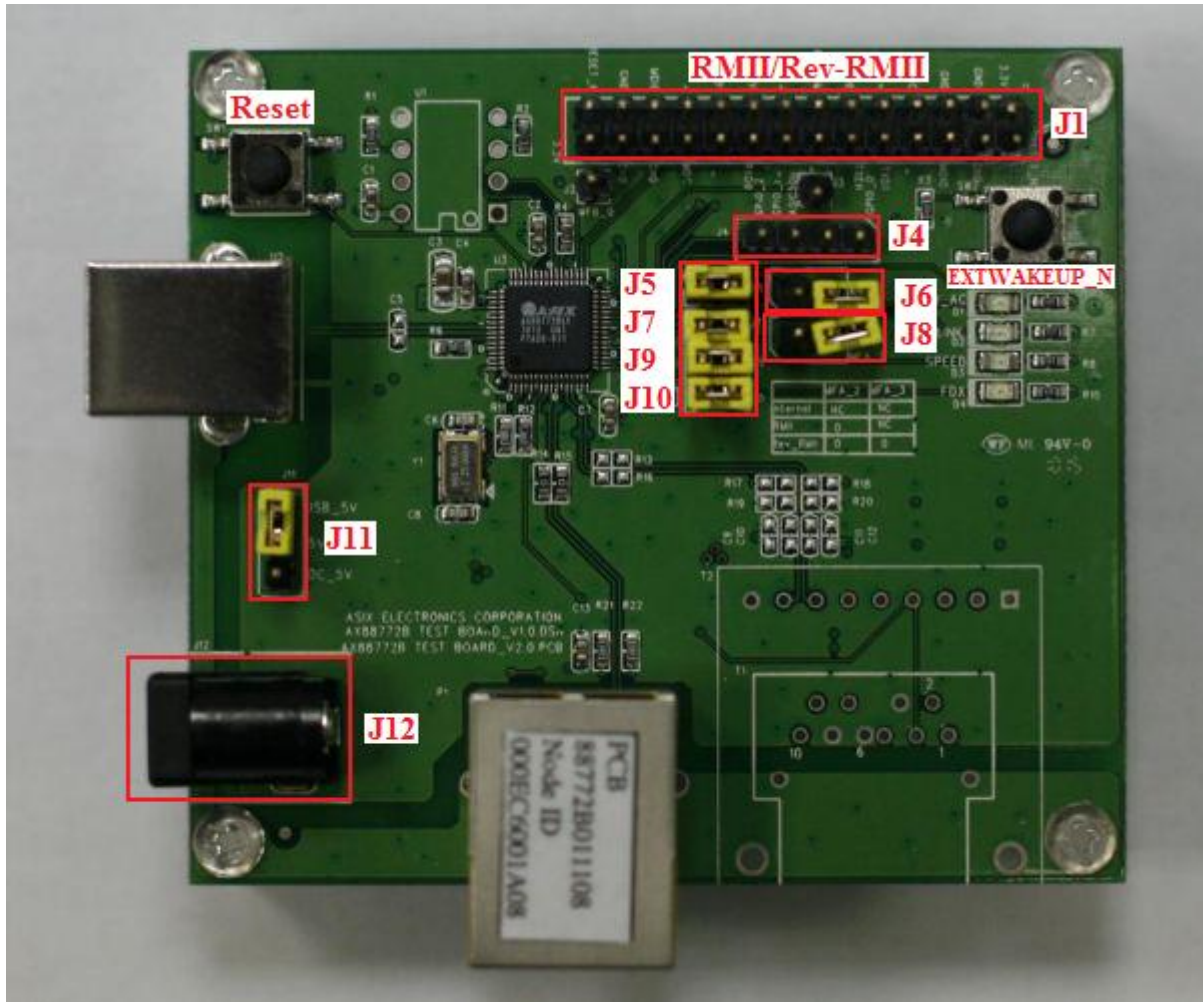

Figure 8. AX88772C USB to 100Base-TX Ethernet (with RMI) Demo Board

7-3. AX88772C USB to 100Base-FX 1x9 SC Ethernet Demo Board

The following is the picture of AX88772C USB to 100Base-FX 1x9 SC Ethernet demo board for your reference.

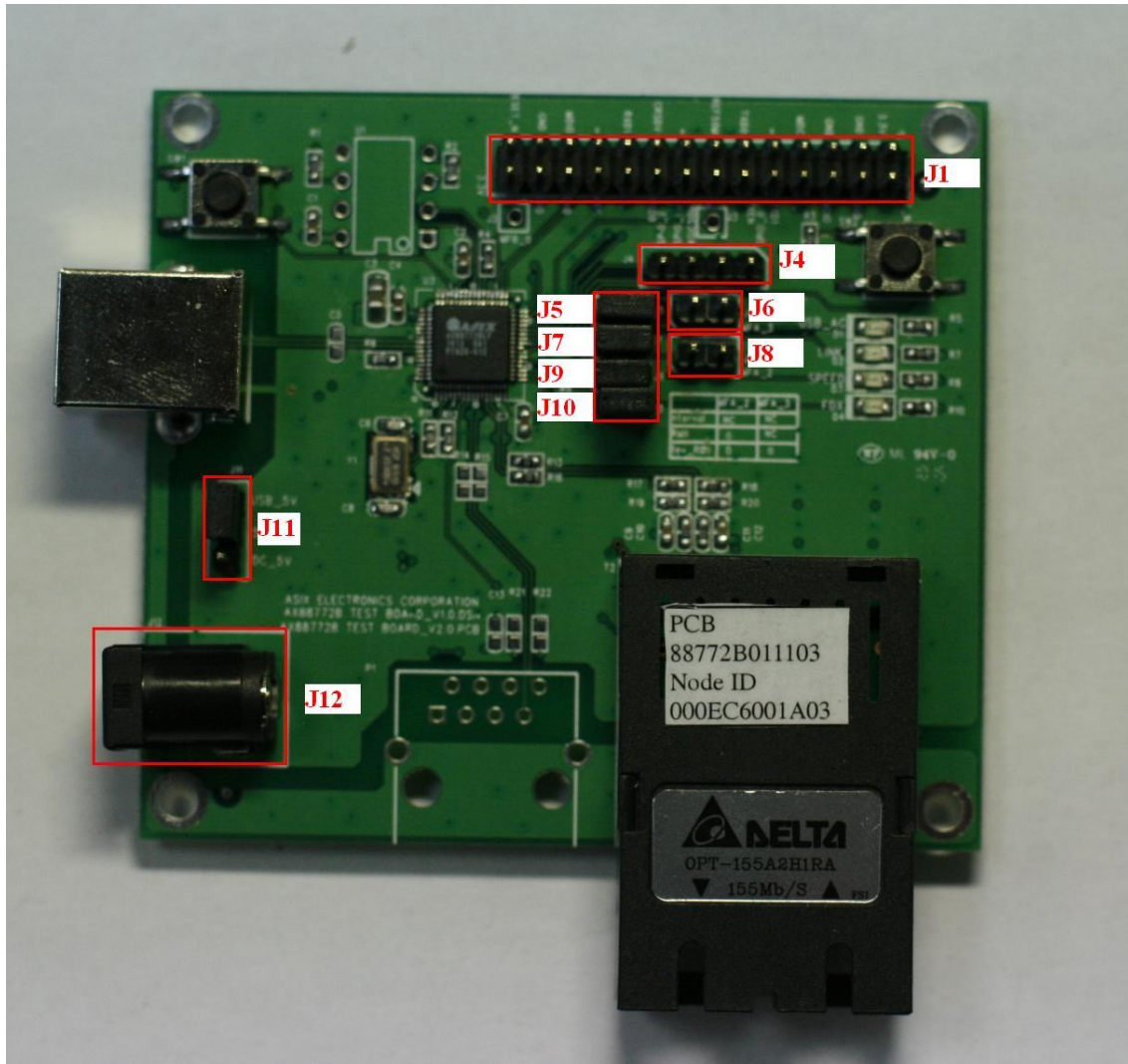

Figure 9. AX88772C USB to 100Base-FX 1x9 SC Ethernet Demo Board

7-4. AX88772C USB to 100Base-FX POF Ethernet Demo Board

The following is the picture of AX88772C USB to 100Base-FX POF Ethernet demo board for your reference.

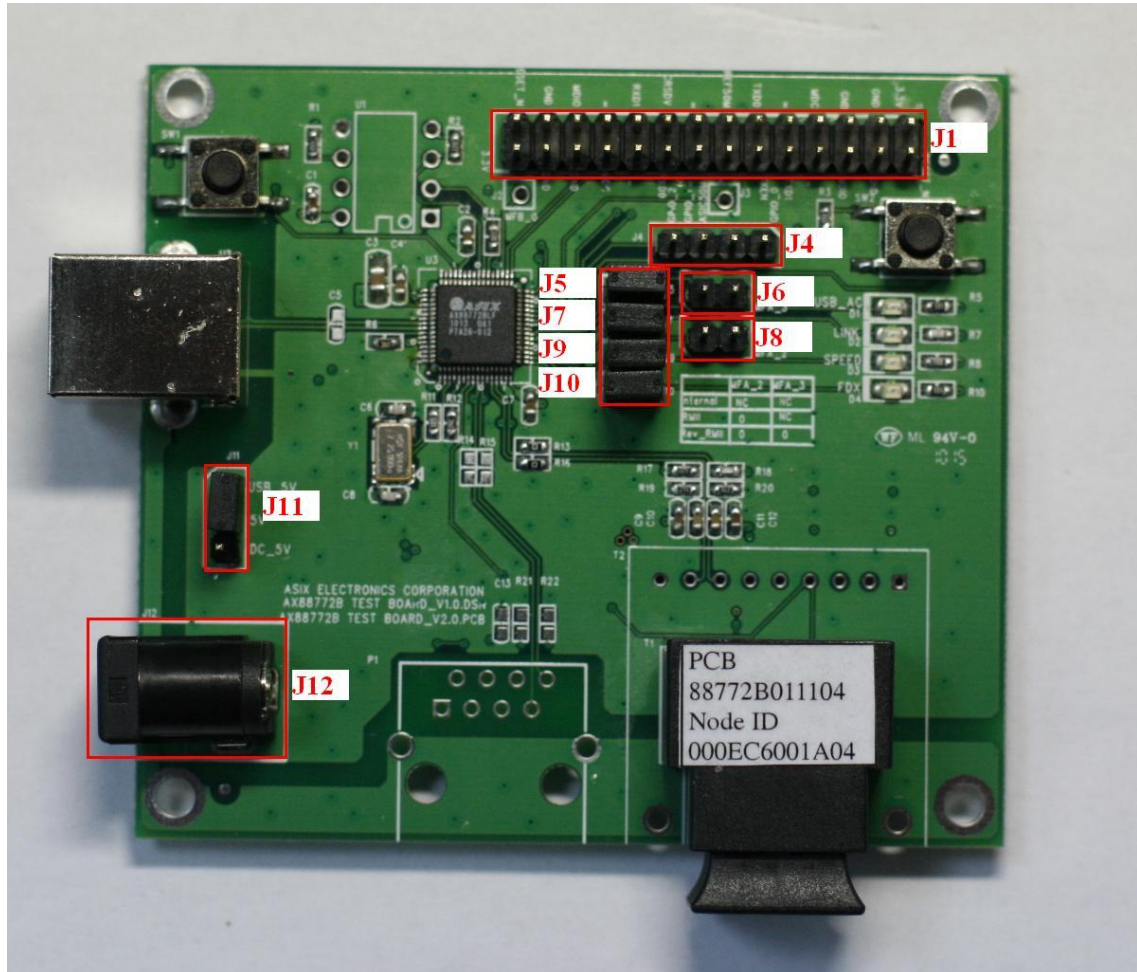

Figure 10. AX88772C USB to 100Base-FX POF Ethernet Demo Board

The following is the jumper configuration table of the AX88772C USB to 100Base-TX/FX Ethernet (with RMII) demo boards.





















Jumper	Setting	Description
J1		The J1 is the RMII/Reverse-RMII interface headers. Please refer to AX88772C USB to 100Base-TX/FX Ethernet (with RMII) Demo Boards Reference Schematic for details.
J4	J4  1 2 3 4 Pole #1: GPIO2 Pole #2: VCC 3.3V Pole #3: GPIO1 Pole #4: GPIO0/PME	AX88772C GPIO Pins
J6/J8	J6  J8  (Default)	Set AX88772C to Internal Ethernet PHY
	J6  J8 	Set AX88772C to RMII mode
	J6  J8 	Reserved
	J6  J8 	Set AX88772C to Reverse-RMII mode
J5/J7/J9/J10	J5  J7  J9  J10  J5 : PHY_N J7 : RMII_N J9 : MDIO J10 : MDC	The multi-function pins (PHY_N, RMII_N, MDIO, MDC) for RMII/Reverse-RMII pins.
	J5  J7  J9  J10  (Default) J5 : MFA3 J7 : MFA2 J9 : MFA1 J10 : MFA0	The multi-function pins (MFA0 ~ MFA3) for LED display purpose. Please refer to PIN configuration of MFA in section 2.2 of AX88772C datasheet for details.
J11/J12	J11  1 2 3 (Default) Pole #1: USB_5V Pole #2: 5V Pole #3: DC_5V	Set AX88772C USB to 100Base-TX/FX Ethernet (with RMII) demo boards to Bus-power mode. The J12 connector doesn't need to be connected.
	J11  1 2 3	Set AX88772C USB to 100Base-TX/FX Ethernet (with RMII) demo boards to Self-power mode. The J12 connector should be connected to a 5V power adapter.

Figure 11. AX88772C USB to 100Base-TX/FX Ethernet with RMII Demo Boards Jumper Setting Table

8. Related Technical Archives

The following is the AX88772C technical archives table.

AX88772C Technical Archives	Type	Availability
AX88772C Product Introduction	Document	This document
AX88772C Product Brief	Document	Public Release
AX88772C USB to 100Base-TX Ethernet Demo Board Reference Schematic	Schematic	Public Release
AX88772C USB to 100Base-TX/FX Ethernet with RMII Demo Boards Reference Schematic	Schematic	Public Release
AX88772C Windows 8 64-bit Driver (Note1)	Driver	Public Release
AX88772C Windows 8 32-bit Driver (Note1)	Driver	Public Release
AX88772C Windows 7 64-bit Driver	Driver	Public Release
AX88772C Windows 7 32-bit Driver	Driver	Public Release
AX88772C Windows XP/Vista 64-bit Driver	Driver	Public Release
AX88772C Windows XP/Vista 32-bit Driver	Driver	Public Release
AX88772C Apple Mac OSX 10.5 to 10.8 Drivers	Driver	Public Release
AX88772C Android/Linux Driver	Driver	Public Release
AX88772C WinCE 7.0 Driver	Driver	Public Release
AX88772C WinCE 6.0 Driver	Driver	Public Release
AX88772C WinCE 5.0/Mobile 5/Mobile 6 Driver	Driver	Public Release
AX88772C Datasheet	Document	MyASIX Membership
AX88772C USB-to-LAN Application Design Guide	Document	MyASIX Membership
AX88772C USB to 100Base-TX Ethernet Demo Board PCB file	PCB	MyASIX Membership
AX88772C USB to 100Base-TX/FX Ethernet with RMII Demo Boards PCB file	PCB	MyASIX Membership
AX88772C USB to 100Base-TX Ethernet Demo Board Gerber files	Gerber	MyASIX Membership
AX88772C USB to 100Base-TX/FX Ethernet with RMII Demo Boards Gerber files	Gerber	MyASIX Membership
AX88772C USB to 100Base-TX Ethernet Demo Board BOM File	BOM	MyASIX Membership
AX88772C USB to 100Base-TX Ethernet with RMII Demo Board BOM file	BOM	MyASIX Membership
AX88772C USB to 100Base-FX 1x9 SC Ethernet Demo Board BOM file	BOM	MyASIX Membership
AX88772C USB to 100Base-FX POF Ethernet Demo Board BOM file	BOM	MyASIX Membership
AX88772C IBIS Model	IBIS	MyASIX Membership
AX88772C EEPROM/Manufacture User Guide	Document	Contact ASIX Sales
AX88772C Windows SROM Programming Tool	Utility	Contact ASIX Sales
AX88772C Windows Production Test Tool	Utility	Contact ASIX Sales
AX88772C Linux SROM Programming Tool	Utility	Contact ASIX Sales
AX88772C Windows IEEE 802.3 Compliant Test	Utility	Contact ASIX Sales

Tool		
AX88772C Performance Test Report	Report	Contact ASIX Sales
AX88772C RoHS Report	Report	Contact ASIX Sales
AX88772C Reliability Report	Report	Contact ASIX Sales
AX88772C USB-IF Compliant Test Report	Report	Contact ASIX Sales
AX88772C IEEE 802.3 Compliant Test Reports	Report	Contact ASIX Sales

*Note 1: The Windows 8 32-bit/64-bit systems already support AX88772C/AX88772B/AX88772A/AX88760/AX88772 inbox drivers.

Figure 12. Related Technical Archives

Availability Type	Description
Public Release	Please download the technical archives from AX88772C product web page directly.
MyASIX Membership	Please register MyASIX membership from MyASIX register web page (http://www.asix.com.tw/RegLogin.php?mod=thisis) first and then download the technical archives from AX88772C product web page .
Contact ASIX Sales	Please contact ASIX's Sales (sales@asix.com.tw) for more details.

Figure 13. Technical Archives Availability Type



**4F, No.8, Hsin Ann Rd., Hsinchu Science Park,
Hsinchu, Taiwan, R.O.C.**

TEL: +886-3-5799500

FAX: +886-3-5799558

Email: support@asix.com.tw

Web: <http://www.asix.com.tw>