

# Dual General Purpose Transistors

## NPN Duals

### BC846BDW1, BC847BDW1, BC848CDW1

These transistors are designed for general purpose amplifier applications. They are housed in the SOT-363/SC-88 which is designed for low power surface mount applications.

#### Features

- S and NSV Prefixes for Automotive and Other Applications Requiring Unique Site and Control Change Requirements; AEC-Q101 Qualified and PPAP Capable
- These Devices are Pb-Free, Halogen Free/BFR Free and are RoHS Compliant\*

#### MAXIMUM RATINGS

Rating	Symbol	BC846	BC847	BC848	Unit
Collector - Emitter Voltage	$V_{CEO}$	65	45	30	V
Collector - Base Voltage	$V_{CBO}$	80	50	30	V
Emitter - Base Voltage	$V_{EBO}$	6.0	6.0	5.0	V
Collector Current - Continuous	$I_C$	100	100	100	mAdc

Stresses exceeding those listed in the Maximum Ratings table may damage the device. If any of these limits are exceeded, device functionality should not be assumed, damage may occur and reliability may be affected.

#### THERMAL CHARACTERISTICS

Characteristic	Symbol	Max	Unit
Total Device Dissipation Per Device	$P_D$	380	mW
FR-5 Board (Note 1)		250	mW
$T_A = 25^\circ\text{C}$ Derate Above $25^\circ\text{C}$		3.0	mW/ $^\circ\text{C}$
Thermal Resistance, Junction to Ambient	$R_{\theta JA}$	328	$^\circ\text{C}/\text{W}$
Junction and Storage Temperature Range	$T_J, T_{stg}$	-55 to +150	$^\circ\text{C}$

1. FR-5 = 1.0 x 0.75 x 0.062 in



SOT-363/SC-88  
CASE 419B  
STYLE 1

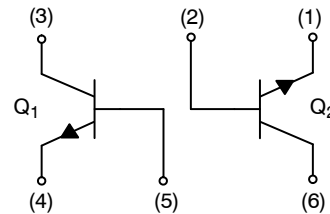

#### MARKING DIAGRAM

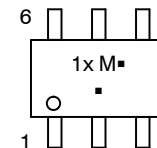

1x = Specific Device Code  
x = B, F, G, L  
M = Date Code  
▪ = Pb-Free Package

(Note: Microdot may be in either location)

#### ORDERING INFORMATION

See detailed ordering and shipping information in the package dimensions section on page 10 of this data sheet.

\*For additional information on our Pb-Free strategy and soldering details, please download the onsemi Soldering and Mounting Techniques Reference Manual, SOLDERRM/D.

# BC846BDW1, BC847BDW1, BC848CDW1

## ELECTRICAL CHARACTERISTICS ( $T_A = 25^\circ\text{C}$ unless otherwise noted)

Characteristic	Symbol	Min	Typ	Max	Unit
<b>OFF CHARACTERISTICS</b>					
Collector – Emitter Breakdown Voltage ( $I_C = 10\text{ mA}$ ) BC846 BC847 BC848	$V_{(BR)CEO}$	65 45 30	– – –	– – –	V
Collector – Emitter Breakdown Voltage ( $I_C = 10\ \mu\text{A}$ , $V_{EB} = 0$ ) BC846 BC847 BC848	$V_{(BR)CES}$	80 50 30	– – –	– – –	V
Collector – Base Breakdown Voltage ( $I_C = 10\ \mu\text{A}$ ) BC846 BC847 BC848	$V_{(BR)CBO}$	80 50 30	– – –	– – –	V
Emitter – Base Breakdown Voltage ( $I_E = 1.0\ \mu\text{A}$ ) BC846 BC847 BC848	$V_{(BR)EBO}$	6.0 6.0 5.0	– – –	– – –	V
Collector Cutoff Current ( $V_{CB} = 30\text{ V}$ ) ( $V_{CB} = 30\text{ V}$ , $T_A = 150^\circ\text{C}$ )	$I_{CBO}$	– –	– –	15 5.0	nA $\mu\text{A}$

## ON CHARACTERISTICS

DC Current Gain ( $I_C = 10\ \mu\text{A}$ , $V_{CE} = 5.0\text{ V}$ ) BC846B, BC847B BC847C, BC848C ( $I_C = 2.0\text{ mA}$ , $V_{CE} = 5.0\text{ V}$ ) BC846B, BC847B BC847C, BC848C	$h_{FE}$	– – 200 420	150 270 290 520	– – 450 800	–
Collector – Emitter Saturation Voltage ( $I_C = 10\text{ mA}$ , $I_B = 0.5\text{ mA}$ ) ( $I_C = 100\text{ mA}$ , $I_B = 5.0\text{ mA}$ )	$V_{CE(sat)}$	– –	– –	0.25 0.6	V
Base – Emitter Saturation Voltage ( $I_C = 10\text{ mA}$ , $I_B = 0.5\text{ mA}$ ) ( $I_C = 100\text{ mA}$ , $I_B = 5.0\text{ mA}$ )	$V_{BE(sat)}$	– –	0.7 0.9	– –	V
Base – Emitter Voltage ( $I_C = 2.0\text{ mA}$ , $V_{CE} = 5.0\text{ V}$ ) ( $I_C = 10\text{ mA}$ , $V_{CE} = 5.0\text{ V}$ )	$V_{BE(on)}$	580 –	660 –	700 770	mV

## SMALL-SIGNAL CHARACTERISTICS

Current – Gain – Bandwidth Product ( $I_C = 10\text{ mA}$ , $V_{CE} = 5.0\text{ Vdc}$ , $f = 100\text{ MHz}$ )	$f_T$	100	–	–	MHz
Output Capacitance ( $V_{CB} = 10\text{ V}$ , $f = 1.0\text{ MHz}$ )	$C_{obo}$	–	–	4.5	pF
Noise Figure ( $I_C = 0.2\text{ mA}$ , $V_{CE} = 5.0\text{ Vdc}$ , $R_S = 2.0\text{ k}\Omega$ , $f = 1.0\text{ kHz}$ , $BW = 200\text{ Hz}$ )	NF	–	–	10	dB

Product parametric performance is indicated in the Electrical Characteristics for the listed test conditions, unless otherwise noted. Product performance may not be indicated by the Electrical Characteristics if operated under different conditions.

# BC846BDW1, BC847BDW1, BC848CDW1

## TYPICAL CHARACTERISTICS – BC846BDW1

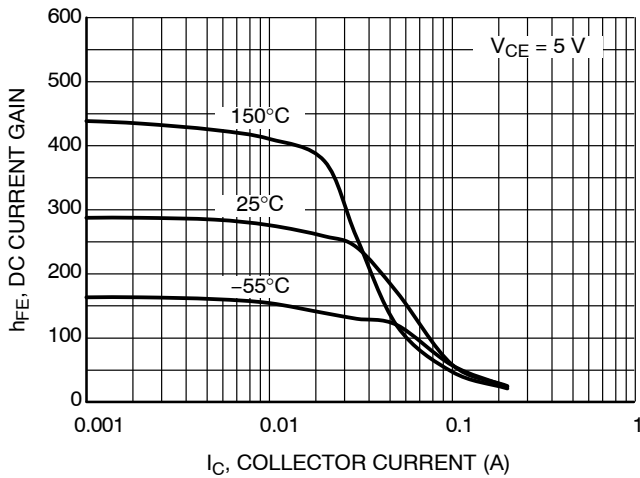

Figure 1. DC Current Gain at  $V_{CE} = 5 V$

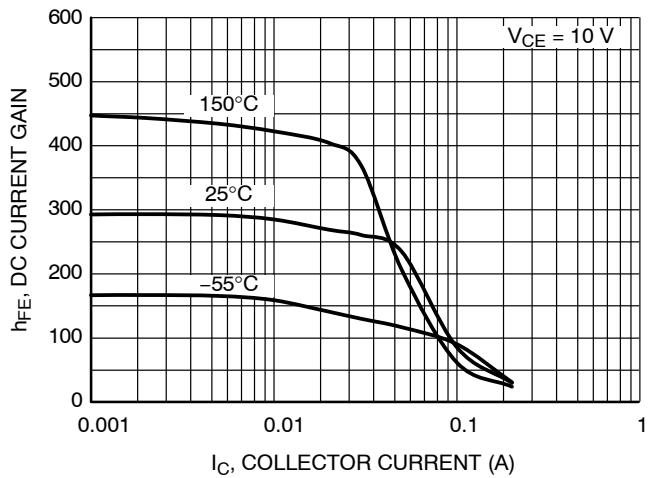

Figure 2. DC Current Gain at  $V_{CE} = 10 V$

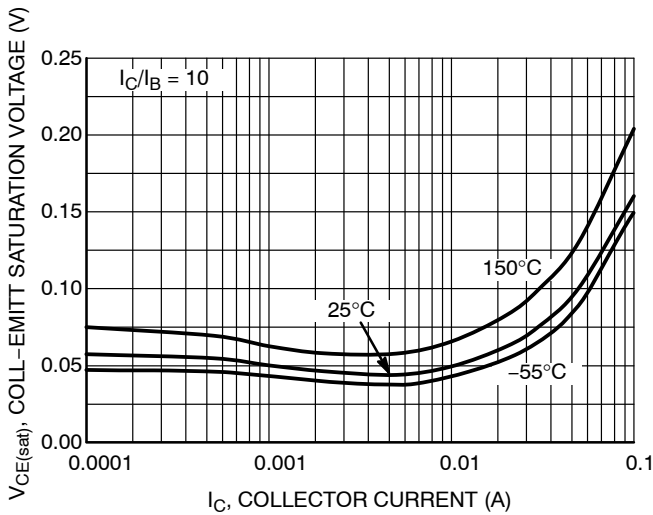

Figure 3.  $V_{CE(sat)}$  at  $I_C/I_B = 10$

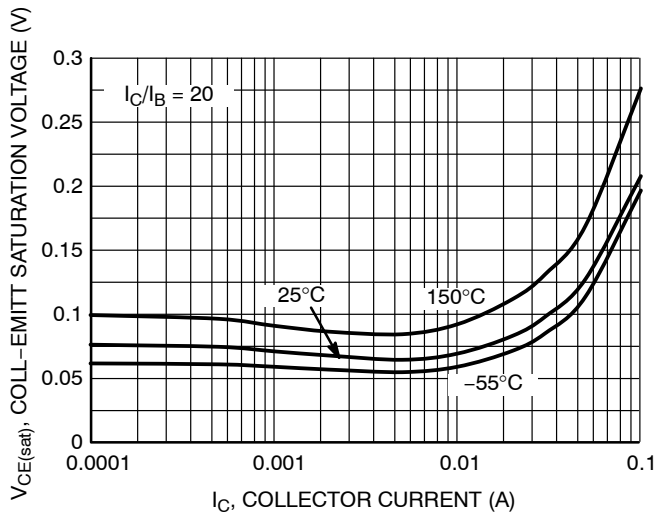

Figure 4.  $V_{CE(sat)}$  at  $I_C/I_B = 20$

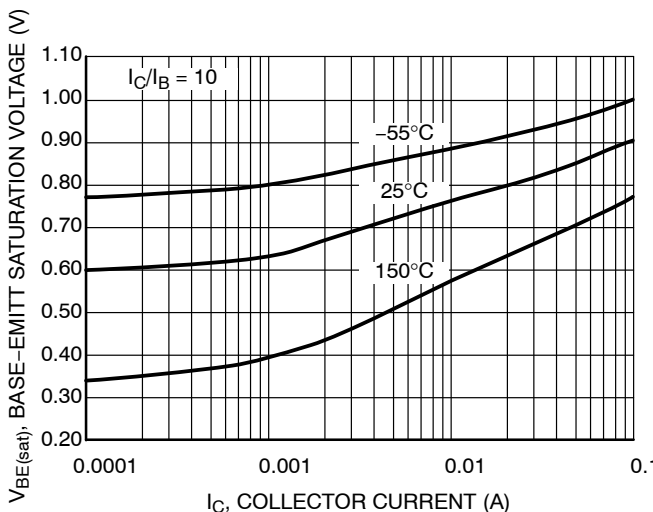

Figure 5.  $V_{BE(sat)}$  at  $I_C/I_B = 10$

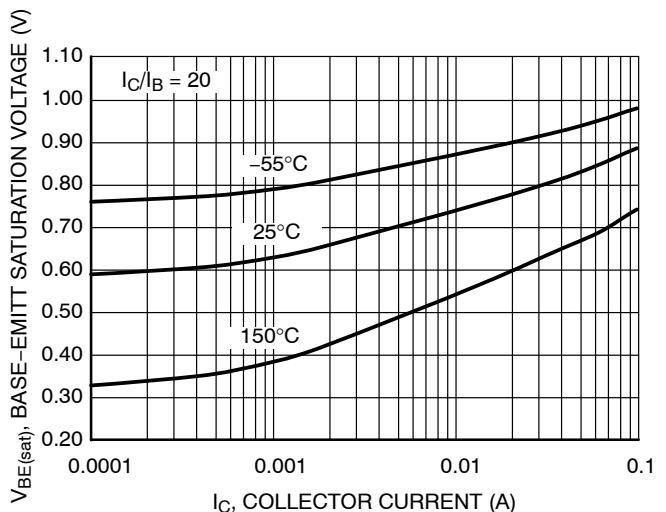

Figure 6.  $V_{BE(sat)}$  at  $I_C/I_B = 20$

# BC846BDW1, BC847BDW1, BC848CDW1

## TYPICAL CHARACTERISTICS – BC846BDW1

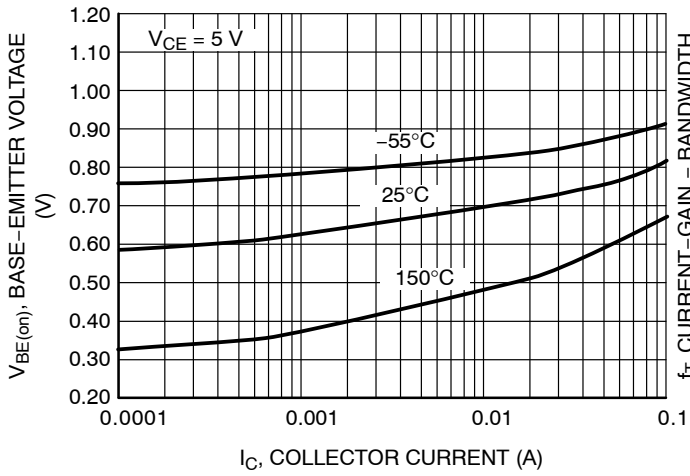

Figure 7.  $V_{BE(on)}$  at  $V_{CE} = 5\text{ V}$

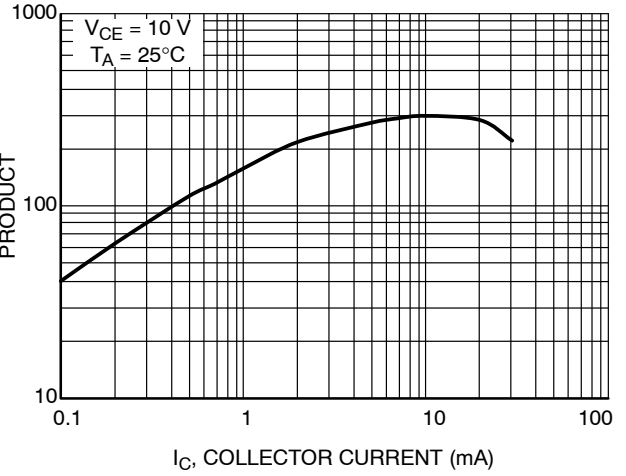

Figure 8. Current - Gain - Bandwidth Product

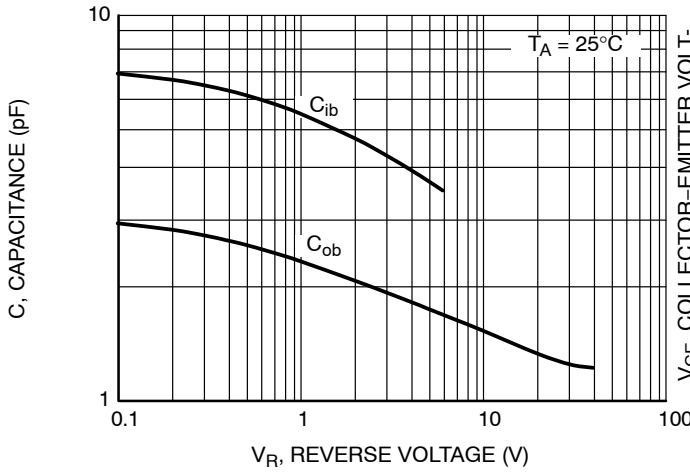

Figure 9. Capacitances

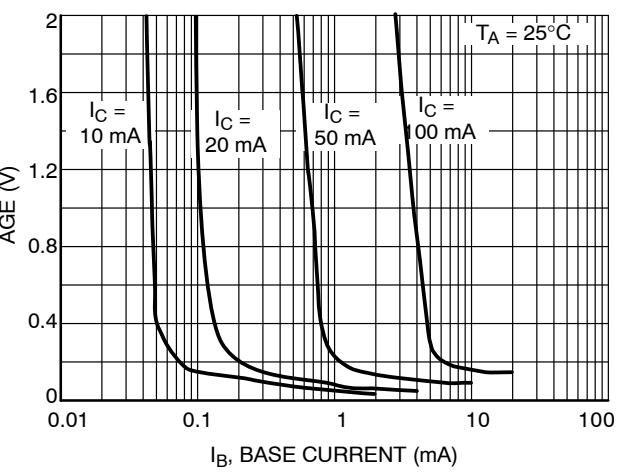

Figure 10. Collector Saturation Region

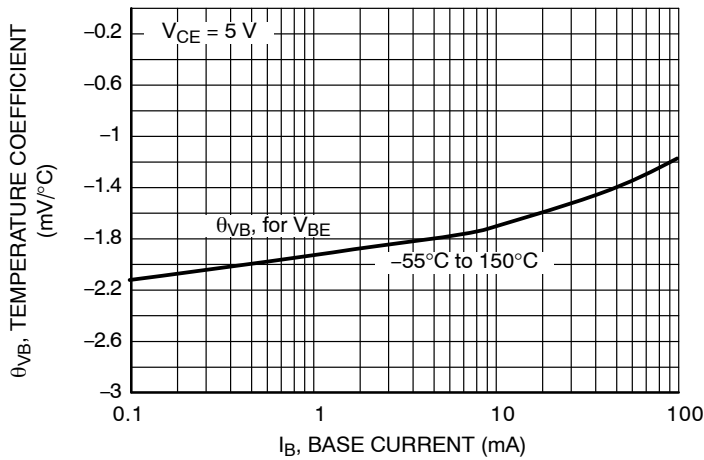

Figure 11. Base-Emitter Temperature Coefficient

# BC846BDW1, BC847BDW1, BC848CDW1

## TYPICAL CHARACTERISTICS – BC847BDW1

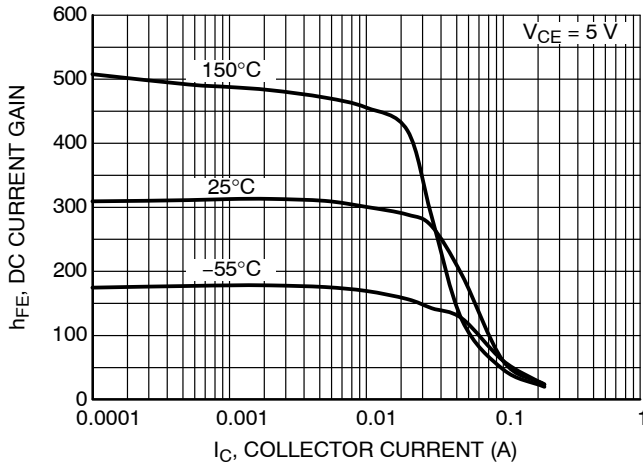

Figure 12. DC Current Gain at  $V_{CE} = 5\text{ V}$

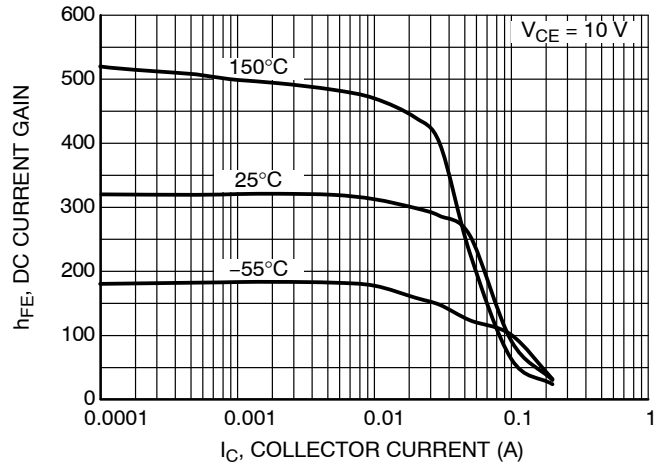

Figure 13. DC Current Gain at  $V_{CE} = 10\text{ V}$

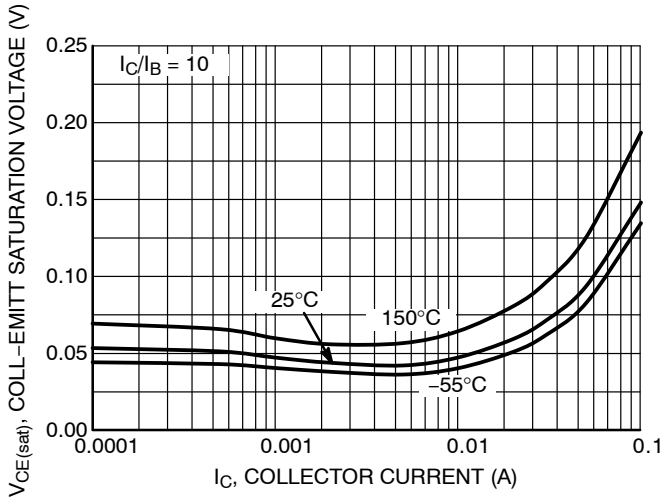

Figure 14.  $V_{CE(sat)}$  at  $I_C/I_B = 10$

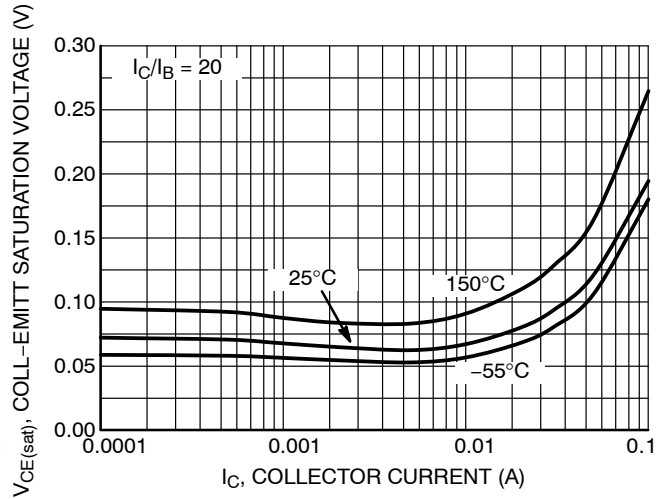

Figure 15.  $V_{CE(sat)}$  at  $I_C/I_B = 20$

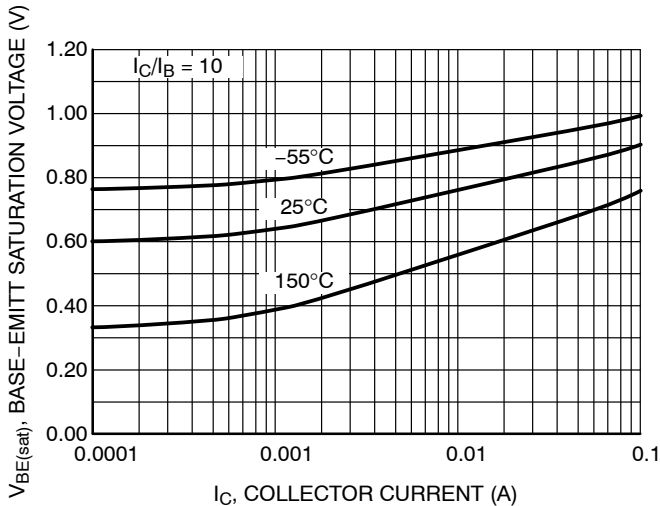

Figure 16.  $V_{BE(sat)}$  at  $I_C/I_B = 10$

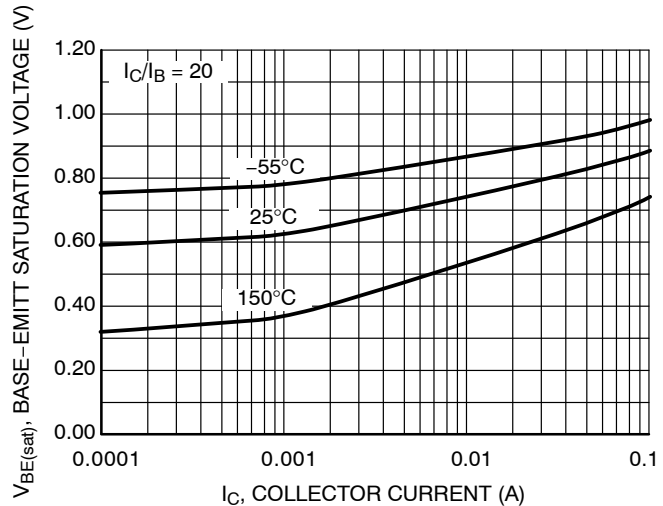

Figure 17.  $V_{BE(sat)}$  at  $I_C/I_B = 20$

# BC846BDW1, BC847BDW1, BC848CDW1

## TYPICAL CHARACTERISTICS – BC847BDW1

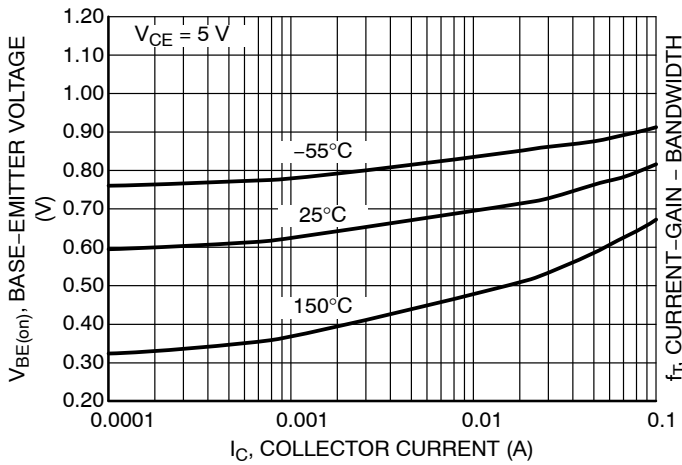

Figure 18.  $V_{BE(on)}$  at  $V_{CE} = 5\text{ V}$

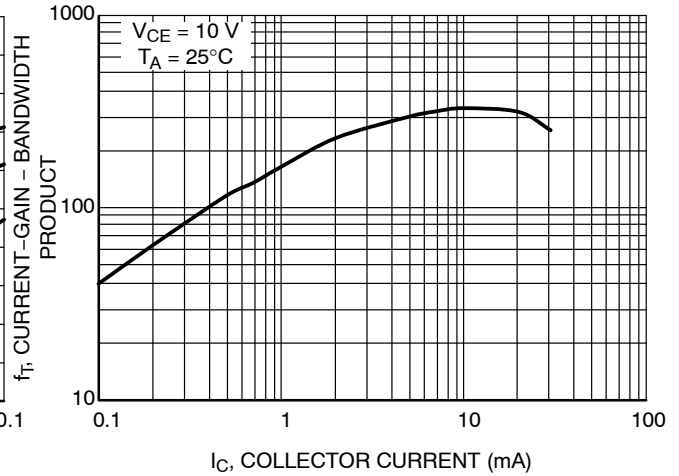

Figure 19. Current - Gain - Bandwidth Product

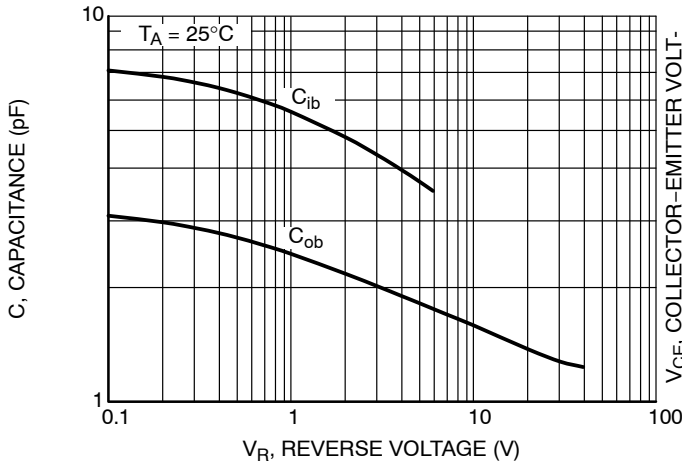

Figure 20. Capacitances

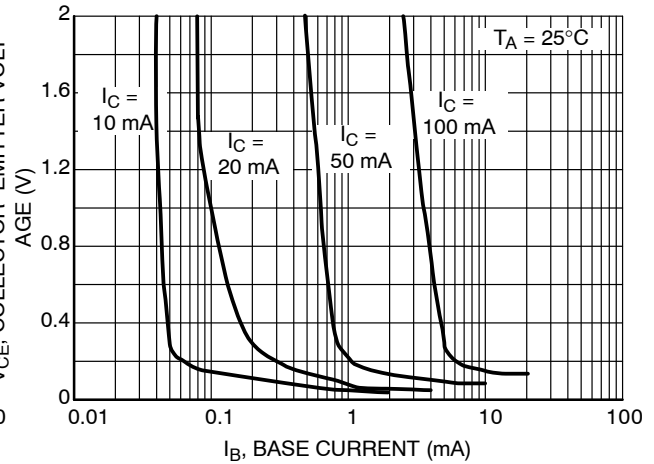

Figure 21. Collector Saturation Region

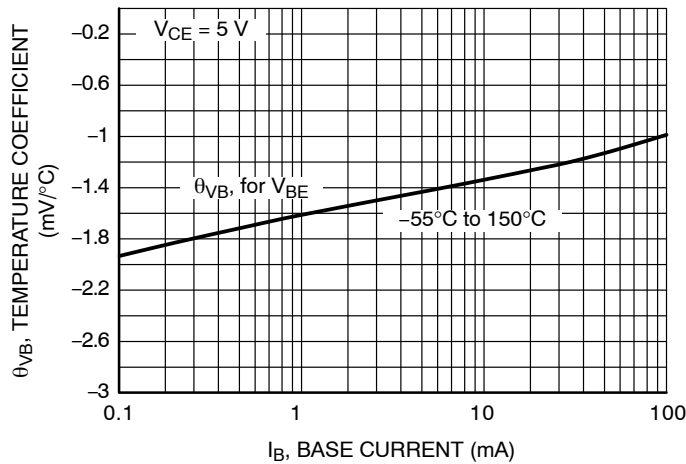

Figure 22. Base-Emitter Temperature Coefficient

# BC846BDW1, BC847BDW1, BC848CDW1

## TYPICAL CHARACTERISTICS – BC848CDW1

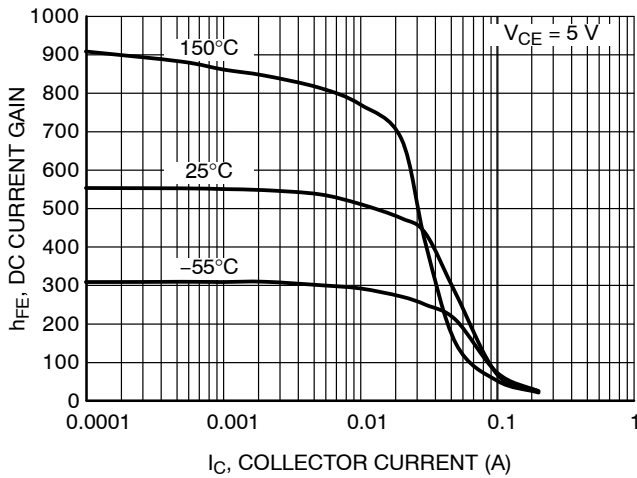

Figure 23. DC Current Gain at  $V_{CE} = 5\text{ V}$

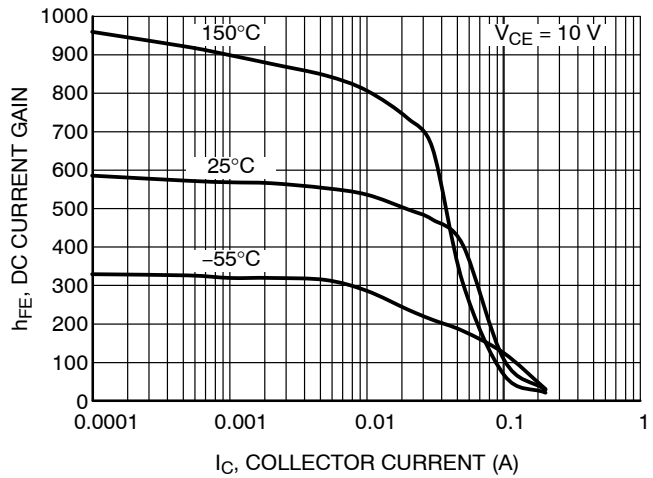

Figure 24. DC Current Gain at  $V_{CE} = 10\text{ V}$

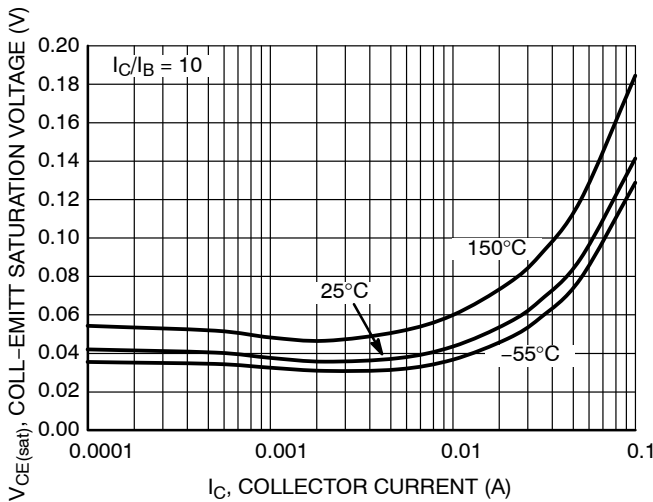

Figure 25.  $V_{CE}$  at  $I_C/I_B = 10$

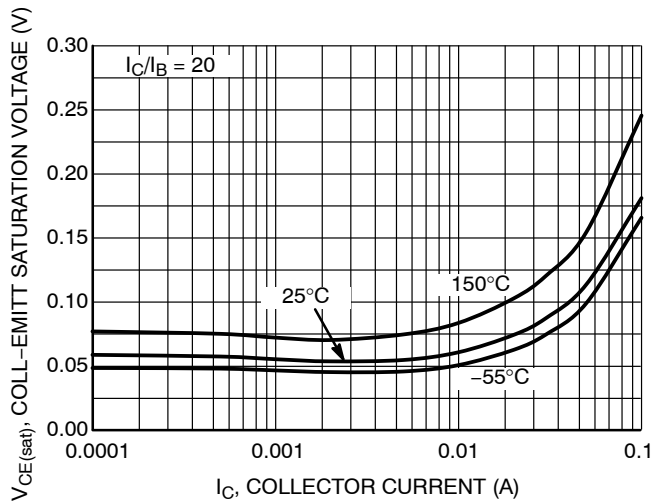

Figure 26.  $V_{CE}$  at  $I_C/I_B = 20$

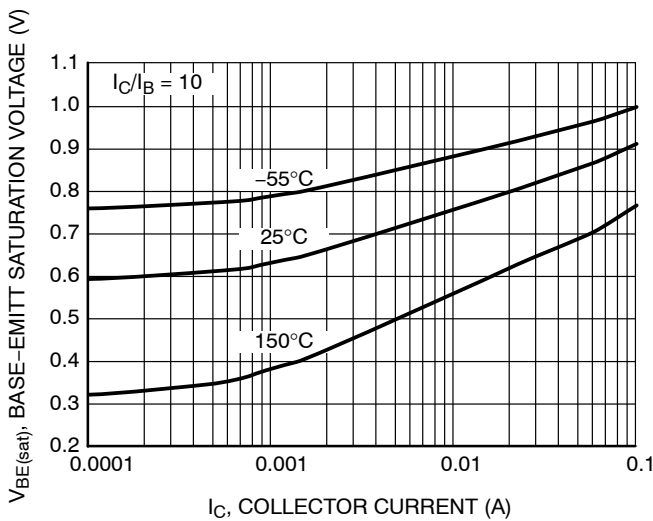

Figure 27.  $V_{BE(sat)}$  at  $I_C/I_B = 10$

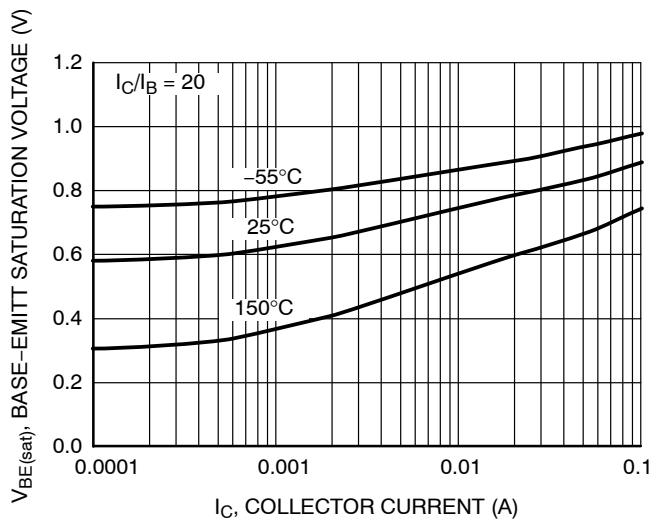

Figure 28.  $V_{BE(sat)}$  at  $I_C/I_B = 20$

# BC846BDW1, BC847BDW1, BC848CDW1

## TYPICAL CHARACTERISTICS – BC848CDW1

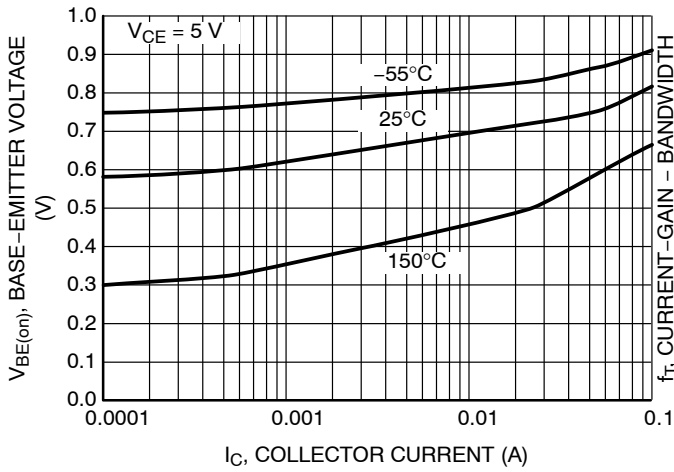

Figure 29.  $V_{BE(on)}$  at  $V_{CE} = 5\text{ V}$

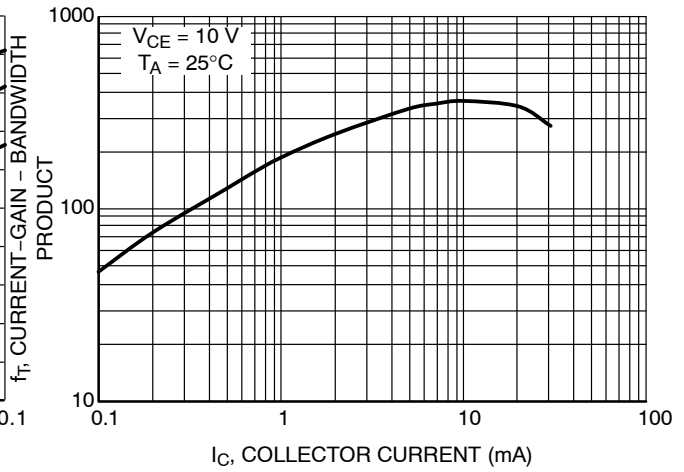

Figure 30. Current - Gain - Bandwidth Product

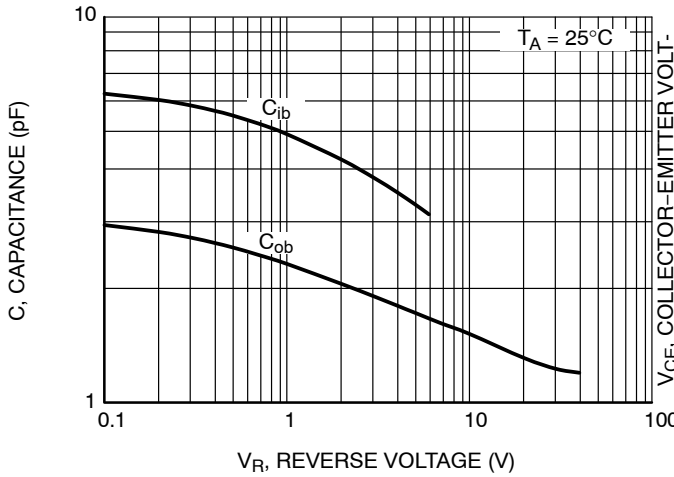

Figure 31. Capacitances

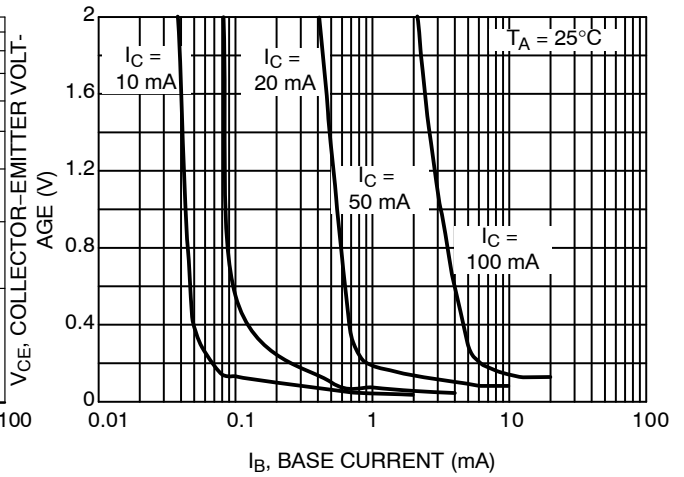

Figure 32. Collector Saturation Region

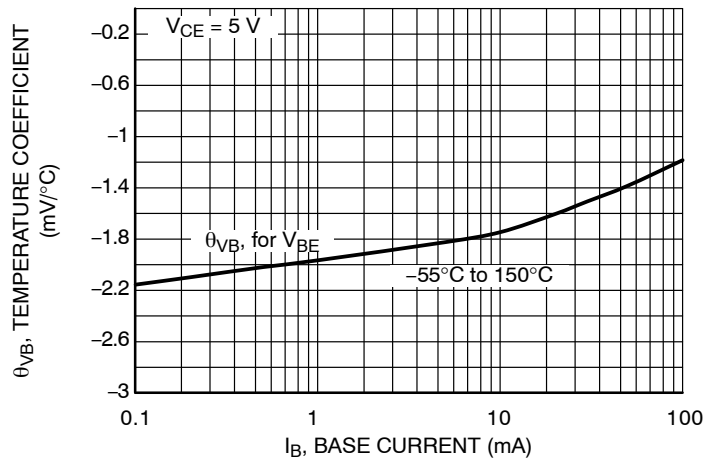

Figure 33. Base-Emitter Temperature Coefficient



# BC846BDW1, BC847BDW1, BC848CDW1

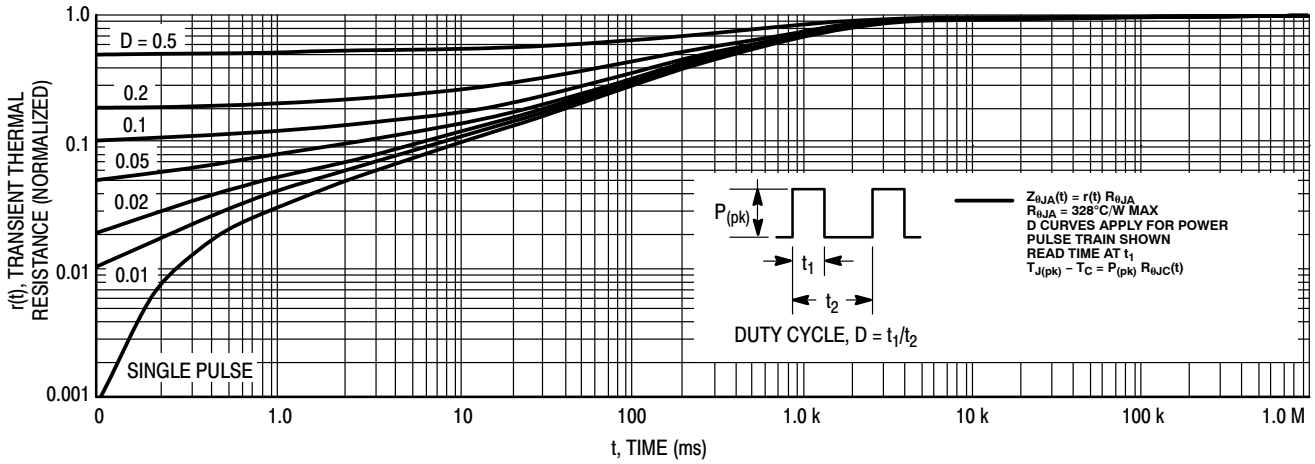

Figure 34. Thermal Response

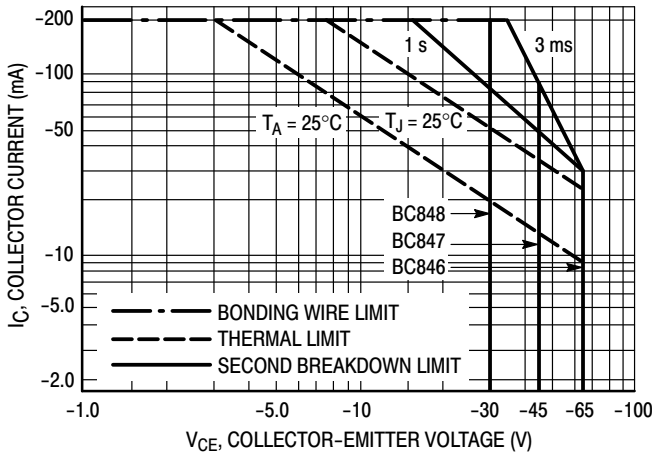

Figure 35. Active Region Safe Operating Area

The safe operating area curves indicate  $I_C$ - $V_{CE}$  limits of the transistor that must be observed for reliable operation. Collector load lines for specific circuits must fall below the limits indicated by the applicable curve.

The data of Figure 35 is based upon  $T_{J(pk)} = 150^\circ\text{C}$ ;  $T_C$  or  $T_A$  is variable depending upon conditions. Pulse curves are valid for duty cycles to 10% provided  $T_{J(pk)} \leq 150^\circ\text{C}$ .  $T_{J(pk)}$  may be calculated from the data in Figure 34. At high case or ambient temperatures, thermal limitations will reduce the power that can be handled to values less than the limitations imposed by the secondary breakdown.

## BC846BDW1, BC847BDW1, BC848CDW1

### ORDERING INFORMATION

Device	Markings	Package	Shipping <sup>†</sup>
BC846BDW1T1G	1B	SOT-363 (Pb-Free)	3,000 / Tape & Reel
SBC846BDW1T1G*	1B	SOT-363 (Pb-Free)	3,000 / Tape & Reel
BC847BDW1T1G	1F	SOT-363 (Pb-Free)	3,000 / Tape & Reel
SBC847BDW1T1G*	1F	SOT-363 (Pb-Free)	3,000 / Tape & Reel
BC847BDW1T3G	1F	SOT-363 (Pb-Free)	10,000 / Tape & Reel
SBC847BDW1T3G*	1F	SOT-363 (Pb-Free)	10,000 / Tape & Reel
NSVBC847BDW1T2G*	1F	SOT-363 (Pb-Free)	3,000 / Tape & Reel
BC847CDW1T1G	1G	SOT-363 (Pb-Free)	3,000 / Tape & Reel
SBC847CDW1T1G*	1G	SOT-363 (Pb-Free)	3,000 / Tape & Reel
BC848CDW1T1G	1L	SOT-363 (Pb-Free)	3,000 / Tape & Reel
NSVBC848CDW1T1G*	1L	SOT-363 (Pb-Free)	3,000 / Tape & Reel

<sup>†</sup>For information on tape and reel specifications, including part orientation and tape sizes, please refer to our Tape and Reel Packaging Specifications Brochure, BRD8011/D.

\*S and NSV Prefixes for Automotive and Other Applications Requiring Unique Site and Control Change Requirements; AEC-Q101 Qualified and PPAP Capable.



1  
SCALE 2:1

SC-88/SC70-6/SOT-363  
CASE 419B-02  
ISSUE Y

DATE 11 DEC 2012

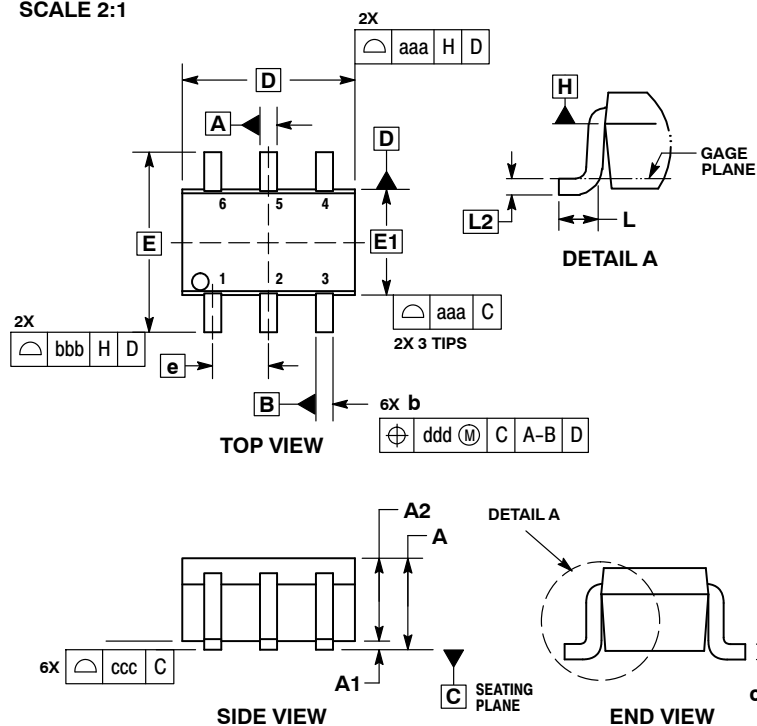

- NOTES:
1. DIMENSIONING AND TOLERANCING PER ASME Y14.5M, 1994.
  2. CONTROLLING DIMENSION: MILLIMETERS.
  3. DIMENSIONS D AND E1 DO NOT INCLUDE MOLD FLASH, PROTRUSIONS, OR GATE BURRS. MOLD FLASH, PROTRUSIONS, OR GATE BURRS SHALL NOT EXCEED 0.20 PER END.
  4. DIMENSIONS D AND E1 AT THE OUTERMOST EXTREMES OF THE PLASTIC BODY AND DATUM H.
  5. DATUMS A AND B ARE DETERMINED AT DATUM H.
  6. DIMENSIONS b AND c APPLY TO THE FLAT SECTION OF THE LEAD BETWEEN 0.08 AND 0.15 FROM THE TIP.
  7. DIMENSION b DOES NOT INCLUDE DAMBAR PROTRUSION. ALLOWABLE DAMBAR PROTRUSION SHALL BE 0.08 TOTAL IN EXCESS OF DIMENSION b AT MAXIMUM MATERIAL CONDITION. THE DAMBAR CANNOT BE LOCATED ON THE LOWER RADIUS OF THE FOOT.

DIM	MILLIMETERS			INCHES		
	MIN	NOM	MAX	MIN	NOM	MAX
A	---	---	1.10	---	---	0.043
A1	0.00	---	0.10	0.000	---	0.004
A2	0.70	0.90	1.00	0.027	0.035	0.039
b	0.15	0.20	0.25	0.006	0.008	0.010
C	0.08	0.15	0.22	0.003	0.006	0.009
D	1.80	2.00	2.20	0.070	0.078	0.086
E	2.00	2.10	2.20	0.078	0.082	0.086
E1	1.15	1.25	1.35	0.045	0.049	0.053
e	0.65 BSC			0.026 BSC		
L	0.26	0.36	0.46	0.010	0.014	0.018
L2	0.15 BSC			0.006 BSC		
aaa	0.15			0.006		
bbb	0.30			0.012		
ccc	0.10			0.004		
ddd	0.10			0.004		

### GENERIC MARKING DIAGRAM\*



- XXX = Specific Device Code
- M = Date Code\*
- = Pb-Free Package

(Note: Microdot may be in either location)

\*Date Code orientation and/or position may vary depending upon manufacturing location.

\*This information is generic. Please refer to device data sheet for actual part marking. Pb-Free indicator, "G" or microdot "▪", may or may not be present. Some products may not follow the Generic Marking.

### RECOMMENDED SOLDERING FOOTPRINT\*

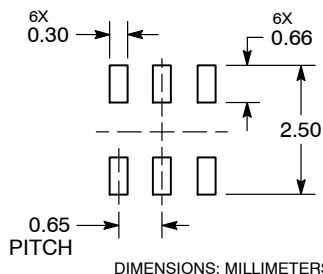

\*For additional information on our Pb-Free strategy and soldering details, please download the ON Semiconductor Soldering and Mounting Techniques Reference Manual, SOLDERRM/D.

### STYLES ON PAGE 2

DOCUMENT NUMBER:	98ASB42985B	Electronic versions are uncontrolled except when accessed directly from the Document Repository. Printed versions are uncontrolled except when stamped "CONTROLLED COPY" in red.
DESCRIPTION:	SC-88/SC70-6/SOT-363	PAGE 1 OF 2

ON Semiconductor and ON are trademarks of Semiconductor Components Industries, LLC dba ON Semiconductor or its subsidiaries in the United States and/or other countries. ON Semiconductor reserves the right to make changes without further notice to any products herein. ON Semiconductor makes no warranty, representation or guarantee regarding the suitability of its products for any particular purpose, nor does ON Semiconductor assume any liability arising out of the application or use of any product or circuit, and specifically disclaims any and all liability, including without limitation special, consequential or incidental damages. ON Semiconductor does not convey any license under its patent rights nor the rights of others.

**SC-88/SC70-6/SOT-363**  
**CASE 419B-02**  
**ISSUE Y**

DATE 11 DEC 2012

<b>STYLE 1:</b> PIN 1. EMITTER 2 2. BASE 2 3. COLLECTOR 1 4. EMITTER 1 5. BASE 1 6. COLLECTOR 2	<b>STYLE 2:</b> CANCELLED	<b>STYLE 3:</b> CANCELLED	<b>STYLE 4:</b> PIN 1. CATHODE 2. CATHODE 3. COLLECTOR 4. EMITTER 5. BASE 6. ANODE	<b>STYLE 5:</b> PIN 1. ANODE 2. ANODE 3. COLLECTOR 4. EMITTER 5. BASE 6. CATHODE	<b>STYLE 6:</b> PIN 1. ANODE 2 2. N/C 3. CATHODE 1 4. ANODE 1 5. N/C 6. CATHODE 2
<b>STYLE 7:</b> PIN 1. SOURCE 2 2. DRAIN 2 3. GATE 1 4. SOURCE 1 5. DRAIN 1 6. GATE 2	<b>STYLE 8:</b> CANCELLED	<b>STYLE 9:</b> PIN 1. EMITTER 2 2. EMITTER 1 3. COLLECTOR 1 4. BASE 1 5. BASE 2 6. COLLECTOR 2	<b>STYLE 10:</b> PIN 1. SOURCE 2 2. SOURCE 1 3. GATE 1 4. DRAIN 1 5. DRAIN 2 6. GATE 2	<b>STYLE 11:</b> PIN 1. CATHODE 2 2. CATHODE 2 3. ANODE 1 4. CATHODE 1 5. CATHODE 1 6. ANODE 2	<b>STYLE 12:</b> PIN 1. ANODE 2 2. ANODE 2 3. CATHODE 1 4. ANODE 1 5. ANODE 1 6. CATHODE 2
<b>STYLE 13:</b> PIN 1. ANODE 2. N/C 3. COLLECTOR 4. EMITTER 5. BASE 6. CATHODE	<b>STYLE 14:</b> PIN 1. VREF 2. GND 3. GND 4. IOUT 5. VEN 6. VCC	<b>STYLE 15:</b> PIN 1. ANODE 1 2. ANODE 2 3. ANODE 3 4. CATHODE 3 5. CATHODE 2 6. CATHODE 1	<b>STYLE 16:</b> PIN 1. BASE 1 2. EMITTER 2 3. COLLECTOR 2 4. BASE 2 5. EMITTER 1 6. COLLECTOR 1	<b>STYLE 17:</b> PIN 1. BASE 1 2. EMITTER 1 3. COLLECTOR 2 4. BASE 2 5. EMITTER 2 6. COLLECTOR 1	<b>STYLE 18:</b> PIN 1. VIN1 2. VCC 3. VOUT2 4. VIN2 5. GND 6. VOUT1
<b>STYLE 19:</b> PIN 1. IOUT 2. GND 3. GND 4. V CC 5. V EN 6. V REF	<b>STYLE 20:</b> PIN 1. COLLECTOR 2. COLLECTOR 3. BASE 4. EMITTER 5. COLLECTOR 6. COLLECTOR	<b>STYLE 21:</b> PIN 1. ANODE 1 2. N/C 3. ANODE 2 4. CATHODE 2 5. N/C 6. CATHODE 1	<b>STYLE 22:</b> PIN 1. D1 (i) 2. GND 3. D2 (i) 4. D2 (c) 5. VBUS 6. D1 (c)	<b>STYLE 23:</b> PIN 1. Vn 2. CH1 3. Vp 4. N/C 5. CH2 6. N/C	<b>STYLE 24:</b> PIN 1. CATHODE 2. ANODE 3. CATHODE 4. CATHODE 5. CATHODE 6. CATHODE
<b>STYLE 25:</b> PIN 1. BASE 1 2. CATHODE 3. COLLECTOR 2 4. BASE 2 5. EMITTER 6. COLLECTOR 1	<b>STYLE 26:</b> PIN 1. SOURCE 1 2. GATE 1 3. DRAIN 2 4. SOURCE 2 5. GATE 2 6. DRAIN 1	<b>STYLE 27:</b> PIN 1. BASE 2 2. BASE 1 3. COLLECTOR 1 4. EMITTER 1 5. EMITTER 2 6. COLLECTOR 2	<b>STYLE 28:</b> PIN 1. DRAIN 2. DRAIN 3. GATE 4. SOURCE 5. DRAIN 6. DRAIN	<b>STYLE 29:</b> PIN 1. ANODE 2. ANODE 3. COLLECTOR 4. EMITTER 5. BASE/ANODE 6. CATHODE	<b>STYLE 30:</b> PIN 1. SOURCE 1 2. DRAIN 2 3. DRAIN 2 4. SOURCE 2 5. GATE 1 6. DRAIN 1

Note: Please refer to datasheet for style callout. If style type is not called out in the datasheet refer to the device datasheet pinout or pin assignment.

<b>DOCUMENT NUMBER:</b>	<b>98ASB42985B</b>	Electronic versions are uncontrolled except when accessed directly from the Document Repository. Printed versions are uncontrolled except when stamped "CONTROLLED COPY" in red.
<b>DESCRIPTION:</b>	<b>SC-88/SC70-6/SOT-363</b>	<b>PAGE 2 OF 2</b>

ON Semiconductor and  are trademarks of Semiconductor Components Industries, LLC dba ON Semiconductor or its subsidiaries in the United States and/or other countries. ON Semiconductor reserves the right to make changes without further notice to any products herein. ON Semiconductor makes no warranty, representation or guarantee regarding the suitability of its products for any particular purpose, nor does ON Semiconductor assume any liability arising out of the application or use of any product or circuit, and specifically disclaims any and all liability, including without limitation special, consequential or incidental damages. ON Semiconductor does not convey any license under its patent rights nor the rights of others.

**onsemi**, **Onsemi**, and other names, marks, and brands are registered and/or common law trademarks of Semiconductor Components Industries, LLC dba "**onsemi**" or its affiliates and/or subsidiaries in the United States and/or other countries. **onsemi** owns the rights to a number of patents, trademarks, copyrights, trade secrets, and other intellectual property. A listing of **onsemi**'s product/patent coverage may be accessed at [www.onsemi.com/site/pdf/Patent-Marking.pdf](http://www.onsemi.com/site/pdf/Patent-Marking.pdf). **onsemi** reserves the right to make changes at any time to any products or information herein, without notice. The information herein is provided "as-is" and **onsemi** makes no warranty, representation or guarantee regarding the accuracy of the information, product features, availability, functionality, or suitability of its products for any particular purpose, nor does **onsemi** assume any liability arising out of the application or use of any product or circuit, and specifically disclaims any and all liability, including without limitation special, consequential or incidental damages. Buyer is responsible for its products and applications using **onsemi** products, including compliance with all laws, regulations and safety requirements or standards, regardless of any support or applications information provided by **onsemi**. "Typical" parameters which may be provided in **onsemi** data sheets and/or specifications can and do vary in different applications and actual performance may vary over time. All operating parameters, including "Typicals" must be validated for each customer application by customer's technical experts. **onsemi** does not convey any license under any of its intellectual property rights nor the rights of others. **onsemi** products are not designed, intended, or authorized for use as a critical component in life support systems or any FDA Class 3 medical devices or medical devices with a same or similar classification in a foreign jurisdiction or any devices intended for implantation in the human body. Should Buyer purchase or use **onsemi** products for any such unintended or unauthorized application, Buyer shall indemnify and hold **onsemi** and its officers, employees, subsidiaries, affiliates, and distributors harmless against all claims, costs, damages, and expenses, and reasonable attorney fees arising out of, directly or indirectly, any claim of personal injury or death associated with such unintended or unauthorized use, even if such claim alleges that **onsemi** was negligent regarding the design or manufacture of the part. **onsemi** is an Equal Opportunity/Affirmative Action Employer. This literature is subject to all applicable copyright laws and is not for resale in any manner.

## PUBLICATION ORDERING INFORMATION

### LITERATURE FULFILLMENT:

Email Requests to: [orderlit@onsemi.com](mailto:orderlit@onsemi.com)

**onsemi Website:** [www.onsemi.com](http://www.onsemi.com)

### TECHNICAL SUPPORT

**North American Technical Support:**

Voice Mail: 1 800-282-9855 Toll Free USA/Canada

Phone: 011 421 33 790 2910

**Europe, Middle East and Africa Technical Support:**

Phone: 00421 33 790 2910

For additional information, please contact your local Sales Representative