

承 认 书

SPECIFICATION FOR APPROVAL

客户名称: Customer _____

货 名: Description HC-49S 石英晶体谐振器

客户料号: Part No _____

物料编号: Code No 49SAC22118202040

频 率: Frequency 22.1184MHZ

日 期: Date 2023-04-14

备 注: RoHS compliance with Directive (EU) 2015/863

| 制作(Prepare by) | 检查(Check by) | 批准 (Approve by) |
|----------------|--------------|-----------------|
| 江丹娜 | 甘瑛 | 张刚 |

| | |
|-----------------------------|--|
| 客户批准 Approve by customer | |
| 批准日期 Approval date | |

Add: 广东省深圳市华发北路桑达工业区桑达雅苑 7P

7 P Sangda Yayuan Huafa North Road, Futian District, Shenzhen, Guangdong

Tel: 86-755-83048260

86-755-83048290

Fax: 86-755-83048280

1、 Specifications

| | | |
|----|--------------------------------------|-------------------|
| 1 | 规格型号 Holder Type | HC-49S |
| 2 | 标称频率 Nominal Frequency | 22.1184MHz |
| 3 | 振动模式 Mode of Oscillation | 基频 |
| 4 | 调整频差 Frequency Tolerance at 25°C | ±20ppm |
| 5 | 温度频差 Temperature Frequency Stability | ±30ppm |
| 6 | 工作温度 Operating Temperature Range | -40~85°C |
| 7 | 贮存温度 Storage Temperature Range | -40~90°C |
| 8 | 负载电容 Load Capacitance | 20pF |
| 9 | 静电容 Shunt capacitance | ≤7 pf |
| 10 | 等效电阻 Equivalent Series Resistance | 30 Ω Max |
| 11 | 激励功率 Drive Level | 50uW |
| 12 | 绝缘阻抗 Insulation Resistance | 500MΩ min./DC100V |

2、 Frequency stability over temperature range (AT cut)

| Temperature Range | Frequency Stability | | | | | | | |
|-------------------|---------------------|-------|---------|--------|--------|--------|--------|--------|
| | ±3PPM | ±5PPM | ±7.5PPM | ±10PPM | ±20PPM | ±30PPM | ±50PPM | ±70PPM |
| 0°C~+50°C | ☆ | ☆ | ☆ | ☆ | ☆ | ☆ | ☆ | ☆ |
| -10°C~+60°C | | | ☆ | ☆ | ☆ | ☆ | ☆ | ☆ |
| -20°C~+70°C | | | | ☆ | ☆ | ☆ | ☆ | ☆ |
| -30°C~+70°C | | | | | ☆ | ☆ | ☆ | ☆ |
| -40°C~+85°C | | | | | | ☆ | ☆ | ☆ |
| -40°C~+125°C | | | | | | ☆ | ☆ | ☆ |

3、Dimensions (unit:mm)

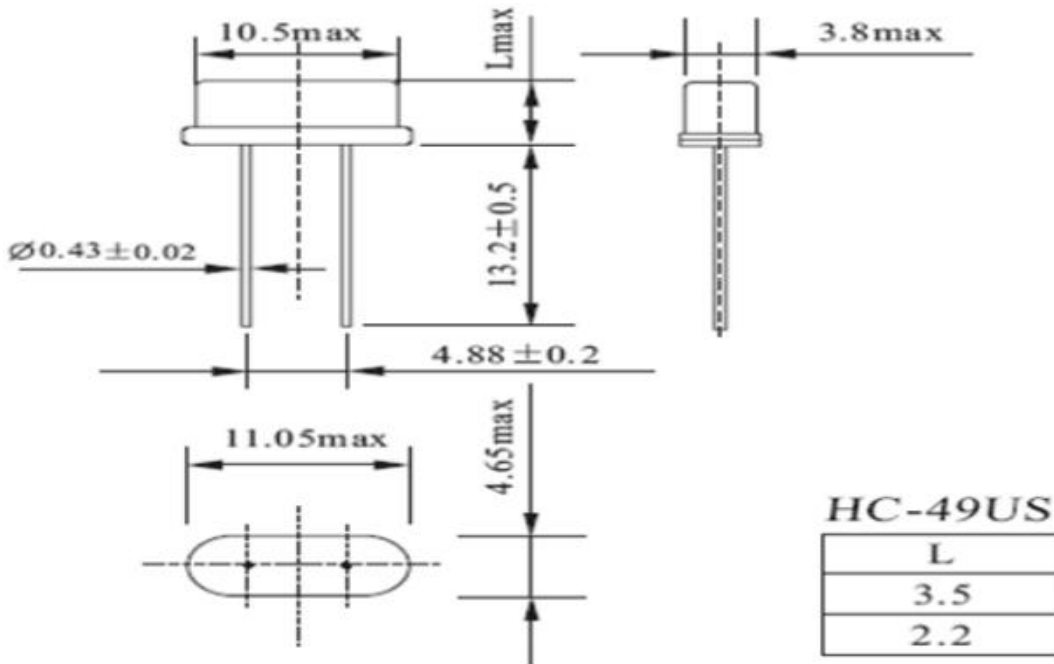

4、 Recommended Reflow profile

Condition:

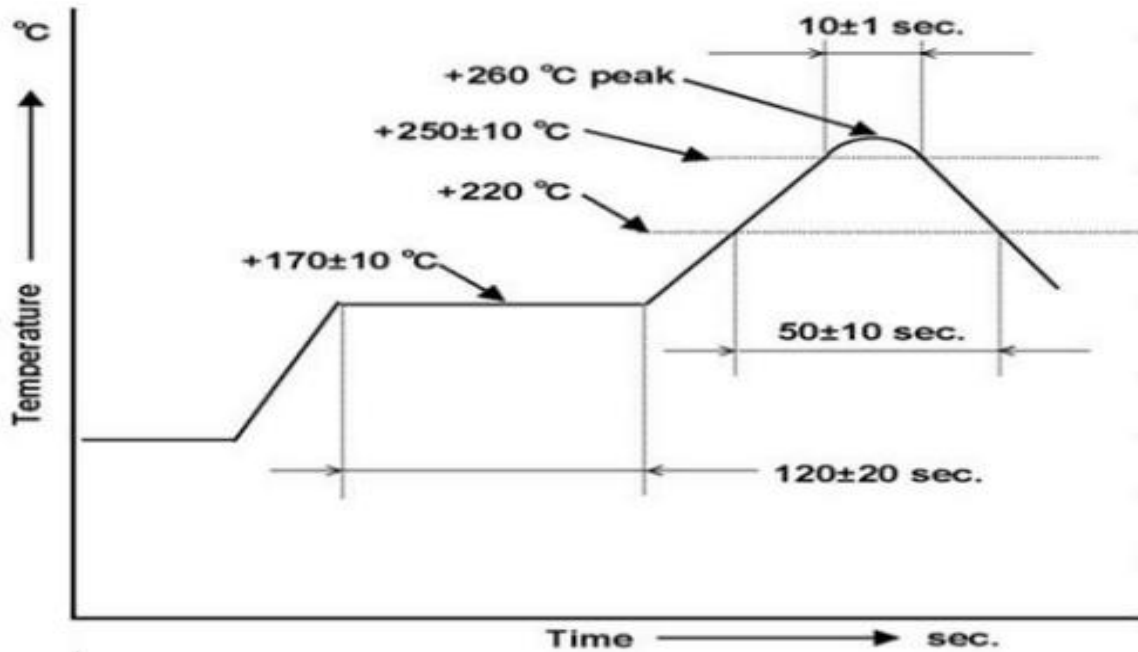

5、Reliability specifications

| NO | Item | Condition | Standard |
|----|------------------------------|--|--|
| 1. | Drop Test | Free drop from 50cm height on a hard wooden board for 3 times. (Board is thickness more than 30 mm.) | Frequency change: ≤5ppm Rr as specification |
| 2. | Mechanical Shock | Half sine wave, 1000G, 0.5mS, three times for all 3 directions | Frequency change: ≤5ppm Rr as specification |
| 3. | Vibration | Frequency range:10~55hz Amplitude:1.52mm Sweep time:1mintutes perpendicular axes each test time:2Hrs | Frequency change: ≤5ppm Rr as specification |
| 4. | Solderability | Temperature:245℃±5℃ Immersing depth:0.5mm minimum Immersion time:5±1sec. Flux:Rosin resin methyl alcohol solvent(1:4) | 90% exhibit tin ok |
| 5. | Resistance to soldering heat | Test temperature:260℃±5℃ Test time :10±1sec. | Frequency change: ≤10ppm Rr as specification |
| 6. | High Temp & Humidity | 85±3℃ & RH85%, 500±12 hours | Frequency change: ≤10ppm Rr as specification |
| 7. | Low temperature storage | -40±3℃, 500±12 hours | Frequency change: ≤10ppm Rr as specification |
| 8. | High temperature storage | +85±3℃, 500±12 hours | Frequency change: ≤10ppm Rr as specification |
| 9. | Temperature cycling | -40±3℃/10min~+85±3℃/10min, 100cycles | Frequency change: ≤10ppm Rr as specification |

6、Packaging standard

Dimension of Inside Package

内包装尺寸图

Dimensions of outside Package

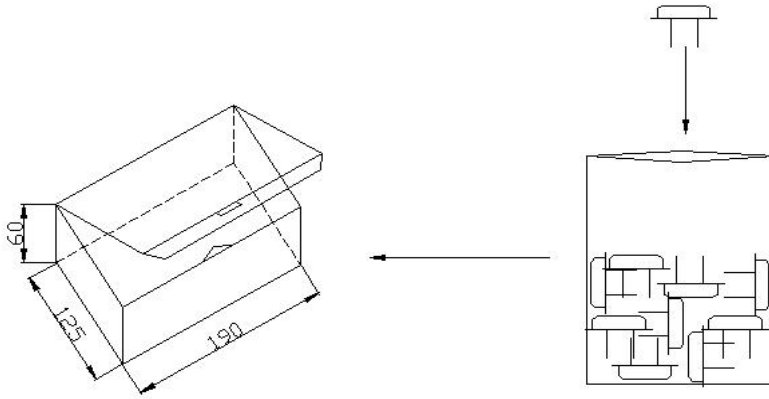

7-1. MARKING

- (1) Marking Labels are affixed to reel, inner carton and outer carton.
- (2) Each label contains the following information.
 - (a) Manufacture's name or symbol
 - (b) Parts name or type
 - (c) Frequency
 - (d) Quantity
 - (e) Reel number
 - (f) Manufacturer's code (EIAJ code)

7-2. QUANTITY

200pcs/bag

7-3. STORAGE ENVIRONMENT

- ✧ Storage the reel at normal temperature and humidity
- ✧ Open the packing just before using
- ✧ Do not expose the sun
- ✧ Do not storage with some erosive chemicals
- ✧ Nothing is allowed to put on the reel or carton to prevent mechanical damage

7-4. HANDLING

- ✧ Handle with care to prevent the damage of tape, reel and products.