

Features

- Advanced Trench Process Technology
- Low RDS(ON) to Minimize Conduction Losses
- Low Qg and Capacitance to Minimize Driver Losses
- Superior thermal resistance
- Excellent Gate Charge x RDS(ON) Product (FOM)
- Fully Characterized Capacitance and Avalanche SOA
- Pb-free lead plating; RoHS Compliant

Applications

- Power Management in Desktop Computer or DC/DC Converters.
- Isolated DC/DC Converters in Telecom and Industrial.



Product Summary

V_{DS}	100	V
$R_{DS(on),Max}@V_{GS}=10V$	6.6	mΩ
I_D	90	A

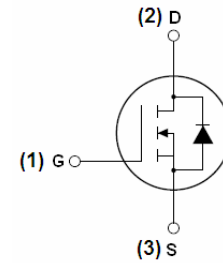
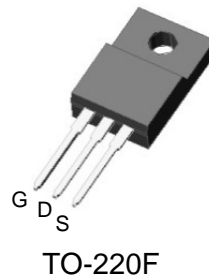

Absolute Maximum Ratings ($T_J = 25^\circ\text{C}$ unless otherwise noted)

Symbol	Parameter		Value	Unit
V_{DS}	Drain-Source Voltage		100	V
V_{GS}	Gate-Source Voltage		± 20	V
I_D	Drain Current-Continuous	$T_C = 25^\circ\text{C}$	90	A
I_D		$T_C = 100^\circ\text{C}$	40	A
I_{DM}	Drain Current-Pulsed ^{Note A}	$T_C = 25^\circ\text{C}$	360	A
I_{AS}	Non-repetitive Avalanche Current ^{Note C, E}		24	A
E_{AS}	Single Pulse Drain-to-Source Avalanche Energy ^{Note C, D}		144	mJ
P_{tot}	Maximum Power Dissipation	$T_C = 25^\circ\text{C}$	50	W
T_J, T_{STG}	Operating and Storage Temperature Range		-55 to +150	$^\circ\text{C}$

Thermal Resistance Ratings

Symbol	Parameter	Conditions	Min.	Typ.	Max.	Unit
$R_{\theta JA}$	Junction-to-Ambient ^{Note B}	Steady State	-	-	40	$^\circ\text{C}/\text{W}$
$R_{\theta JS}$	Junction-to-Soldering Point	Steady State	-	-	3	$^\circ\text{C}/\text{W}$

Notes:

- Repetitive rating, pulse width limited by junction temperature $T_{Jmax} = +150^\circ\text{C}$. Ratings are based on low frequency and duty cycles to keep initial $T_J = +25^\circ\text{C}$.
- $R_{\theta JA}$ is the sum of the junction-to-case and case-to-ambient thermal resistance where the case thermal reference is defined as the solder mounting surface of the drain pins. $R_{\theta JS}$ is guaranteed by design while $R_{\theta CA}$ is determined by the user's board design. $R_{\theta JA}$ shown below for single device operation on FR-4 in still air.
- Limited by T_{Jmax} , starting $T_J = +25^\circ\text{C}$, $L = 0.5\text{mH}$, $R_g = 50\Omega$, $V_{GS} = 10V$.
- I_{AS} and E_{AS} ratings are based on low frequency and duty cycles to keep $T_J = +25^\circ\text{C}$.
- Guaranteed by design. Not subject to product testing.
- Repetitive Avalanche Current Starting $T_J = +25^\circ\text{C}$, $L = 0.5\text{mH}$, $I_{AS} = 24A$, $V_{GS} = 10V$, $V_{DD} = 100V$

Electrical Characteristics (T_J=25°C unless otherwise noted)
STATIC CHARACTERISTICS

Symbol	Parameter	Conditions	Min.	Typ.	Max.	Unit
V _{(BR)DSS}	Drain-Source Breakdown Voltage	V _{GS} = 0V, I _{DS} = 10mA	100	-	-	V
I _{DSS}	Zero Gate Voltage Drain Current	V _{DS} = 80V, V _{GS} = 0V	-	-	1	μA
		V _{DS} = 80V, V _{GS} = 0V, T _J = 125°C	-	-	100	μA
I _{GSS}	Gate-Body Leakage	V _{GS} = ±20V, V _{DS} = 0V	-	-	±100	nA

STATIC CHARACTERISTICS

Symbol	Parameter	Conditions	Min.	Typ.	Max.	Unit
V _{GS(TH)}	Gate Threshold Voltage	V _{DS} = V _{GS} , I _{DS} = 250μA	1.0	-	2.5	V
R _{DS(ON)}	Drain-Source On-State Resistance ^{Note A}	V _{GS} = 10V, I _{DS} = 20A	-	-	6.6	mΩ
R _{DS(ON)}	Drain-Source On-State Resistance ^{Note A}	V _{GS} = 4.5V, I _{DS} = 15A	-	-	8	mΩ
R _g	Gate Resistance ^{Note E}	V _{GS} = 0V, V _{DS} = 0V, f = 1MHz	-	0.7	-	Ω
g _{fs}	Forward Transconductance	V _{DS} = 5V, I _{DS} = 15A	-	60	-	S

DYNAMIC CHARACTERISTICS ^{Note E}

Symbol	Parameter	Conditions	Min.	Typ.	Max.	Unit
C _{iss}	Input Capacitance	V _{DS} = 50V, V _{GS} = 0V, f = 1MHz	-	2551	-	pF
C _{oss}	Output Capacitance	V _{DS} = 50V, V _{GS} = 0V, f = 1MHz	-	495	-	pF
C _{rss}	Reverse Transfer Capacitance	V _{DS} = 50V, V _{GS} = 0V, f = 1MHz	-	34	-	pF
T _{d(on)}	Turn-On Delay Time	V _{DS} = 50V, V _{GS} = 10V, I _{DS} = 20A, R _{GEN} = 3.3Ω	-	19.6	-	ns
t _r	Rise Time	V _{DS} = 50V, V _{GS} = 10V, I _{DS} = 20A, R _{GEN} = 3.3Ω	-	20.8	-	ns
T _{d(off)}	Turn-Off Delay Time	V _{DS} = 50V, V _{GS} = 10V, I _{DS} = 20A, R _{GEN} = 3.3Ω	-	18.8	-	ns
t _f	Fall Time	V _{DS} = 50V, V _{GS} = 10V, I _{DS} = 20A, R _{GEN} = 3.3Ω	-	4.8	-	ns

GATE CHARGE CHARACTERISTICS ^{Note E}

Symbol	Parameter	Conditions	Min.	Typ.	Max.	Unit
Q _{gs}	Gate to Source Gate Charge	V _{DD} = 50V, I _D = 30A, V _{GS} = 0 to 10V	-	9.7	-	nC
Q _{g(th)}	Gate charge at threshold	V _{DD} = 50V, I _D = 30A, V _{GS} = 0 to 10V	-	5.3	-	nC
Q _{gd}	Gate to Drain Charge	V _{DD} = 50V, I _D = 30A, V _{GS} = 0 to 10V	-	16.9	-	nC
Q _{sw}	Switching charge	V _{DD} = 50V, I _D = 30A, V _{GS} = 0 to 10V	-	21.3	-	nC
Q _g	Gate charge total	V _{DD} = 50V, I _D = 30A, V _{GS} = 0 to 10V	-	56.1	-	nC
Q _g	Gate charge total	V _{DD} = 50V, I _D = 30A, V _{GS} = 0 to 4.5V	-	30.1	-	nC
V _{plateau}	Gate plateau voltage	V _{DD} = 50V, I _D = 30A, V _{GS} = 0 to 10V	-	3.5	-	V
Q _{g(sync)}	Gate charge total, sync. FET (Q _g - Q _{gd})	V _{DS} = 0.1V, V _{GS} = 0 to 10V	-	39.2	-	nC

REVERSE DIODE

Symbol	Parameter	Conditions	Min.	Typ.	Max.	Unit
I _S	Diode continuous forward current	T _C = 25°C	-	-	90	A
I _{SM}	Diode pulse current	T _C = 25°C, 100μs	-	-	360	A
V _{SD}	Diode Forward Voltage ^{Note A}	V _{GS} = 0V, I _F = 20A	-	-	1.2	V
t _{rr}	Body Diode Reverse Recovery Time ^{Note E}	V _{DD} = 50V, I _F = 20A, di/dt = 100A/μs	-	47	-	ns
Q _{rr}	Body Diode Reverse Recovery Charge ^{Note E}	V _{DD} = 50V, I _F = 20A, di/dt = 100A/μs	-	55	-	nC

Typical Operating Characteristics

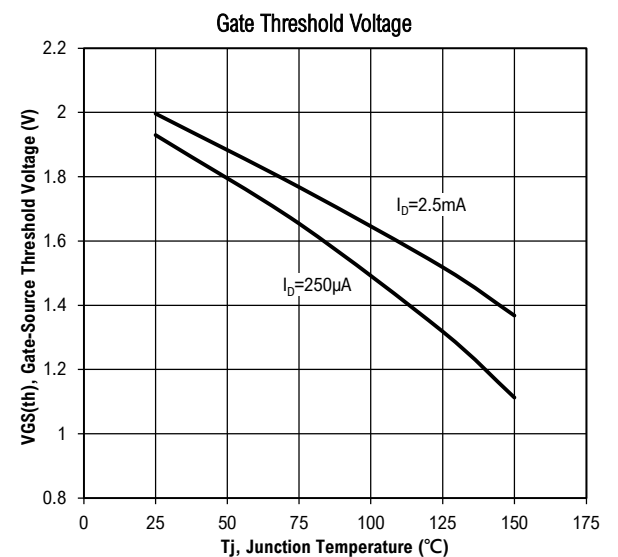
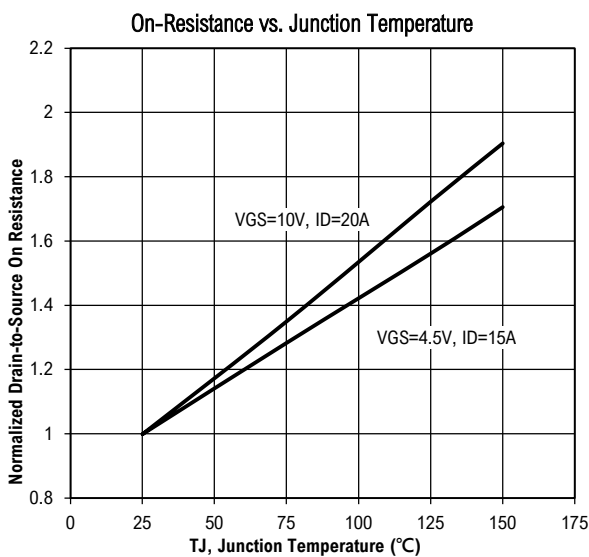
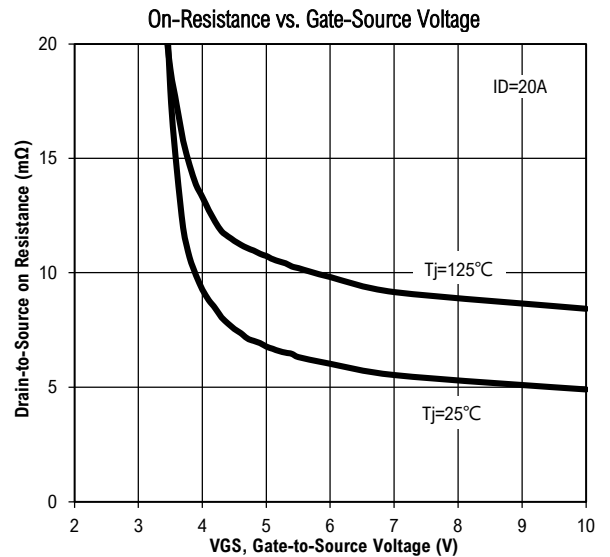
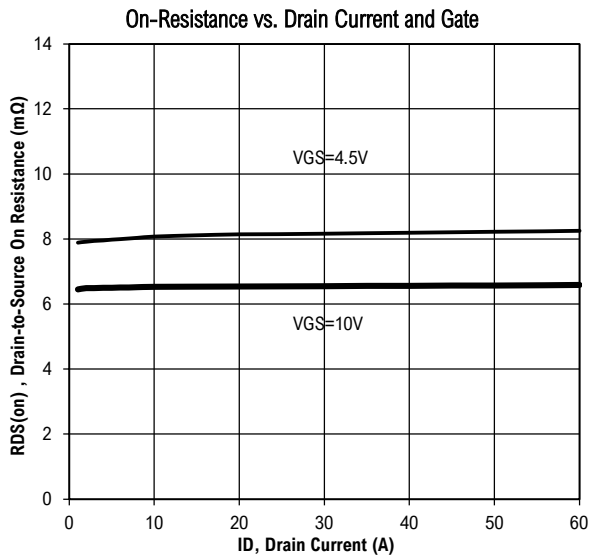
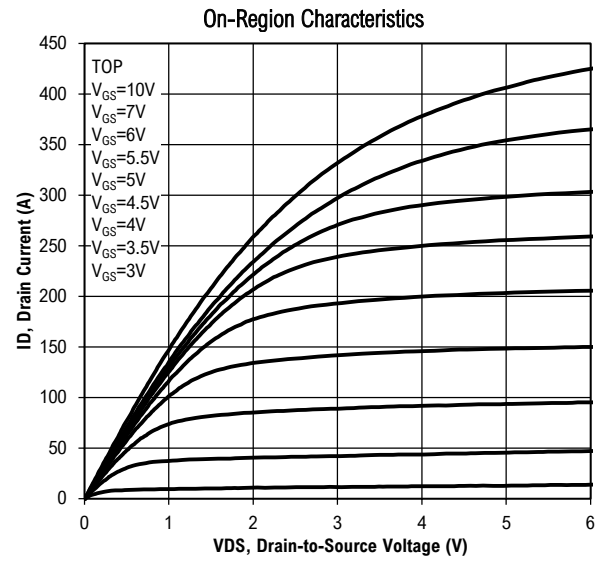
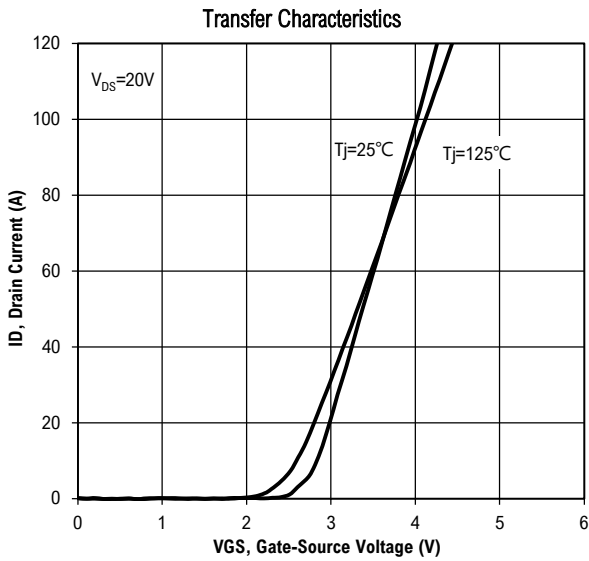

Typical Operating Characteristics (Cont.)

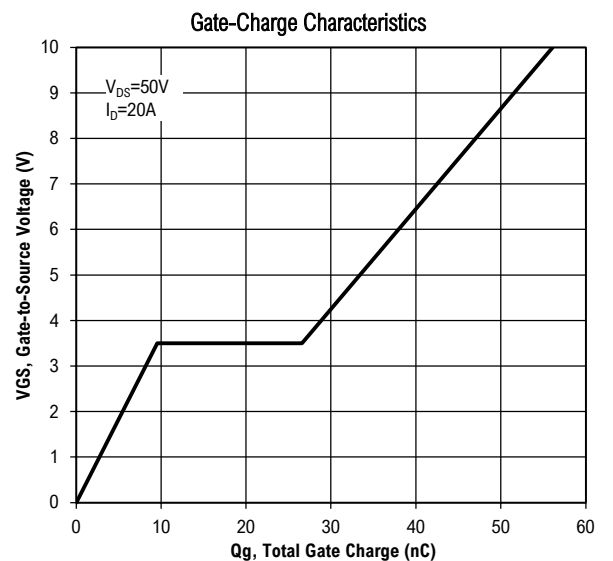
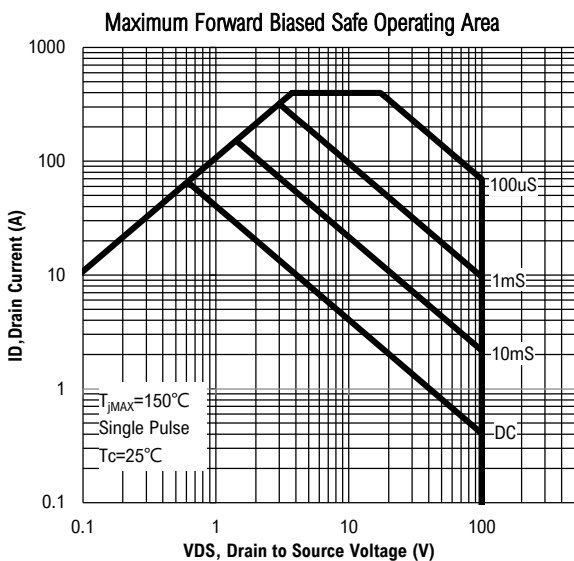
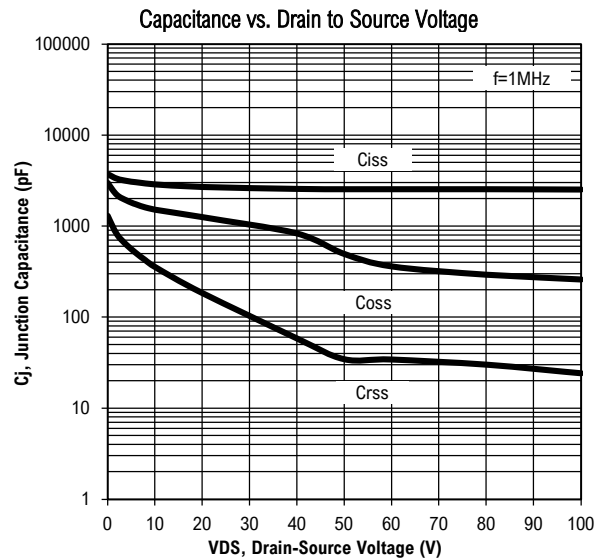
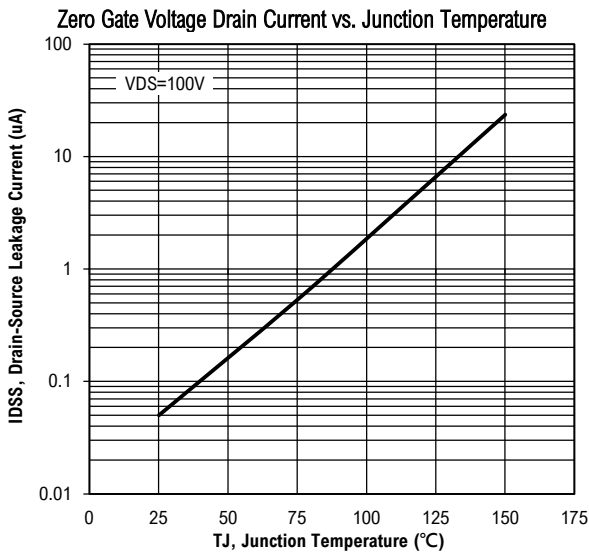
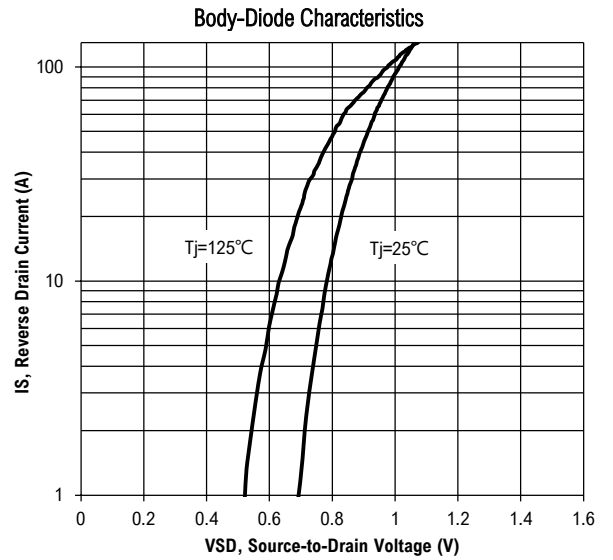
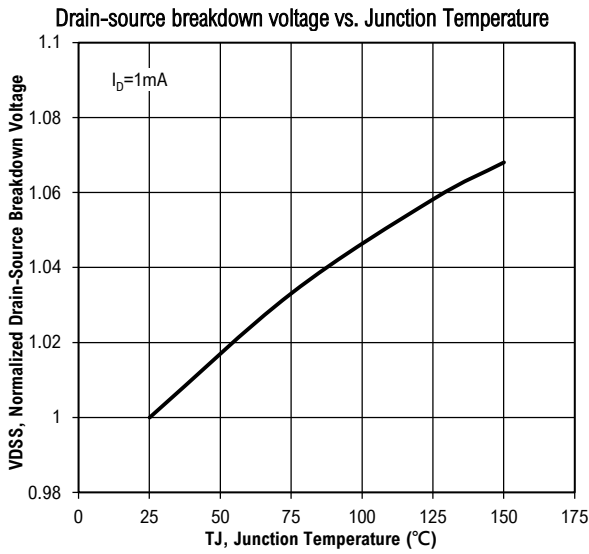

Typical Operating Characteristics (Cont.)

Transient Thermal Resistance

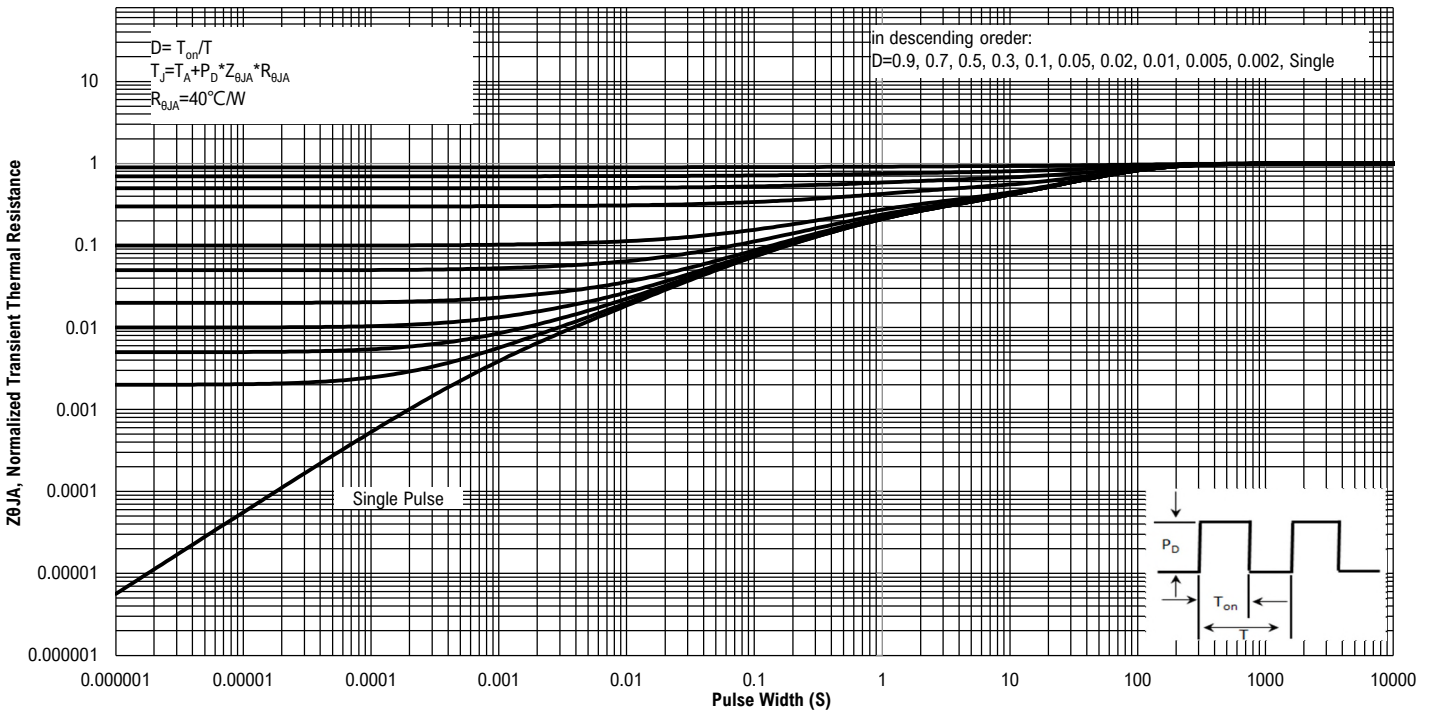
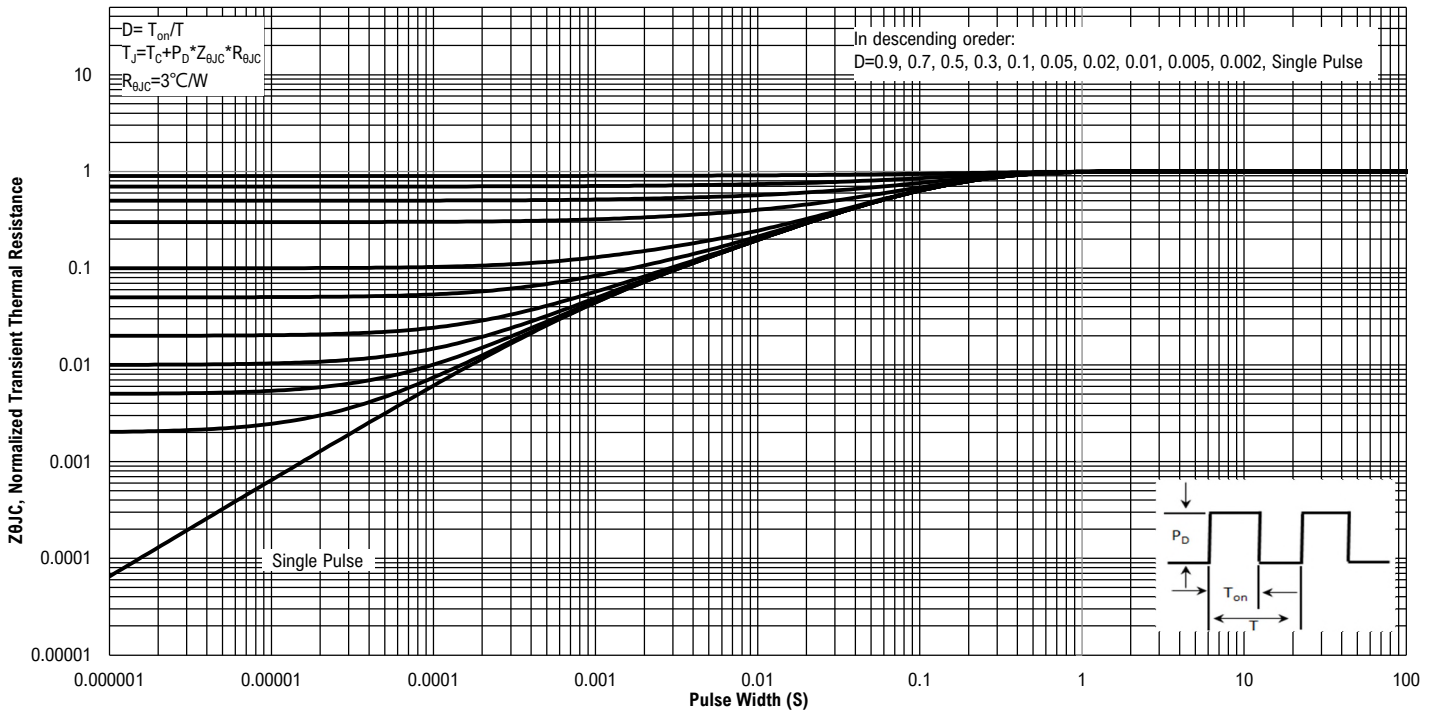

Ordering and Marking Information

Ordering Device No.	Marking	Package	Packing	Quantity
ASDM100R066NF-T	100R066N	TO-220F	Tube	50/Tube

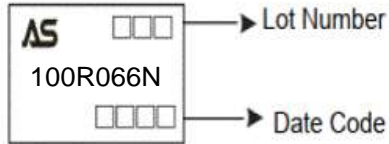
PACKAGE	MARKING
TO-220F	 <p>The diagram shows a TO-220F MOSFET with the following markings: <ul style="list-style-type: none"> AS logo 100R066N (part number) Lot Number (indicated by three empty boxes) Date Code (indicated by four empty boxes) </p>

TO-220F Package Information

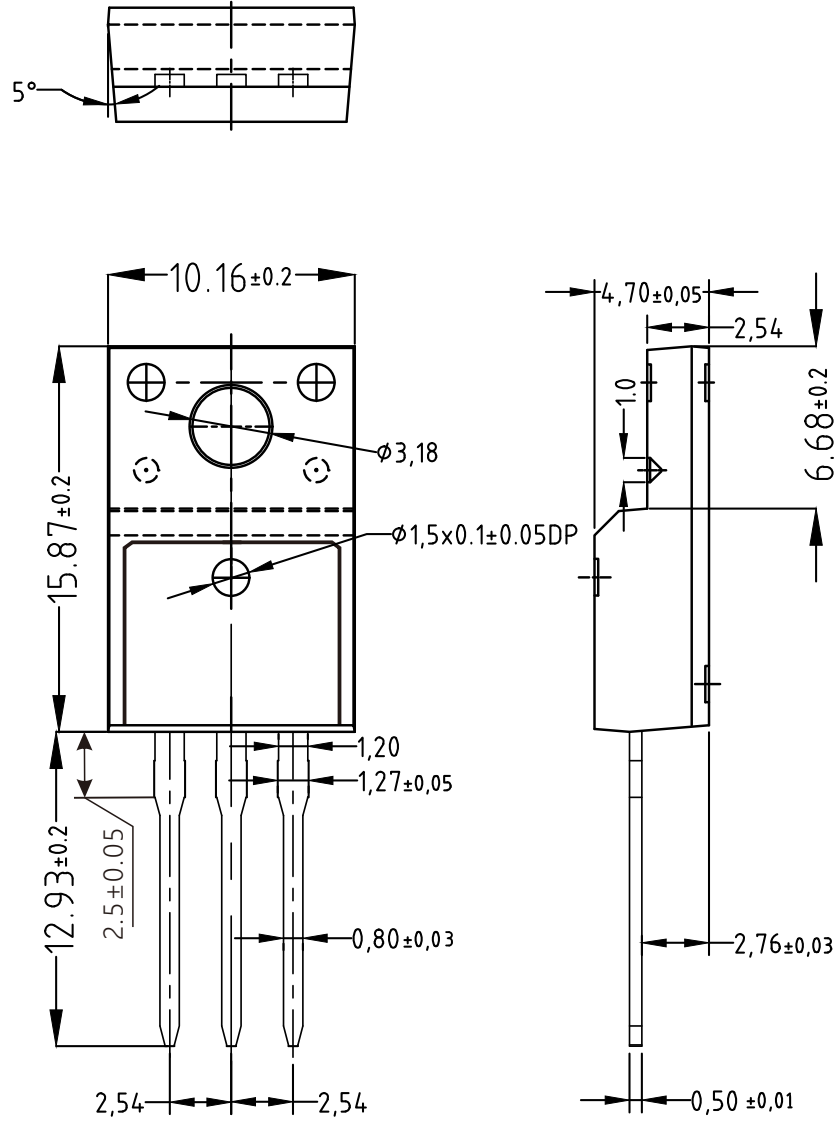

IMPORTANT NOTICE

ShenZhen Ascend Semiconductor incorporated MAKES NO WARRANTY OF ANY KIND, EXPRESS OR IMPLIED, WITH REGARDS TO THIS DOCUMENT, INCLUDING, BUT NOT LIMITED TO, THE IMPLIED WARRANTIES OF MERCHANTABILITY AND FITNESS FOR A PARTICULAR PURPOSE (AND THEIR EQUIVALENTS UNDER THE LAWS OF ANY JURISDICTION).

ShenZhen Ascend Semiconductor Incorporated and its subsidiaries reserve the right to make modifications, enhancements, improvements, corrections or other changes without further notice to this document and any product described herein. ShenZhen Ascend Semiconductor Incorporated does not assume any liability arising out of the application or use of this document or any product described herein; neither does ShenZhen Ascend Semiconductor Incorporated convey any license under its patent or trademark rights, nor the rights of others. Any Customer or user of this document or products described herein in such applications shall assume .

all risks of such use and will agree to hold Ascendsemi Incorporated and all the companies whose products are represented on ShenZhen Ascend Semiconductor Incorporated website, harmless against all damages.

ShenZhen Ascend Semiconductor Incorporated does not warrant or accept any liability whatsoever in respect of any products purchased through unauthorized sales channel. Should Customers purchase or use ShenZhen Ascend Semiconductor Incorporated products for any unintended or unauthorized application, Customers shall indemnify and hold ShenZhen Ascend Semiconductor Incorporated and its representatives harmless against all claims, damages, expenses, and attorney fees arising out of, directly or indirectly, any claim of personal injury or death associated with such unintended or unauthorized application.

www.ascendsemi.com