

General Features

- Super Low Gate Charge
- 100% EAS Guaranteed
- Green Device Available
- Excellent CdV/dt effect decline
- Advanced high cell density Trenchtechnology
- Halongen Free

Applications

- DC-DC primary bridge
- DC-DC Synchronous rectification

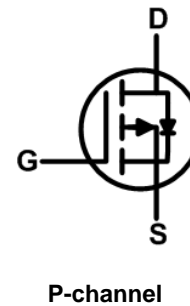
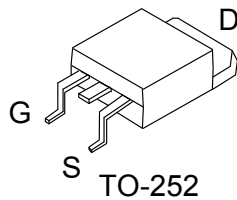

Product Summary



VDS	-60	V
RDS(on),max.@ VGS=10 V	25	mΩ
ID	-50	A

Absolute Maximum Ratings

Symbol	Parameter	Rating	Units
V _{DS}	Drain-Source Voltage	-60	V
V _{GS}	Gate-Source Voltage	±20	V
I _D @T _C =25°C	Continuous Drain Current, V _{GS} @ -10V ¹	-50	A
I _D @T _C =100°C	Continuous Drain Current, V _{GS} @ -10V ¹	-28	A
I _D @T _A =25°C	Continuous Drain Current, V _{GS} @ -10V ¹	-24.3	A
I _D @T _A =70°C	Continuous Drain Current, V _{GS} @ -10V ¹	-23.5	A
I _{DM}	Pulsed Drain Current ²	-80	A
EAS	Single Pulse Avalanche Energy ³	115	mJ
I _{AS}	Avalanche Current	-45	A
P _D @T _C =25°C	Total Power Dissipation ⁴	52	W
P _D @T _A =25°C	Total Power Dissipation ⁴	2	W
T _{STG}	Storage Temperature Range	-55 to 150	°C
T _J	Operating Junction Temperature Range	-55 to 150	°C

Thermal Data

Symbol	Parameter	Typ.	Max.	Unit
R _{θJA}	Thermal Resistance Junction-Ambient ¹	---	62	°C/W
R _{θJC}	Thermal Resistance Junction-Case ¹	---	3.6	°C/W

Electrical Characteristics (T_J=25 °C, unless otherwise noted)

Symbol	Parameter	Conditions	Min.	Typ.	Max.	Unit
BV _{DSS}	Drain-Source Breakdown Voltage	V _{GS} =0V, I _D =-250uA	-60	-70	---	V
ΔBV _{DSS} /ΔT _J	BV _{DSS} Temperature Coefficient	Reference to 25°C, I _D =-1mA	---	-0.03	---	V/°C
R _{DS(ON)}	Static Drain-Source On-Resistance ²	V _{GS} =-10V, I _D =-1A	---	20	25	mΩ
		V _{GS} =-4.5V, I _D =-1	---	25	33	
V _{GS(th)}	Gate Threshold Voltage	V _{GS} =V _{DS} , I _D =-250uA	-1.0	-1.7-	-3.0	V
ΔV _{GS(th)}	V _{GS(th)} Temperature Coefficient		---	4.56	---	mV/°C
I _{DSS}	Drain-Source Leakage Current	V _{DS} =-60V, V _{GS} =0V, T _J =25°C	---	---	1	uA
I _{GSS}	Gate-Source Leakage Current	V _{GS} =±20V, V _{DS} =0V	---	---	±100	nA
g _{fs}	Forward Transconductance	V _{DS} =-5V, I _D =-12A	---	15.4	---	S
R _g	Gate Resistance	V _{DS} =0V, V _{GS} =0V, f=1MHz	---	13.5	---	Ω
Q _g	Total Gate Charge (-4.5V)	V _{DS} =-48V, V _{GS} =-4.5V, I _D =-10A	---	26	---	nC
Q _{gs}	Gate-Source Charge		---	3.08	---	
Q _{gd}	Gate-Drain Charge		---	2.95	---	
T _{d(on)}	Turn-On Delay Time	V _{DD} =-15V, V _{GS} =-10V, R _G =3.3Ω, I _D =-1A	---	28.8	---	ns
T _r	Rise Time		---	19.8	---	
T _{d(off)}	Turn-Off Delay Time		---	60.8	---	
T _f	Fall Time		---	7.2	---	
C _{iss}	Input Capacitance	V _{DS} =-15V, V _{GS} =0V, f=1MHz	---	3447	---	pF
C _{oss}	Output Capacitance		---	223	---	
C _{rss}	Reverse Transfer Capacitance		---	140	---	

Diode Characteristics

Symbol	Parameter	Conditions	Min.	Typ.	Max.	Unit
I _S	Continuous Source Current ^{1,5}	V _G =V _D =0V, Force Current	---	---	-18	A
I _{SM}	Pulsed Source Current ^{2,5}		---	---	-36	A
V _{SD}	Diode Forward Voltage ²	V _{GS} =0V, I _S =-1A, T _J =25°C	---	---	-1.2	V

Note :

- 1.The data tested by surface mounted on a 1 inch² FR-4 board with 2OZ copper.
- 2.The data tested by pulsed , pulse width ≤ 300us , duty cycle ≤ 2%
- 3.The EAS data shows Max. rating . The test condition is V_{DD}=-25V, V_{GS}=-10V, L=0.1mH, I_{AS}=-25.1A
- 4.The power dissipation is limited by 150°C junction temperature
- 5.The data is theoretically the same as I_D and I_{DM} , in real applications , should be limited by total power dissipation.

Typical Characteristics

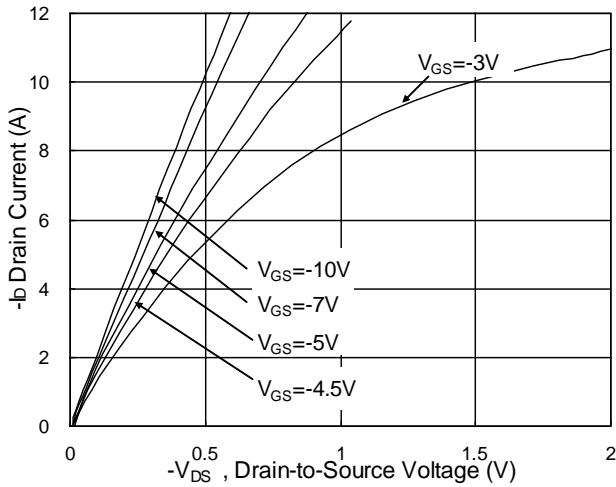

Fig.1 Typical Output Characteristics

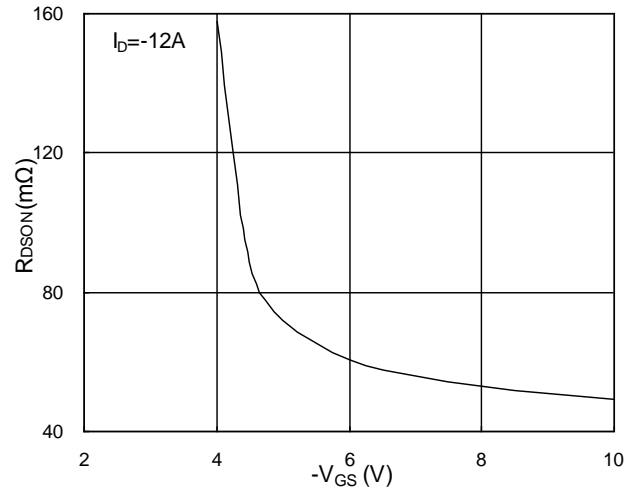

Fig.2 On-Resistance v.s Gate-Source

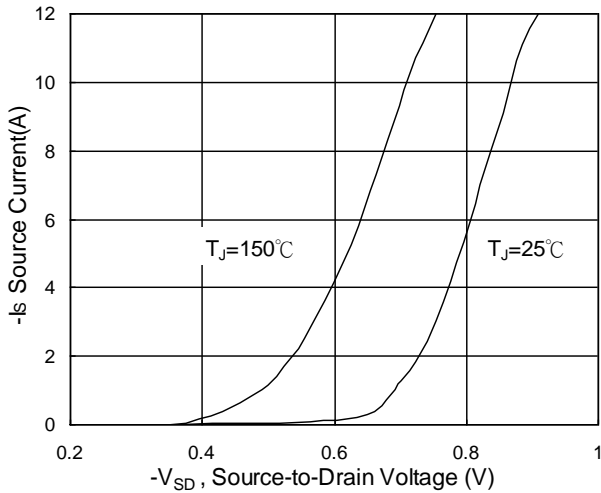

Fig.3 Forward Characteristics of Reverse

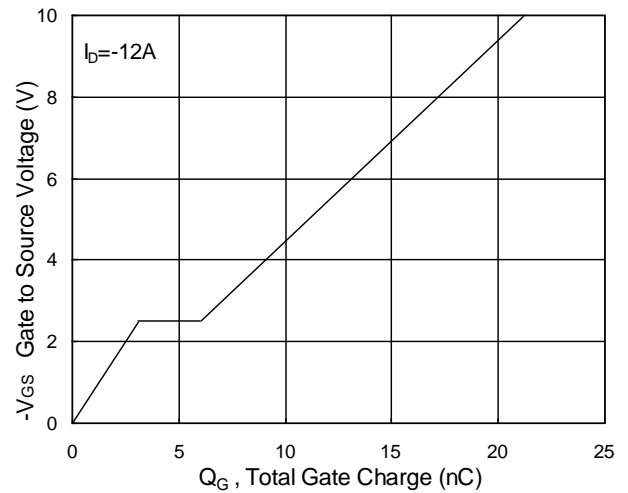

Fig.4 Gate-Charge Characteristics

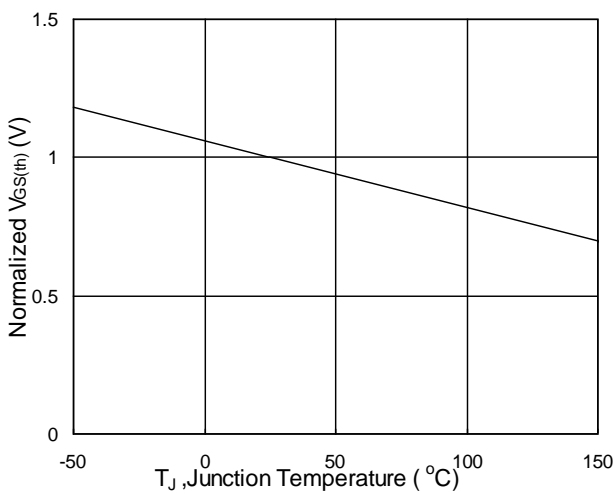

Fig.5 Normalized $V_{GS(th)}$ v.s T_J

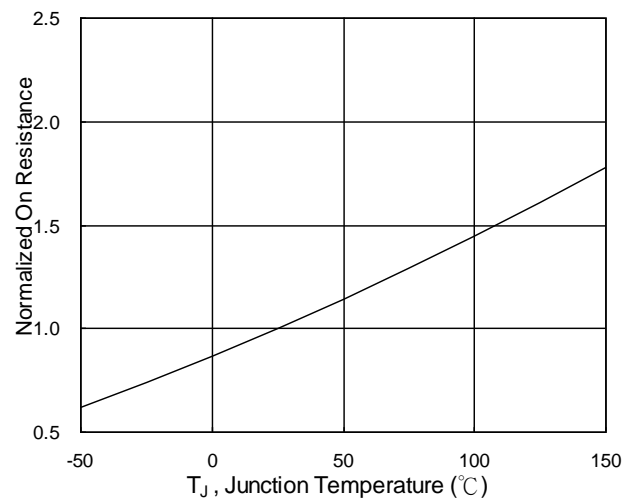

Fig.6 Normalized $R_{DS(on)}$ v.s T_J

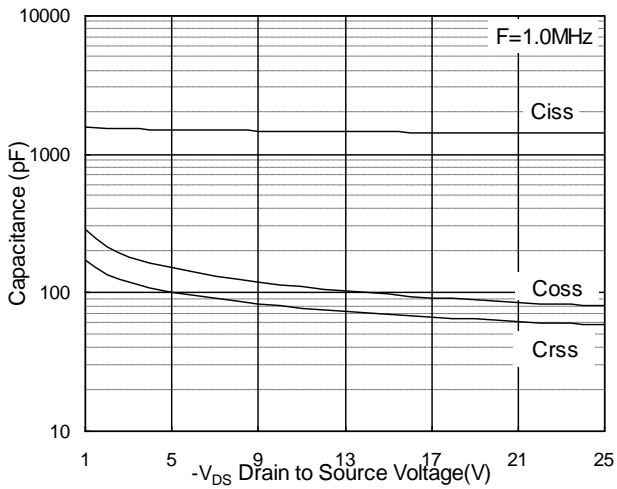

Fig.7 Capacitance

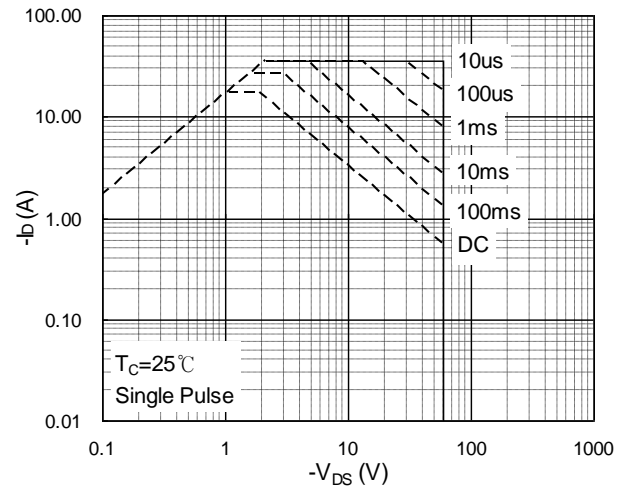

Fig.8 Safe Operating Area

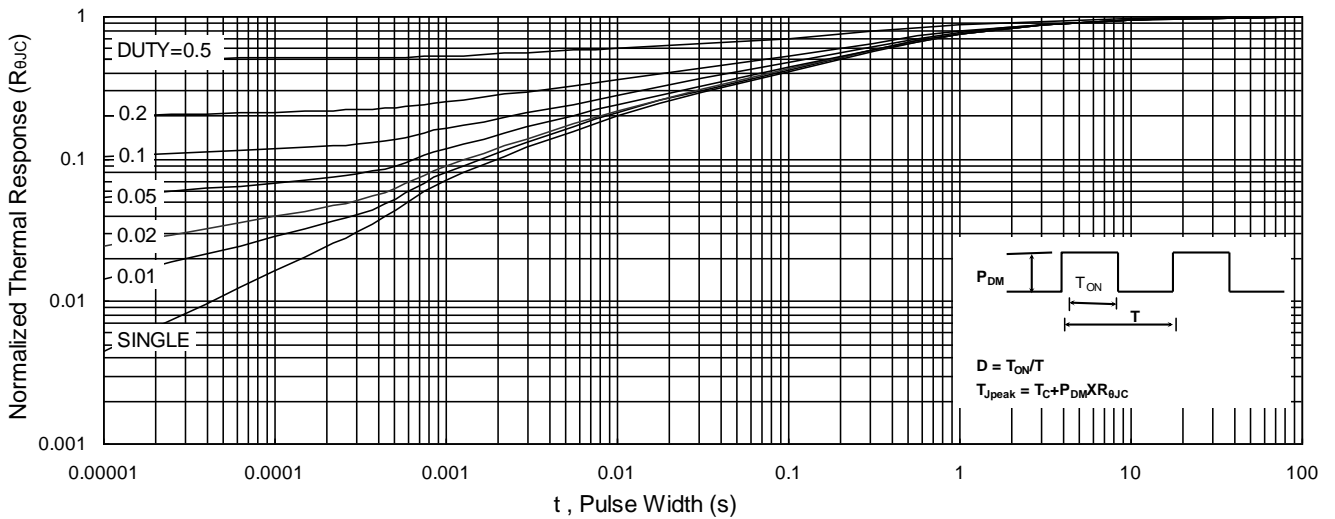

Fig.9 Normalized Maximum Transient Thermal Impedance

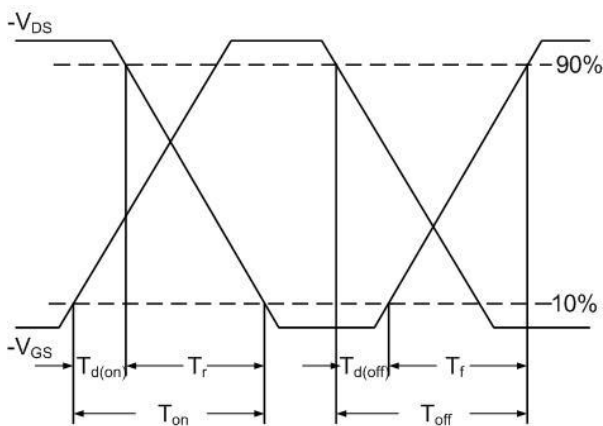

Fig.10 Switching Time Waveform

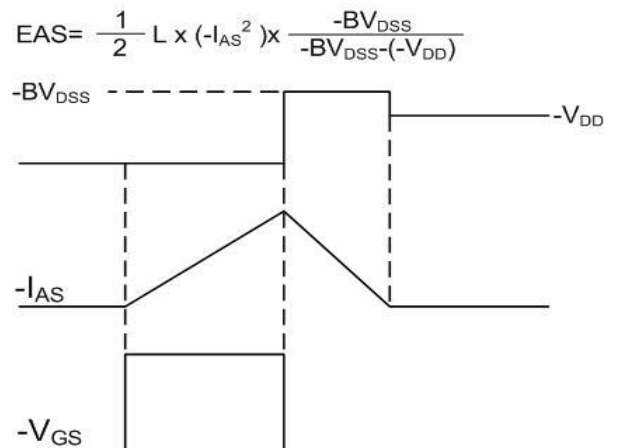
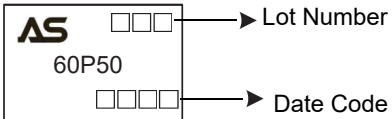
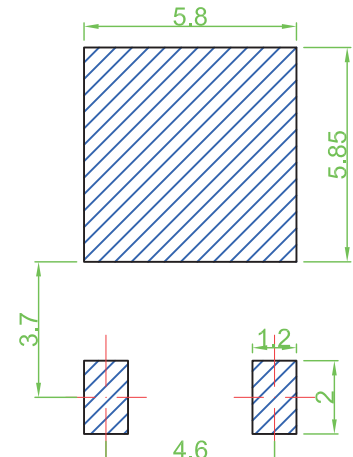
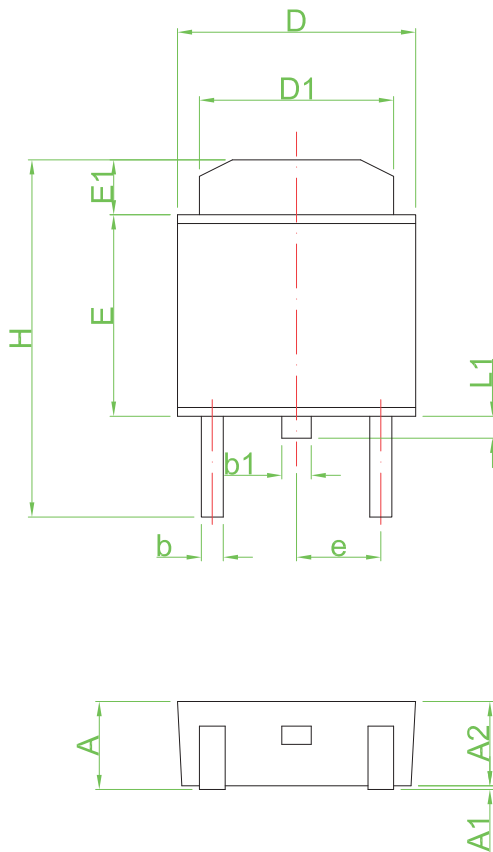

Fig.11 Unclamped Inductive Waveform

Ordering and Marking Information

Device	Marking	Package	Packaging	Quantity
ASDM60P50KQ	60P50	TO-252	Tape&Reel	2500/Reel

PACKAGE	MARKING
TO-252	 <p>AS □□□ → Lot Number 60P50 □□□□ → Date Code</p>

Recommended Land Pattern

Symbol	Dimensions in Millimeters		Dimensions in Inches	
	Min	Max	Min	Max
A	2.25	2.65	0.089	0.104
A1	0.00	0.15	0.000	0.006
A2	2.20	2.40	0.087	0.094
b	0.50	0.70	0.020	0.028
b1	0.70	0.90	0.028	0.035
c	0.46	0.66	0.018	0.026
c1	0.46	0.66	0.018	0.026
D	6.30	6.70	0.248	0.264
D1	5.20	5.40	0.205	0.213
E	5.30	5.70	0.209	0.224
E1	1.40	1.60	0.055	0.063
H	9.40	9.90	0.370	0.390
e	2.30 TYP		0.09 TYP	
L	1.40	1.77	0.055	0.070
L1	0.50	0.70	0.020	0.028
theta	0°	8°	0°	8°

IMPORTANT NOTICE

ShenZhen Ascend Semiconductor incorporated MAKES NO WARRANTY OF ANY KIND, EXPRESS OR IMPLIED, WITH REGARDS TO THIS DOCUMENT, INCLUDING, BUT NOT LIMITED TO, THE IMPLIED WARRANTIES OF MERCHANTABILITY AND FITNESS FOR A PARTICULAR PURPOSE (AND THEIR EQUIVALENTS UNDER THE LAWS OF ANY JURISDICTION).

ShenZhen Ascend Semiconductor Incorporated and its subsidiaries reserve the right to make modifications, enhancements, improvements, corrections or other changes without further notice to this document and any product described herein. ShenZhen Ascend Semiconductor Incorporated does not assume any liability arising out of the application or use of this document or any product described herein; neither does ShenZhen Ascend Semiconductor Incorporated convey any license under its patent or trademark rights, nor the rights of others. Any Customer or user of this document or products described herein in such applications shall assume .

all risks of such use and will agree to hold Ascendsemi Incorporated and all the companies whose products are represented on ShenZhen Ascend Semiconductor Incorporated website, harmless against all damages.

ShenZhen Ascend Semiconductor Incorporated does not warrant or accept any liability whatsoever in respect of any products purchased through unauthorized sales channel. Should Customers purchase or use ShenZhen Ascend Semiconductor Incorporated products for any unintended or unauthorized application, Customers shall indemnify and hold ShenZhen Ascend Semiconductor Incorporated and its representatives harmless against all claims, damages, expenses, and attorney fees arising out of, directly or indirectly, any claim of personal injury or death associated with such unintended or unauthorized application.

www.ascendsemi.com