



Feature

- 100% EAS Guaranteed
- Green Device Available
- Super Low Gate Charge
- Excellent CdV/dt effect decline
- Advanced high cell density Trench technology

Product Summary



V_{DS}	30	V
$R_{DS(on),typ} V_{GS}=10V$	4.5	m Ω
I_D	65	A

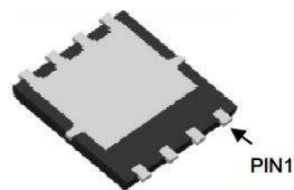

DFN3.3*3.3-8L

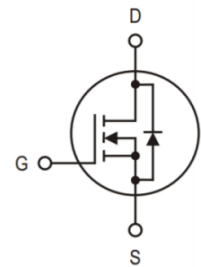
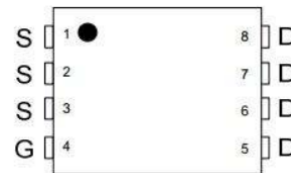
Maximum ratings, at $T_A=25\text{ }^\circ\text{C}$, unless otherwise specified

Symbol	Parameter	Rating	Unit
$V_{(BR)DSS}$	Drain-Source breakdown voltage	30	V
I_S	Diode continuous forward current	$T_C=25^\circ\text{C}$ 65	A
I_D	Continuous drain current @ $V_{GS}=10V$	$T_C=25^\circ\text{C}$ 65	A
		$T_C=100^\circ\text{C}$ 40	A
I_{DM}	Pulse drain current tested ①	$T_A=25^\circ\text{C}$ 140	A
EAS	Avalanche energy, single pulsed ②	140	mJ
P_D	Maximum power dissipation	$T_C=25^\circ\text{C}$ 40	W
V_{GS}	Gate-Source voltage	± 20	V
MSL		Level 3	
T_{STG}, T_J	Storage and junction temperature range	-55 to 150	$^\circ\text{C}$

Thermal Characteristics

Symbol	Parameter	Typical	Unit
$R_{\theta JL}$	Thermal Resistance, Junction-to-Lead	40	$^\circ\text{C/W}$
$R_{\theta JA}$	Thermal Resistance, Junction-to-Ambient	75	$^\circ\text{C/W}$



Typical Electrical Characteristics

Symbol	Parameter	Condition	Min.	Typ.	Max.	Unit
Static Electrical Characteristics @ T_J = 25°C (unless otherwise stated)						
V _{(BR)DSS}	Drain-Source Breakdown Voltage	V _{GS} =0V, I _D =250μA	30	--	--	V
I _{DSS}	Zero Gate Voltage Drain Current(T _J =25°C)	V _{DS} =30V, V _{GS} =0V	--	--	1	μA
	Zero Gate Voltage Drain Current(T _J =125°C)	V _{DS} =30V, V _{GS} =0V	--	--	100	μA
I _{GSS}	Gate-Body Leakage Current	V _{GS} =±20V, V _{DS} =0V	--	--	±100	nA
V _{GS(TH)}	Gate Threshold Voltage	V _{DS} =V _{GS} , I _D =250μA	1.0	1.7	2.5	V
R _{DS(ON)}	Drain-Source On-State Resistance ③	V _{GS} =10V, I _D =30A	--	4.5	5	mΩ
R _{DS(ON)}	Drain-Source On-State Resistance ③	V _{GS} =4.5V, I _D =15A	--	5.5	6	mΩ
Dynamic Electrical Characteristics @ T_J = 25°C (unless otherwise stated)						
C _{iss}	Input Capacitance	V _{DS} =15V, V _{GS} =0V, f=1MHz		3075		pF
C _{oss}	Output Capacitance			400		pF
C _{rss}	Reverse Transfer Capacitance			315		pF
R _g	Gate Resistance	f=1MHz	--	1.4	--	Ω
Q _g	Total Gate Charge	V _{DS} =15V, I _D =15A, V _{GS} =10V	--	31.6	--	nC
Q _{gs}	Gate-Source Charge		--	6.07	--	nC
Q _{gd}	Gate-Drain Charge		--	13.8	--	nC
Switching Characteristics						
t _{d(on)}	Turn-on Delay Time	V _{DD} =15V, I _D =20A, R _G =1.5Ω, V _{GS} =10V	--	11.2	--	nS
t _r	Turn-on Rise Time		--	49	--	nS
t _{d(off)}	Turn-Off Delay Time		--	35	--	nS
t _f	Turn-Off Fall Time		--	7.8	--	nS
Source- Drain Diode Characteristics @ T_J = 25°C (unless otherwise stated)						
V _{SD}	Forward on voltage	I _{SD} =2A, V _{GS} =0V	--	0.8	1.0	V
t _{rr}	Reverse Recovery Time	T _J =25°C, I _{sd} =10A, V _{GS} =0V	--	20	--	nS
Q _{rr}	Reverse Recovery Charge	di/dt=500A/μs		11.5		nC

NOTE:

- ① Repetitive rating; pulse width limited by max. junction temperature.
- ② Limited by T_{Jmax}, starting T_J = 25°C, L = 0.1mH, R_G = 25Ω, I_{AS} = 48A, V_{GS} = 10V. Part not recommended for use above this value
- ③ Pulse width ≤ 300μs; duty cycle ≤ 2%.



A

Typical Characteristics

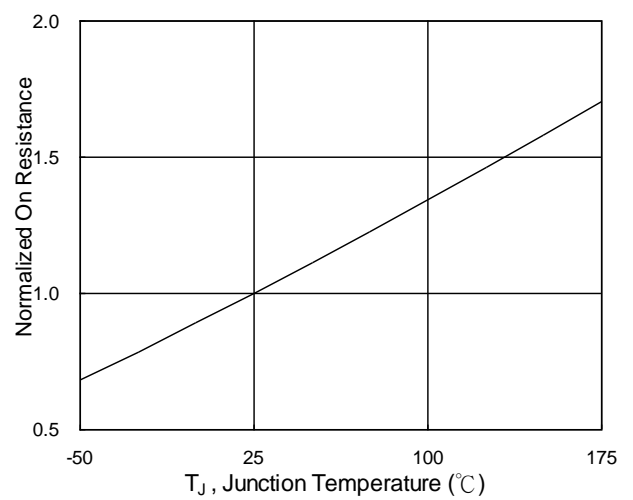
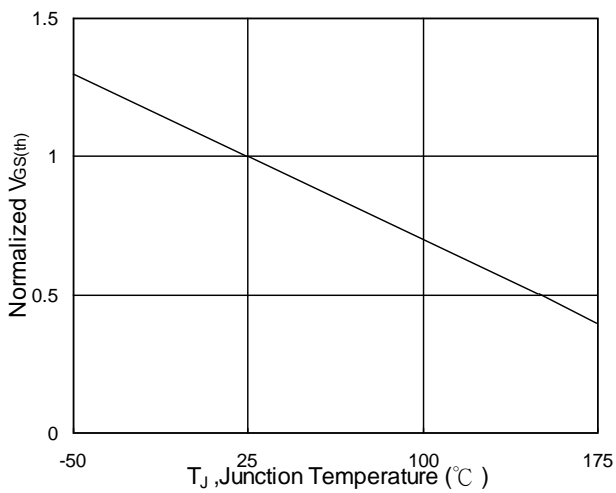
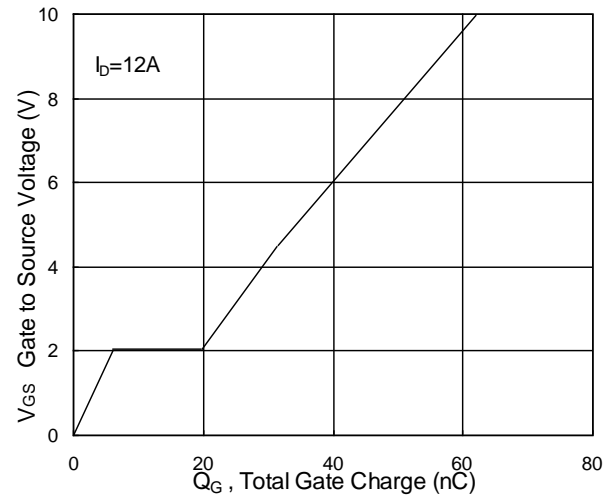
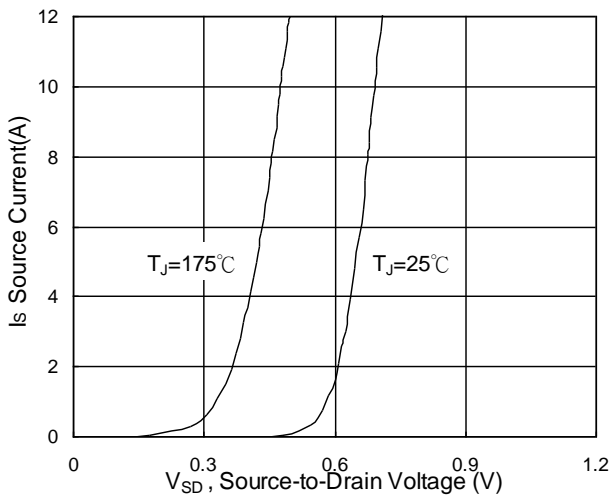
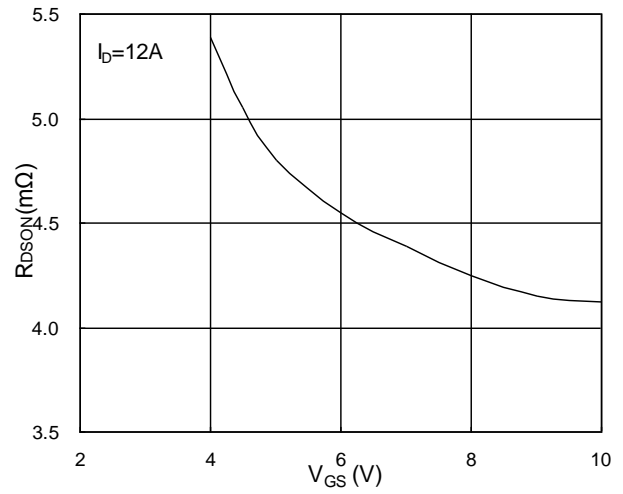
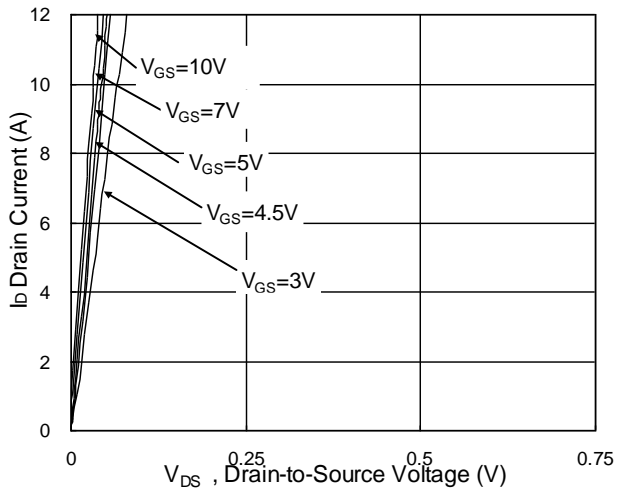



Typical Characteristics

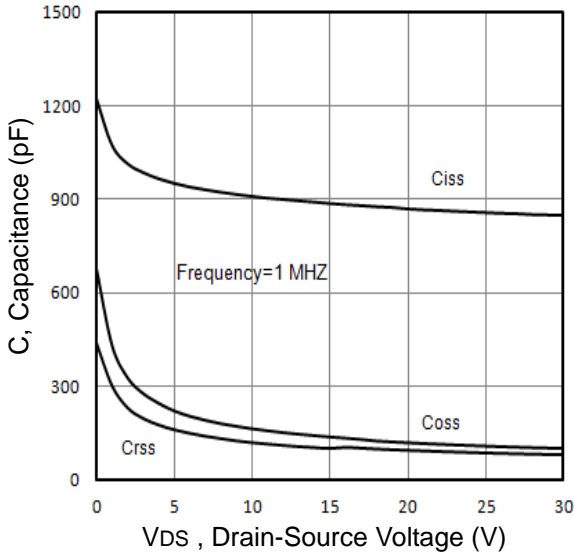

Fig7. Typical Capacitance Vs.Drain-Source Voltage

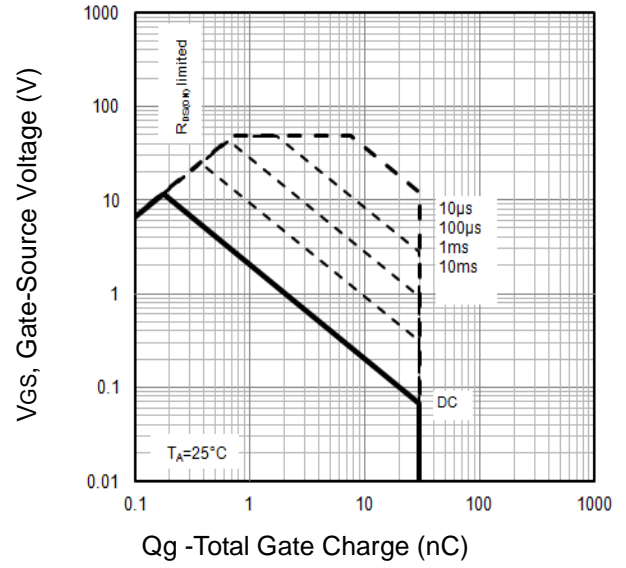
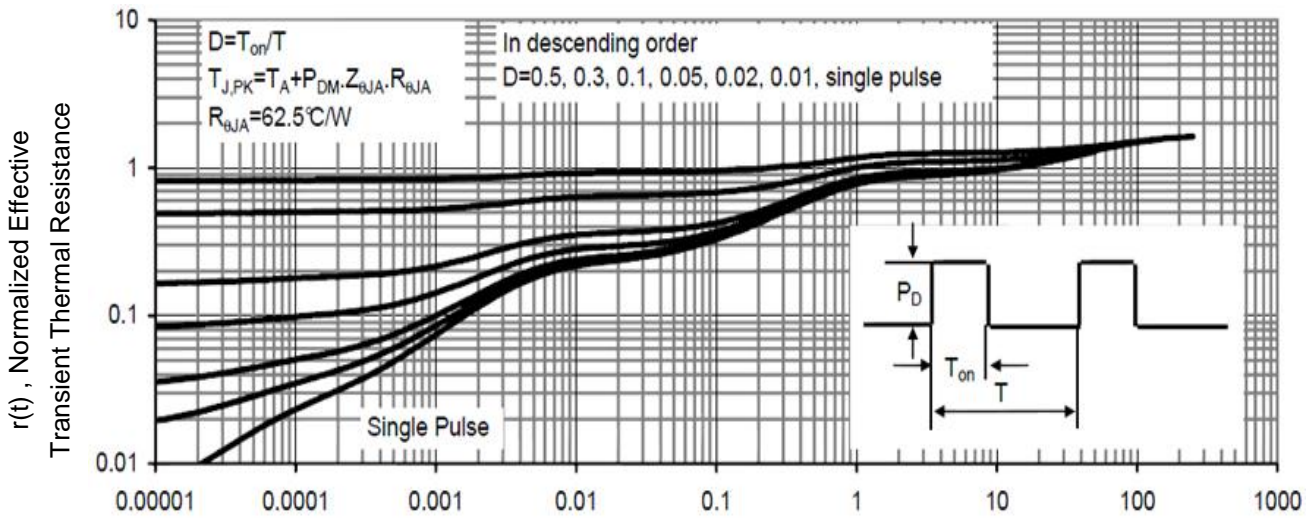

Fig8. Typical Gate Charge Vs.Gate-Source Voltage



T1, Square Wave Pulse Duration(sec)

Fig9. T1, Transient Thermal Response Curve

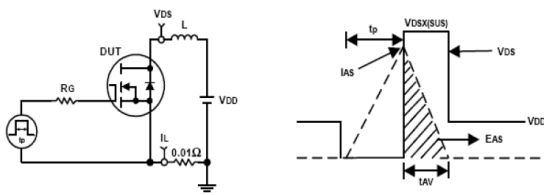

Fig10. Unclamped Inductive Test Circuit and waveforms

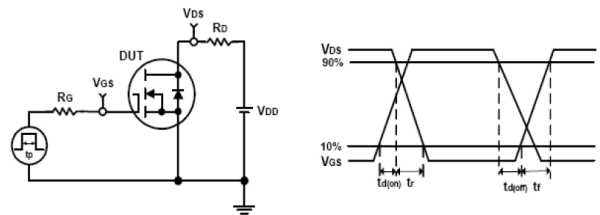

Fig11. Switching Time Test Circuit and waveforms



Ordering and Marking Information

Device	Marking	Package	Packaging	Quantity
ASDM30N65E	30N65	DFN3.3*3.3-8L	Tape&Reel	5000/Reel

PACKAGE	MARKING
DFN3.3*3.3-8L	

Ordering Number		Package
Lead Free	Halogen Free	
ASDM30N65-E-R	ASDM30N65G-E-R	DFN3.3*3.3-8L

<p>ASDM30N65G-E-R</p>	<p>1 T:Tube,R:Tape Reel</p> <p>2 E:DFN3.3*3.3-8L</p> <p>3 blank: Lead Free G:Halogen Free and Lead Free</p>
-----------------------	---



ASCENDSEMI

ASDM30N65E

30V/65A N-CHANNEL MOSFET

DFN (3.3×3.3)-8L(P0.65T0.80) PACKAGE OUTLINE DIMENSIONS

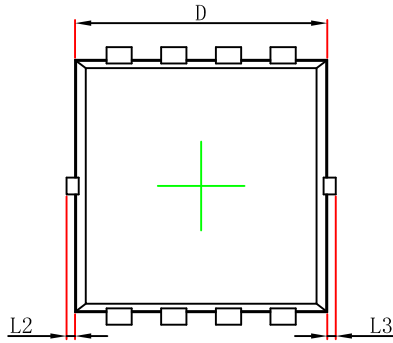

Top View
[顶视图]

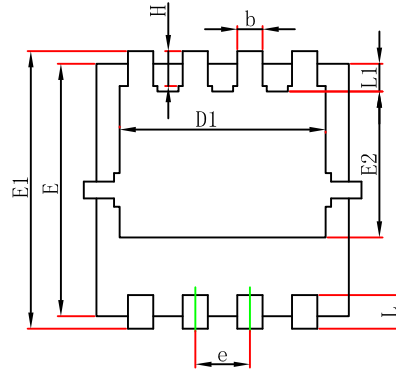

Bottom View
[背视图]

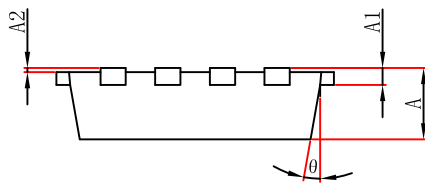

Side View
[侧视图]

Symbol	Dimensions In Millimeters		Dimensions In Inches	
	Min.	Max.	Min.	Max.
A	0.650	0.850	0.026	0.033
A1	0.152 REF.		0.006 REF.	
A2	0~0.05		0~0.002	
D	2.900	3.100	0.114	0.122
D1	2.300	2.600	0.091	0.102
E	2.900	3.100	0.114	0.122
E1	3.150	3.450	0.124	0.136
E2	1.535	1.935	0.060	0.076
b	0.200	0.400	0.008	0.016
e	0.550	0.750	0.022	0.030
L	0.300	0.500	0.012	0.020
L1	0.180	0.480	0.007	0.019
L2	0~0.100		0~0.004	
L3	0~0.100		0~0.004	
H	0.315	0.515	0.012	0.020
θ	9°	13°	9°	13°



IMPORTANT NOTICE

Xi'an Ascend Semiconductor incorporated MAKES NO WARRANTY OF ANY KIND, EXPRESS OR IMPLIED, WITH REGARDS TO THIS DOCUMENT, INCLUDING, BUT NOT LIMITED TO, THE IMPLIED WARRANTIES OF MERCHANTABILITY AND FITNESS FOR A PARTICULAR PURPOSE (AND THEIR EQUIVALENTS UNDER THE LAWS OF ANY JURISDICTION).

Xi'an Ascend Semiconductor Incorporated and its subsidiaries reserve the right to make modifications, enhancements, improvements, corrections or other changes without further notice to this document and any product described herein. Xi'an Ascend Semiconductor Incorporated does not assume any liability arising out of the application or use of this document or any product described herein; neither does Xi'an Ascend Semiconductor Incorporated convey any license under its patent or trademark rights, nor the rights of others. Any Customer or user of this document or products described herein in such applications shall assume .

all risks of such use and will agree to hold Ascendsemi Incorporated and all the companies whose products are represented on Xi'an Ascend Semiconductor Incorporated website, harmless against all damages.

Xi'an Ascend Semiconductor Incorporated does not warrant or accept any liability whatsoever in respect of any products purchased through unauthorized sales channel. Should Customers purchase or use Xi'an Ascend Semiconductor Incorporated products for any unintended or unauthorized application, Customers shall indemnify and hold Xi'an Ascend Semiconductor Incorporated and its representatives harmless against all claims, damages, expenses, and attorney fees arising out of, directly or indirectly, any claim of personal injury or death associated with such unintended or unauthorized application.

www.ascendsemi.com