

Cable feed-through plates - MC-25/27-MULTI-67-PVO-BK - 1415237

Please be informed that the data shown in this PDF Document is generated from our Online Catalog. Please find the complete data in the user's documentation. Our General Terms of Use for Downloads are valid (<http://phoenixcontact.com/download>)



Cable feed-through plates, No. of conductors: 27, Length: 92 mm, Width: 222 mm, Height: 43 mm, Color: black

Product Features

- Oil-resistant material



Key Commercial Data

Packing unit	1 pc
Weight per Piece (excluding packing)	280.0 g
Custom tariff number	39269097
Country of origin	Finland

Technical data

Dimensions

Length	92 mm
Width	222 mm
Height	43 mm
Drill hole distance, horizontal	62 mm
Drill hole distance, vertical	194 mm
Inside height	23 mm
Outside height	30 mm
External cable diameter	13x 10 mm ... 14 mm
	4x 8 mm ... 12 mm
	2x 20 mm ... 26 mm
	4x 5 mm ... 7 mm
	4x 8 mm ... 12 mm

Ambient conditions

Cable feed-through plates - MC-25/27-MULTI-67-PVO-BK - 1415237

Technical data

Ambient conditions

Degree of protection	IP66 (Minimum sheet thickness ≥ 2.5 mm)
	IP67 (Minimum sheet thickness ≥ 2.5 mm)
Ambient temperature (operation)	-40 °C ... 100 °C

General

No. of conductors	27
Material	TPE-SEBS
Flammability rating according to UL 94	V0
Color	black
Torque	1.5 Nm ... 2 Nm (Mounting screws)
Note	incl. mounting screws
Installation instructions	M8 mounting screw, torque: 1.5 - 2.0 Nm, SW5 Allen key
	The mounting screws included should be used for assembly. Assembly steps: 1) Fix multigates with the mounting screws provided (observe torque), 2) Make a hole in the membrane (with screwdriver) or cut off the tip of the cone, 3) Guide the cable through the opening, 4) Strip back cable approx. 20 mm (to improve strain relief).

Classifications

eCl@ss

eCl@ss 5.1	23110102
eCl@ss 6.0	23110102

ETIM

ETIM 5.0	EC001004
----------	----------

Drawings

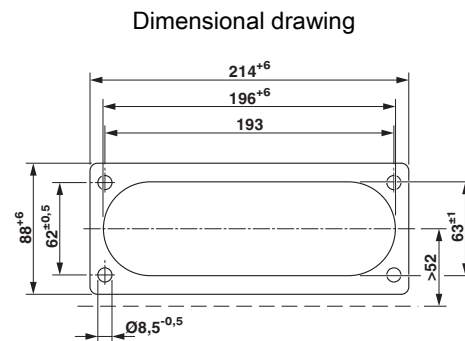
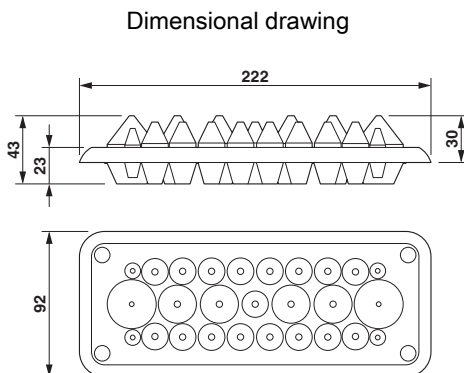

Wall cutout drawing

