

»Features

- Simple Drive Requirement
- Small Package Outline
- Surface Mount Device
- RoHS Compliant & Halogen-Free

BVDSS	-30V
RDS(ON)typ	50mΩ
ID	4.2A

»Description

CT3401M is from Coretong innovated design and silicon process technology to achieve the lowest possible on- resistance and fast switching performance. It provides the designer with an extreme efficient device for use in a wide range of

»Schematic & PIN Configuration

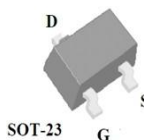
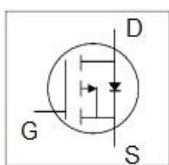

SOT-23

»Absolute Maximum Ratings@T_j=25°C(unless otherwise specified)

Symbol	Parameter	Rating	Units
VDS	Drain-Source Voltage	-30	V
VGS	Gate-Source Voltage	±12	V
I _D @T _A =25°C	Drain Current, V _{GS} @ 10V ₁	-4.2	A
I _D @T _A =70°C	Drain Current, V _{GS} @ 10V ₁	-3.5	A
I _{DM}	Pulsed Drain Current ₂	-16	A
P _D @T _A =25°C	Total Power Dissipation ₃	0.4	W
T _{STG}	Storage Temperature Range	-55 to 150	°C
T _J	Operating Junction Temperature Range	150	°C

»Thermal Data

Symbol	Parameter	Value	Unit
Rthj-a	Maximum Thermal Resistance, Junction-ambient ₃	70	°C/W

»Electrical Characteristics@T_j=25 oC(unless otherwise specified)

Symbol	Parameter	Test Conditions	Min.	Typ.	Max.	Units
BV _{DSS}	Drain-Source Breakdown Voltage	VGS=0V, ID=250uA	-30	-	-	V
RDS(ON)	Static Drain-Source On-Resistance	VGS=10V, ID=-4.2A	-	50	70	mΩ
		VGS=-4.5V, ID=-4A	-	60	80	mΩ
		VGS=-2.5V, ID=-4A	-	82	120	mΩ
V _{GS(th)}	Gate Threshold Voltage	VDS=VGS, ID=250uA	-0.6	-0.9	-1.3	V
g _{fs}	Forward Transconductance	VDS=5V, ID=-4A	7	-	-	S
I _{DSS}	Drain-Source Leakage Current	VDS=24V, VGS=0V	-	-	-1	uA
I _{GSS}	Gate-Source Leakage	VGS=±12V, VDS=0V	-	-	±100	nA
Q _g	Total Gate Charge	ID=4A	-	7.4	-	nC
Q _{gs}	Gate-Source Charge	VDS=-15V	-	1.3	-	nC
Q _{gd}	Gate-Drain ("Miller") Charge	VGS=-4.5V	-	2.6	-	nC
t _{d(on)}	Turn-on Delay Time	VDS=-15V ID=3.6A RG=3.3Ω VGS=-10V	-	2.64	-	ns
t _r	Rise Time		-	10	-	ns
t _{d(off)}	Turn-off Delay Time		-	52	-	ns
t _f	Fall Time		-	16.2	-	ns
C _{iss}	Input Capacitance	VGS=0V	-	740	-	pF
C _{oss}	Output Capacitance	VDS=-15V	-	51	-	pF
Crss	Reverse Transfer Capacitance	f=1.0MHz	-	44	-	pF

»Source-Drain Diode

Symbol	Parameter	Test Conditions	Min.	Typ.	Max.	Units
V _{SD}	Forward On Voltage ²	I _S =4A, VGS=0V	-	-	-1.3	V

Notes:

- 1.Pulse width limited by Max. junction temperature.
- 2.Pulse test
- 3.Surface mounted on 1 in² 2oz copper pad of FR4 board, t ≤10sec ; 300°C/W when mounted on min. copper pad.

Typical Performance Characteristics

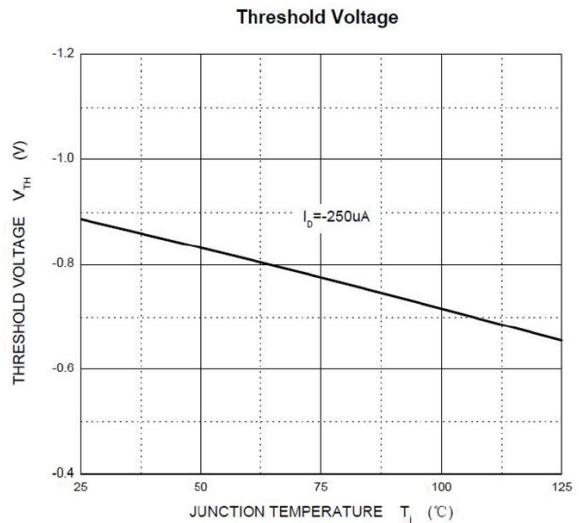
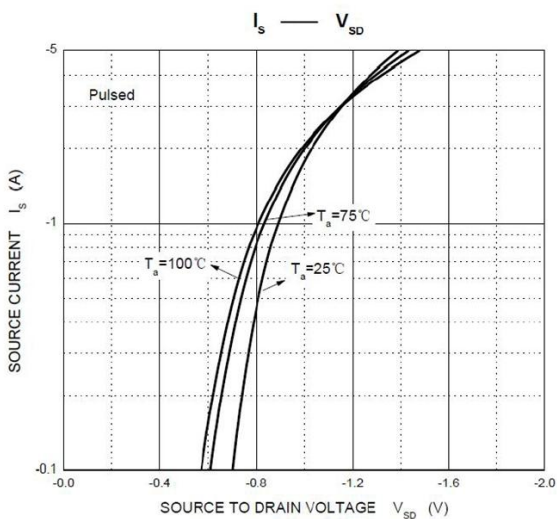
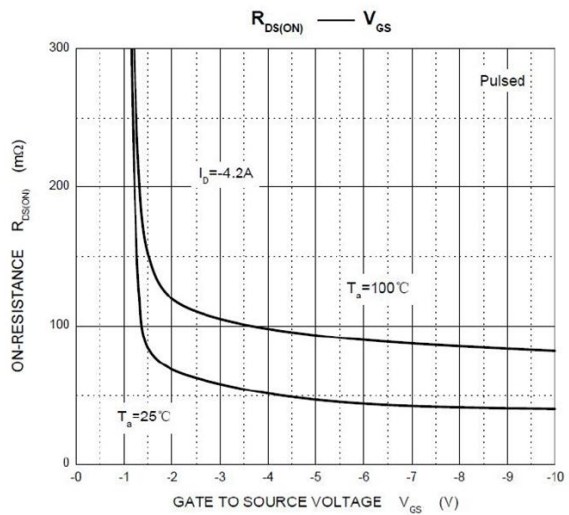
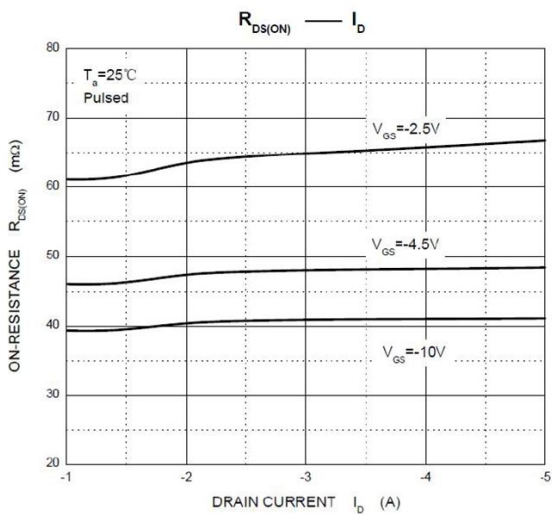
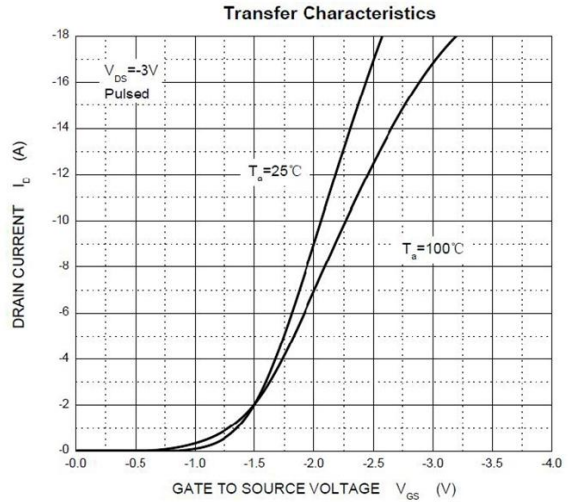
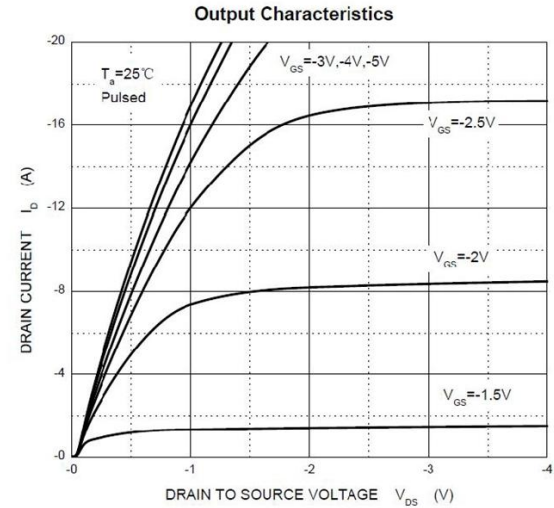

»Package Outline : SOT-23

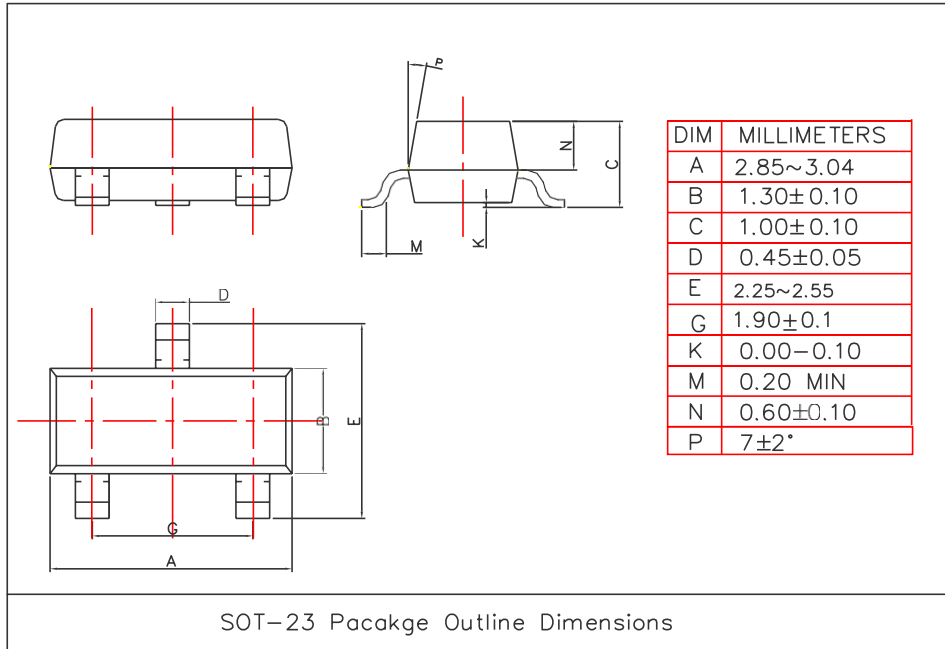

»SOT-23 FOOTPRINT:(mm)

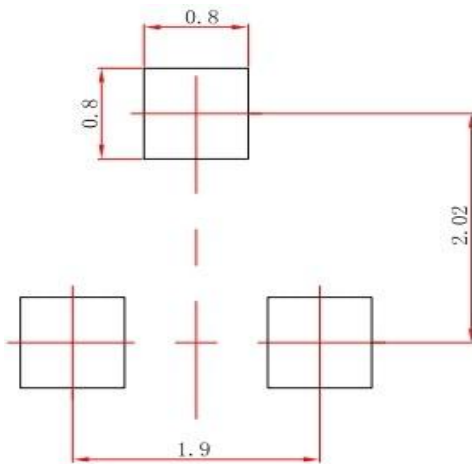

»Ordering information

Order code	Package	Base qty	Delivery mode
CT3401M	SOT-23	3k	Tape and reel