

# NLSV8T240

## 8-Bit Dual-Supply Inverting Level Translator

The NLSV8T240 is a 8-bit configurable dual-supply voltage level translator. The input  $A_n$  and output  $B_n$  ports are designed to track two different power supply rails,  $V_{CCA}$  and  $V_{CCB}$  respectively. Both supply rails are configurable from 0.9 V to 4.5 V allowing universal low-voltage translation from the input  $A_n$  to the output  $B_n$  port.

### Features

- Wide  $V_{CCA}$  and  $V_{CCB}$  Operating Range: 0.9 V to 4.5 V
- High-Speed w/ Balanced Propagation Delay
- Inputs and Outputs have OVT Protection to 4.5 V
- Non-preferential  $V_{CCA}$  and  $V_{CCB}$  Sequencing
- Outputs at 3-State until Active  $V_{CC}$  is Reached
- Power-Off Protection
- Outputs Switch to 3-State with  $V_{CCB}$  at GND
- Ultra-Small Packaging: 4.0 mm x 2.0 mm UDFN20
- This is a Pb-Free Device

### Typical Applications

- Mobile Phones, PDAs, Other Portable Devices

### Important Information

- ESD Protection for All Pins:  
HBM (Human Body Model) > 7000 V

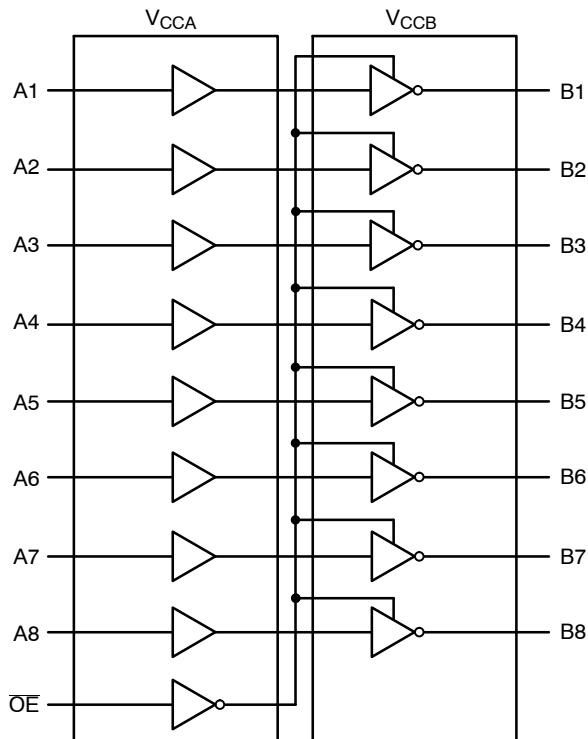

Figure 1. Logic Diagram



ON Semiconductor®

<http://onsemi.com>



UDFN20  
MU SUFFIX  
CASE 517AK

### MARKING DIAGRAM

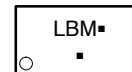

LB = Specific Device Code  
M = Date Code  
▪ = Pb-Free Package

(Note: Microdot may be in either location)

### PIN ASSIGNMENT

$V_{CCA}$	1	20	$V_{CCB}$
A1	2	19	B1
A2	3	18	B2
A3	4	17	B3
A4	5	16	B4
A5	6	15	B5
A6	7	14	B6
A7	8	13	B7
A8	9	12	B8
GND	10	11	$\overline{OE}$

(Top View)

### ORDERING INFORMATION

Device	Package	Shipping†
NLSV8T240MUTAG	UDFN20 (Pb-Free)	3000/Tape & Reel

†For information on tape and reel specifications, including part orientation and tape sizes, please refer to our Tape and Reel Packaging Specification Brochure, BRD8011/D.

# NLSV8T240

## PIN ASSIGNMENT

PIN	FUNCTION
V <sub>CCA</sub>	Input Port DC Power Supply
V <sub>CCB</sub>	Output Port DC Power Supply
GND	Ground
A <sub>n</sub>	Input Port
B <sub>n</sub>	Output Port
$\overline{OE}$	Output Enable

## TRUTH TABLE

Inputs		Outputs
$\overline{OE}$	A <sub>n</sub>	B <sub>n</sub>
L	L	H
L	H	L
H	X	3-State

## MAXIMUM RATINGS

Symbol	Rating	Value	Condition	Unit
V <sub>CCA</sub> , V <sub>CCB</sub>	DC Supply Voltage	-0.5 to +5.5		V
V <sub>I</sub>	DC Input Voltage A <sub>n</sub>	-0.5 to +5.5		V
V <sub>C</sub>	Control Input $\overline{OE}$	-0.5 to +5.5		V
V <sub>O</sub>	DC Output Voltage (Power Down) B <sub>n</sub>	-0.5 to +5.5	V <sub>CCA</sub> = V <sub>CCB</sub> = 0	V
	(Active Mode) B <sub>n</sub>	-0.5 to +5.5		V
	(Tri-State Mode) B <sub>n</sub>	-0.5 to +5.5		V
I <sub>IK</sub>	DC Input Diode Current	-20	V <sub>I</sub> < GND	mA
I <sub>OK</sub>	DC Output Diode Current	-50	V <sub>O</sub> < GND	mA
I <sub>O</sub>	DC Output Source/Sink Current	±50		mA
I <sub>CCA</sub> , I <sub>CCB</sub>	DC Supply Current Per Supply Pin	±100		mA
I <sub>GND</sub>	DC Ground Current per Ground Pin	±100		mA
T <sub>STG</sub>	Storage Temperature	-65 to +150		°C

Stresses exceeding Maximum Ratings may damage the device. Maximum Ratings are stress ratings only. Functional operation above the Recommended Operating Conditions is not implied. Extended exposure to stresses above the Recommended Operating Conditions may affect device reliability.

## RECOMMENDED OPERATING CONDITIONS

Symbol	Parameter	Min	Max	Unit
V <sub>CCA</sub> , V <sub>CCB</sub>	Positive DC Supply Voltage	0.9	4.5	V
V <sub>I</sub>	Bus Input Voltage	GND	4.5	V
V <sub>C</sub>	Control Input $\overline{OE}$	GND	4.5	V
V <sub>IO</sub>	Bus Output Voltage (Power Down Mode) B <sub>n</sub>	GND	4.5	V
	(Active Mode) B <sub>n</sub>	GND	V <sub>CCB</sub>	V
	(Tri-State Mode) B <sub>n</sub>	GND	4.5	V
T <sub>A</sub>	Operating Temperature Range	-40	+85	°C
Δt / ΔV	Input Transition Rise or Rate V <sub>I</sub> , from 30% to 70% of V <sub>CC</sub> ; V <sub>CC</sub> = 3.3 V ±0.3 V	0	10	nS

# NLSV8T240

## DC ELECTRICAL CHARACTERISTICS

Symbol	Parameter	Test Conditions	V <sub>CCA</sub> (V)	V <sub>CCB</sub> (V)	-40°C to +85°C		Unit
					Min	Max	
V <sub>IH</sub>	Input HIGH Voltage (An, OE)		3.6 – 4.5	0.9 – 4.5	2.2	–	V
			2.7 – 3.6		2.0	–	
			2.3 – 2.7		1.6	–	
			1.4 – 2.3		0.65 * V <sub>CCA</sub>	–	
			0.9 – 1.4		0.9 * V <sub>CCA</sub>	–	
V <sub>IL</sub>	Input LOW Voltage (An, OE)		3.6 – 4.5	0.9 – 4.5	–	0.8	V
			2.7 – 3.6		–	0.8	
			2.3 – 2.7		–	0.7	
			1.4 – 2.3		–	0.35 * V <sub>CCA</sub>	
			0.9 – 1.4		–	0.1 * V <sub>CCA</sub>	
V <sub>OH</sub>	Output HIGH Voltage	I <sub>OH</sub> = -100 μA; V <sub>I</sub> = V <sub>IL</sub>	0.9 – 4.5	0.9 – 4.5	V <sub>CCB</sub> - 0.2	–	V
		I <sub>OH</sub> = -0.5 mA; V <sub>I</sub> = V <sub>IL</sub>	0.9	0.9	0.75 * V <sub>CCB</sub>	–	
		I <sub>OH</sub> = -2 mA; V <sub>I</sub> = V <sub>IL</sub>	1.4	1.4	1.05	–	
		I <sub>OH</sub> = -6 mA; V <sub>I</sub> = V <sub>IL</sub>	1.65	1.65	1.25	–	
			2.3	2.3	2.0	–	
		I <sub>OH</sub> = -12 mA; V <sub>I</sub> = V <sub>IL</sub>	2.3	2.3	1.8	–	
			2.7	2.7	2.2	–	
		I <sub>OH</sub> = -18 mA; V <sub>I</sub> = V <sub>IL</sub>	2.3	2.3	1.7	–	
3.0	3.0		2.4	–			
V <sub>OL</sub>	Output LOW Voltage	I <sub>OL</sub> = 100 μA; V <sub>I</sub> = V <sub>IH</sub>	0.9 – 4.5	0.9 – 4.5	–	0.2	V
		I <sub>OL</sub> = 0.5 mA; V <sub>I</sub> = V <sub>IH</sub>	1.1	1.1	–	0.3	
		I <sub>OL</sub> = 2 mA; V <sub>I</sub> = V <sub>IH</sub>	1.4	1.4	–	0.35	
		I <sub>OL</sub> = 6 mA; V <sub>I</sub> = V <sub>IH</sub>	1.65	1.65	–	0.3	
			2.3	2.3	–	0.4	
		I <sub>OL</sub> = 12 mA; V <sub>I</sub> = V <sub>IH</sub>	2.7	2.7	–	0.4	
			2.3	2.3	–	0.6	
		I <sub>OL</sub> = 18 mA; V <sub>I</sub> = V <sub>IH</sub>	3.0	3.0	–	0.4	
3.0	3.0		–	0.55			
I <sub>I</sub>	Input Leakage Current	V <sub>I</sub> = V <sub>CCA</sub> or GND	0.9 – 4.5	0.9 – 4.5	-1.0	1.0	μA
I <sub>OFF</sub>	Power-Off Leakage Current	OE = 0 V	0 0.9 – 4.5	0.9 – 4.5 0	-1.0 -1.0	1.0 1.0	μA
I <sub>CCA</sub>	Quiescent Supply Current	V <sub>I</sub> = V <sub>CCA</sub> or GND; I <sub>O</sub> = 0, V <sub>CCA</sub> = V <sub>CCB</sub>	0.9 – 4.5	0.9 – 4.5	–	2.0	μA
I <sub>CCB</sub>	Quiescent Supply Current	V <sub>I</sub> = V <sub>CCA</sub> or GND; I <sub>O</sub> = 0, V <sub>CCA</sub> = V <sub>CCB</sub>	0.9 – 4.5	0.9 – 4.5	–	2.0	μA
I <sub>CCA</sub> + I <sub>CCB</sub>	Quiescent Supply Current	V <sub>I</sub> = V <sub>CCA</sub> or GND; I <sub>O</sub> = 0, V <sub>CCA</sub> = V <sub>CCB</sub>	0.9 – 4.5	0.9 – 4.5	–	4.0	μA
ΔI <sub>CCA</sub>	Increase in I <sub>CC</sub> per Input Voltage, Other Inputs at V <sub>CCA</sub> or GND	V <sub>I</sub> = V <sub>CCA</sub> - 0.6 V; V <sub>I</sub> = V <sub>CCA</sub> or GND	4.5	4.5	–	10	μA
			3.6	3.6	–	5.0	
ΔI <sub>CCB</sub>	Increase in I <sub>CC</sub> per Input Voltage, Other Inputs at V <sub>CCA</sub> or GND	V <sub>I</sub> = V <sub>CCA</sub> - 0.6 V; V <sub>I</sub> = V <sub>CCA</sub> or GND	4.5	4.5	–	10	μA
			3.6	3.6	–	5.0	
I <sub>OZ</sub>	I/O Tri-State Output Leakage Current	T <sub>A</sub> = 25°C, OE = 0 V	0.9 – 4.5	0.9 – 4.5	-1.0	1.0	μA

# NLSV8T240

## TOTAL STATIC POWER CONSUMPTION ( $I_{CCA} + I_{CCB}$ )

$V_{CCA}$ (V)	-40°C to +85°C										Unit
	$V_{CCB}$ (V)										
	4.5		3.3		2.8		1.8		0.9		
	Min	Max	Min	Max	Min	Max	Min	Max	Min	Max	
4.5		2		2		2		2		< 1.5	$\mu$ A
3.3		2		2		2		2		< 1.5	$\mu$ A
2.8		< 2		< 1		< 1		< 0.5		< 0.5	$\mu$ A
1.8		< 1		< 1		< 0.5		< 0.5		< 0.5	$\mu$ A
0.9		< 0.5		< 0.5		< 0.5		< 0.5		< 0.5	$\mu$ A

NOTE: Connect ground before applying supply voltage  $V_{CCA}$  or  $V_{CCB}$ . This device is designed with the feature that the power-up sequence of  $V_{CCA}$  and  $V_{CCB}$  will not damage the IC.

## AC ELECTRICAL CHARACTERISTICS

Symbol	Parameter	$V_{CCA}$ (V)	-40°C to +85°C										Unit
			$V_{CCB}$ (V)										
			4.5		3.3		2.8		1.8		1.2		
			Min	Max	Min	Max	Min	Max	Min	Max	Min	Max	
$t_{PLH}$ , $t_{PHL}$ (Note 1)	Propagation Delay, $A_n$ to $B_n$	4.5		1.6		1.8		2.0		2.1		2.3	nS
		3.3		1.7		1.9		2.1		2.3		2.6	
		2.8		1.9		2.1		2.3		2.5		2.8	
		1.8		2.1		2.4		2.5		2.7		3.0	
		1.2		2.4		2.7		2.8		3.0		3.3	
$t_{PZH}$ , $t_{PZL}$ (Note 1)	Output Enable, $\overline{OE}$ to $B_n$	4.5		2.6		3.8		4.0		4.1		4.3	nS
		3.3		3.7		3.9		4.1		4.3		4.6	
		2.5		3.9		4.1		4.3		4.5		4.8	
		1.8		4.1		4.4		4.5		4.7		5.0	
		1.2		4.4		4.7		4.8		5.0		5.3	
$t_{PHZ}$ , $t_{PLZ}$ (Note 1)	Output Disable, $\overline{OE}$ to $B_n$	4.5		2.6		3.8		4.0		4.1		4.3	nS
		3.3		3.7		3.9		4.1		4.3		4.6	
		2.5		3.9		4.1		4.3		4.5		4.8	
		1.8		4.1		4.4		4.5		4.7		5.0	
		1.2		4.4		4.7		4.8		5.0		5.3	
$t_{OSHL}$ , $t_{OSLH}$ (Note 1)	Output to Output Skew, Time	4.5		0.15		0.15		0.15		0.15		0.15	nS
		3.3		0.15		0.15		0.15		0.15		0.15	
		2.5		0.15		0.15		0.15		0.15		0.15	
		1.8		0.15		0.15		0.15		0.15		0.15	
		1.2		0.15		0.15		0.15		0.15		0.15	

1. Propagation delays defined per Figure 2.

## CAPACITANCE

Symbol	Parameter	Test Conditions	Typ (Note 2)	Unit
$C_{IN}$	Control Pin Input Capacitance	$V_{CCA} = V_{CCB} = 3.3$ V, $V_I = 0$ V or $V_{CCA/B}$	3.5	pF
$C_{I/O}$	I/O Pin Input Capacitance	$V_{CCA} = V_{CCB} = 3.3$ V, $V_I = 0$ V or $V_{CCA/B}$	5.0	pF
$C_{PD}$	Power Dissipation Capacitance	$V_{CCA} = V_{CCB} = 3.3$ V, $V_I = 0$ V or $V_{CCA}$ , $f = 10$ MHz	20	pF

2. Typical values are at  $T_A = +25^\circ\text{C}$ .

3.  $C_{PD}$  is defined as the value of the IC's equivalent capacitance from which the operating current can be calculated from:  
 $I_{CC(\text{operating})} \cong C_{PD} \times V_{CC} \times f_{IN} \times N_{SW}$  where  $I_{CC} = I_{CCA} + I_{CCB}$  and  $N_{SW}$  = total number of outputs switching.

# NLSV8T240



Figure 2. AC (Propagation Delay) Test Circuit

Test	Switch
$t_{PLH}$ , $t_{PHL}$	OPEN
$t_{PLZ}$ , $t_{PZL}$	$V_{CC} \times 2$
$t_{PHZ}$ , $t_{PZH}$	GND

$C_L = 15 \text{ pF}$  or equivalent (includes probe and jig capacitance)  
 $R_L = 2 \text{ k}\Omega$  or equivalent  
 $Z_{OUT}$  of pulse generator =  $50 \Omega$

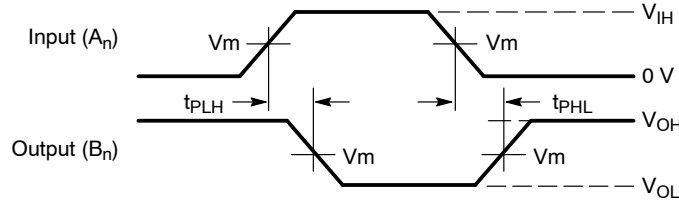

Waveform 1 - Propagation Delays

$t_R = t_F = 2.0 \text{ ns}$ , 10% to 90%;  $f = 1 \text{ MHz}$ ;  $t_W = 500 \text{ ns}$



Waveform 2 - Output Enable and Disable Times

$t_R = t_F = 2.0 \text{ ns}$ , 10% to 90%;  $f = 1 \text{ MHz}$ ;  $t_W = 500 \text{ ns}$

Figure 3. AC (Propagation Delay) Test Circuit Waveforms

Symbol	$V_{CC}$				
	3.0 V - 4.5 V	2.3 V - 2.7 V	1.65 V - 1.95 V	1.4 V - 1.6 V	0.9 V - 1.3 V
$V_{mA}$	$V_{CCA}/2$	$V_{CCA}/2$	$V_{CCA}/2$	$V_{CCA}/2$	$V_{CCA}/2$
$V_{mB}$	$V_{CCB}/2$	$V_{CCB}/2$	$V_{CCB}/2$	$V_{CCB}/2$	$V_{CCB}/2$
$V_X$	$V_{OL} \times 0.1$	$V_{OL} \times 0.1$	$V_{OL} \times 0.1$	$V_{OL} \times 0.1$	$V_{OL} \times 0.1$
$V_Y$	$V_{OH} \times 0.9$	$V_{OH} \times 0.9$	$V_{OH} \times 0.9$	$V_{OH} \times 0.9$	$V_{OH} \times 0.9$

# MECHANICAL CASE OUTLINE

## PACKAGE DIMENSIONS

ON Semiconductor®



UDFN20 4x2, 0.4P  
CASE 517AK-01  
ISSUE O

DATE 14 NOV 2006

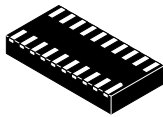

SCALE 4:1

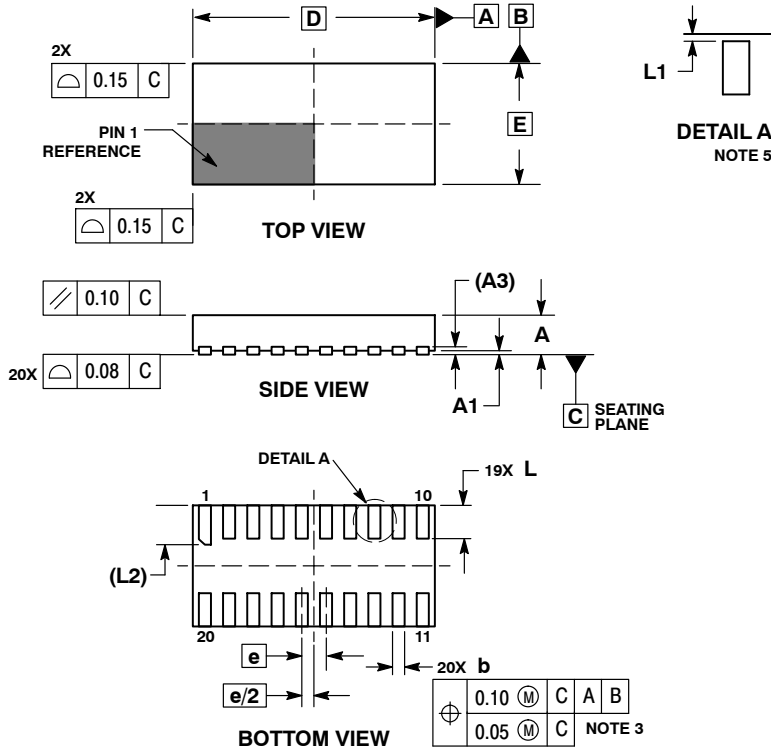

NOTES:

1. DIMENSIONING AND TOLERANCING PER ASME Y14.5M, 1994.
2. CONTROLLING DIMENSION: MILLIMETERS.
3. DIMENSIONS b APPLIES TO PLATED TERMINAL AND IS MEASURED BETWEEN 0.15 AND 0.30 MM FROM TERMINAL TIP.
4. MOLD FLASH ALLOWED ON TERMINALS ALONG EDGE OF PACKAGE. FLASH MAY NOT EXCEED 0.03 ONTO BOTTOM SURFACE OF TERMINALS.
5. DETAIL A SHOWS OPTIONAL CONSTRUCTION FOR TERMINALS.

DIM	MILLIMETERS	
	MIN	MAX
A	0.45	0.55
A1	0.00	0.05
A3	0.13 REF	
b	0.15	0.25
D	4.00 BSC	
E	2.00 BSC	
e	0.40 BSC	
L	0.50	0.60
L1	0.00	0.03
L2	0.60	0.70

**GENERIC MARKING DIAGRAM\***

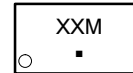

- XX = Specific Device Code
- M = Date Code
- = Pb-Free Package

\*This information is generic. Please refer to device data sheet for actual part marking. Pb-Free indicator, "G" or microdot "■", may or may not be present.

**MOUNTING FOOTPRINT**  
**SOLDERMASK DEFINED**

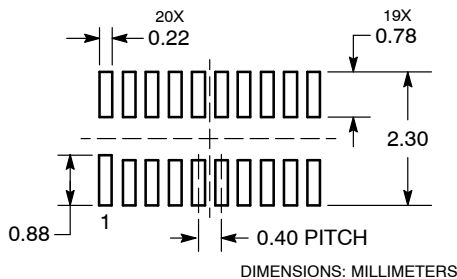

<b>DOCUMENT NUMBER:</b>	<b>98AON23419D</b>	Electronic versions are uncontrolled except when accessed directly from the Document Repository. Printed versions are uncontrolled except when stamped "CONTROLLED COPY" in red.
<b>DESCRIPTION:</b>	<b>UDFN20 4 X 2, 0.4P</b>	<b>PAGE 1 OF 1</b>

ON Semiconductor and ON are trademarks of Semiconductor Components Industries, LLC dba ON Semiconductor or its subsidiaries in the United States and/or other countries. ON Semiconductor reserves the right to make changes without further notice to any products herein. ON Semiconductor makes no warranty, representation or guarantee regarding the suitability of its products for any particular purpose, nor does ON Semiconductor assume any liability arising out of the application or use of any product or circuit, and specifically disclaims any and all liability, including without limitation special, consequential or incidental damages. ON Semiconductor does not convey any license under its patent rights nor the rights of others.

**onsemi**, **Onsemi**, and other names, marks, and brands are registered and/or common law trademarks of Semiconductor Components Industries, LLC dba "**onsemi**" or its affiliates and/or subsidiaries in the United States and/or other countries. **onsemi** owns the rights to a number of patents, trademarks, copyrights, trade secrets, and other intellectual property. A listing of **onsemi**'s product/patent coverage may be accessed at [www.onsemi.com/site/pdf/Patent-Marking.pdf](http://www.onsemi.com/site/pdf/Patent-Marking.pdf). **onsemi** reserves the right to make changes at any time to any products or information herein, without notice. The information herein is provided "as-is" and **onsemi** makes no warranty, representation or guarantee regarding the accuracy of the information, product features, availability, functionality, or suitability of its products for any particular purpose, nor does **onsemi** assume any liability arising out of the application or use of any product or circuit, and specifically disclaims any and all liability, including without limitation special, consequential or incidental damages. Buyer is responsible for its products and applications using **onsemi** products, including compliance with all laws, regulations and safety requirements or standards, regardless of any support or applications information provided by **onsemi**. "Typical" parameters which may be provided in **onsemi** data sheets and/or specifications can and do vary in different applications and actual performance may vary over time. All operating parameters, including "Typicals" must be validated for each customer application by customer's technical experts. **onsemi** does not convey any license under any of its intellectual property rights nor the rights of others. **onsemi** products are not designed, intended, or authorized for use as a critical component in life support systems or any FDA Class 3 medical devices or medical devices with a same or similar classification in a foreign jurisdiction or any devices intended for implantation in the human body. Should Buyer purchase or use **onsemi** products for any such unintended or unauthorized application, Buyer shall indemnify and hold **onsemi** and its officers, employees, subsidiaries, affiliates, and distributors harmless against all claims, costs, damages, and expenses, and reasonable attorney fees arising out of, directly or indirectly, any claim of personal injury or death associated with such unintended or unauthorized use, even if such claim alleges that **onsemi** was negligent regarding the design or manufacture of the part. **onsemi** is an Equal Opportunity/Affirmative Action Employer. This literature is subject to all applicable copyright laws and is not for resale in any manner.

## PUBLICATION ORDERING INFORMATION

### LITERATURE FULFILLMENT:

Email Requests to: [orderlit@onsemi.com](mailto:orderlit@onsemi.com)

**onsemi Website:** [www.onsemi.com](http://www.onsemi.com)

### TECHNICAL SUPPORT

**North American Technical Support:**

Voice Mail: 1 800-282-9855 Toll Free USA/Canada

Phone: 011 421 33 790 2910

**Europe, Middle East and Africa Technical Support:**

Phone: 00421 33 790 2910

For additional information, please contact your local Sales Representative