

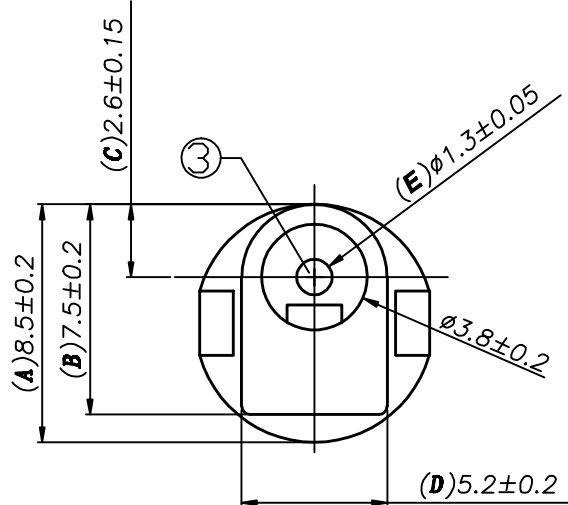

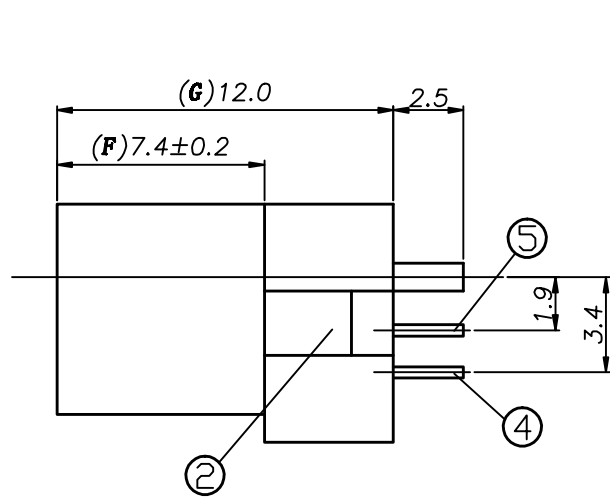

HAOYU

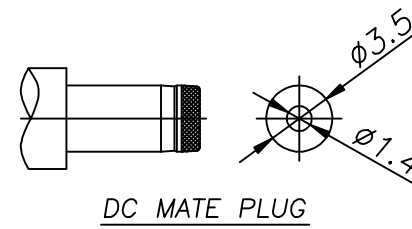
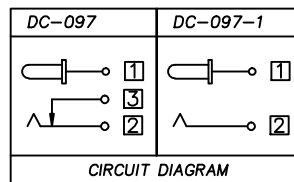
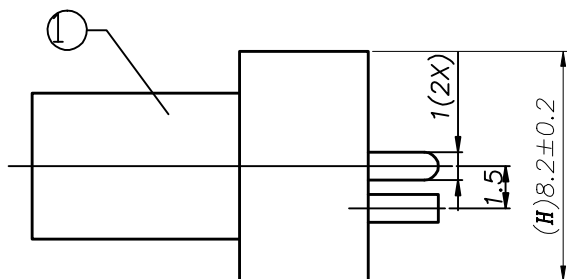
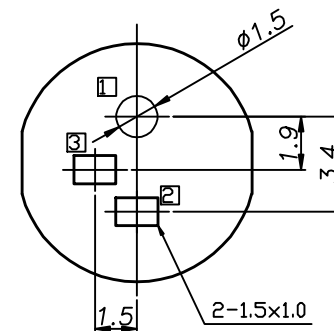

P. C. B Layout (Top view)



					TOLERANCE UNLESS SPECIFIED									
					UP TO 5mm: ±0.1	ANGULAR	1							
					ABOVE 5mm: ±0.2	±1°	NO	DATE	REVISIONS		BY	APPD		
5	FLAT PIECE	BRASS	1	Au PLATED	TITLE:DC JACK		UNIT : MM	ROHS	DWN					
4	SPRING	PHOSPHOR BRONZE	1	Au PLATED	MODEL:DC-097		SCALE: 4:1	COMPLIANT	CHK'D					
3	PIN	BRASS	1	Au PLATED	 HAOYU(HONGKONG)LIMITED 皓宇(香港)有限公司							APPD		
2	COVER	PA66	1	BLACK								PRO.AGL:		
1	CASE	PA66	1	BLACK										
NO.	PART	NAME	MATERIAL	QTY	FINISHING									